

## CZRA4728-HF Thru. CZRA4755-HF

Voltage: 3.3 to 43 Volts

Power: 1.0 Watts

RoHS Device

Halogen Free

### Features

- Batch process design, excellent power dissipation offers better reverse leakage current and thermal resistance.
- Glass passivated chip junction.
- Typical IR less than 0.5 $\mu$ A above 11V.
- Standard zener voltage tolerance  $\pm$ 5%.
- Low inductance.

### Mechanical data

- Epoxy: UL94-V0 rated flame retardant.
- Case: Molded plastic, JEDEC DO-214AC/SMA.
- Terminals: Solder Plated, solderable per MIL-STD-750, method 2026.
- Polarity: Indicated by Cathode band.
- Mounting position: Any.
- Weight: 0.05 gram (approx.).

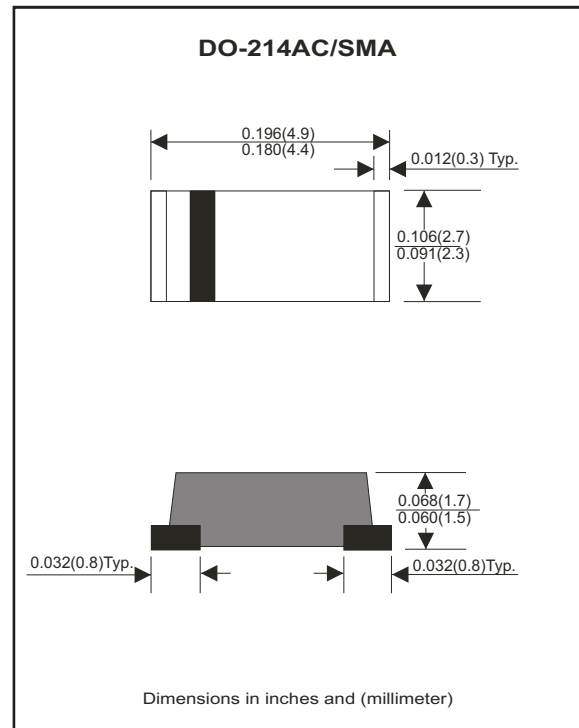

### Maximum Rating And Electrical Characteristics

( $T_A=25^{\circ}\text{C}$ , unless otherwise noted)

Parameter	Condition	Symbol	MIN.	TYP.	MAX.	Units
Forward voltage	$I_F = 200 \text{ mA DC}$	$V_F$			1.20	V
Power Dissipation		$P_D$			1000	V
Peak surge forward current	8.3ms single half sine-wave superimposed on rate load (JEDEC method)	$I_{FSM}$			100	A
Thermal resistance	Junction to case	$R_{\theta JC}$		100		$^{\circ}\text{C/W}$
	Junction to ambient	$R_{\theta JA}$		110		$^{\circ}\text{C/W}$
Storage temperature		$T_J$	-65		+175	$^{\circ}\text{C}$
Operating temperature		$T_J$	-55		+150	$^{\circ}\text{C}$

# SMD Zener Diode



SMD Diodes Specialist

## Electrical Characteristics ( at T<sub>A</sub> = 25°C unless otherwise noted)

Part Number	Marking Code	Zener Voltage	Test Current	Zener Impedance			Leakage Current		Surge Current
		V <sub>Z</sub> @I <sub>ZT</sub>	I <sub>ZT</sub>	Z <sub>ZT</sub> @ I <sub>ZT</sub>	Z <sub>ZK</sub> @ I <sub>ZK</sub>	I <sub>ZK</sub>	I <sub>R</sub>	V <sub>R</sub>	I <sub>surge</sub>
		Volts	mA	ohMs	ohMs	mA	uA	Volts	mA
CZRA4728-HF	Z3V3	3.3	76	10	400	1.0	100	1.0	1380
CZRA4729-HF	Z3V6	3.6	69	10	400	1.0	100	1.0	1260
CZRA4730-HF	Z3V9	3.9	64	9	400	1.0	50	1.0	1190
CZRA4731-HF	Z4V3	4.3	58	9	400	1.0	10	1.0	1070
CZRA4732-HF	Z4V7	4.7	53	8	500	1.0	10	1.0	970
CZRA4733-HF	Z5V1	5.1	49	7	550	1.0	10	1.0	890
CZRA4734-HF	Z5V6	5.6	45	5	600	1.0	10	2.0	810
CZRA4735-HF	Z6V2	6.2	41	2	700	1.0	10	3.0	730
CZRA4736-HF	Z6V8	6.8	37	3.5	700	1.0	10	4.0	660
CZRA4737-HF	Z7V5	7.5	34	4	700	0.5	10	5.0	605
CZRA4738-HF	Z8V2	8.2	31	4.5	700	0.5	10	6.0	550
CZRA4739-HF	Z9V1	9.1	28	5	700	0.5	10	7.0	500
CZRA4740-HF	Z10	10	25	7	700	0.25	10	7.6	454
CZRA4741-HF	Z11	11	23	8	700	0.25	5	8.4	414
CZRA4742-HF	Z12	12	21	9	700	0.25	5	9.1	380
CZRA4743-HF	Z13	13	19	10	700	0.25	5	9.9	344
CZRA4744-HF	Z15	15	17	14	700	0.25	5	11.4	304
CZRA4745-HF	Z16	16	15.5	16	700	0.25	5	12.2	285
CZRA4746-HF	Z18	18	14	20	750	0.25	5	13.7	250
CZRA4747-HF	Z20	20	12.5	22	750	0.25	5	15.2	225
CZRA4748-HF	Z22	22	11.5	23	750	0.25	5	16.7	205
CZRA4749-HF	Z24	24	10.5	25	750	0.25	5	18.2	190
CZRA4750-HF	Z27	27	9.5	35	750	0.25	5	20.6	170
CZRA4751-HF	Z30	30	8.5	40	1000	0.25	5	22.8	150
CZRA4752-HF	Z33	33	7.5	45	1000	0.25	5	25.4	135
CZRA4753-HF	Z36	36	7.0	50	1000	0.25	5	27.4	125
CZRA4754-HF	Z39	39	6.5	60	1000	0.25	5	29.7	115
CZRA4755-HF	Z43	43	6.0	70	1500	0.25	5	32.7	105

## RATING AND CHARACTERISTIC CURVES (CZRA4728-HF Thru. CZRA4755-HF)

FIG 1A. Range for Units to 12 Volts

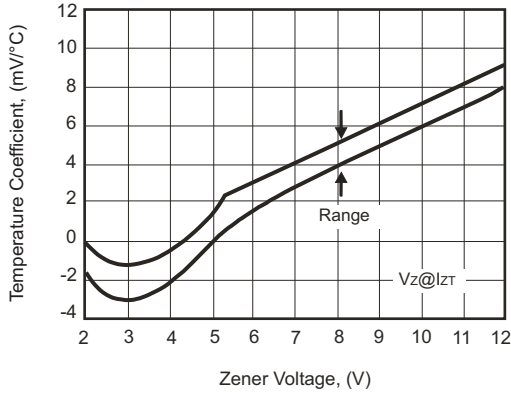

FIG 1B. Range for Units 12 to 100 Volts

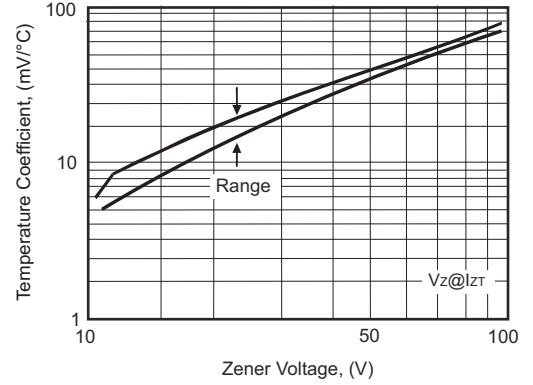

FIG 2. Temperature Coefficients (-55°C to +150°C temperature change ; 90% of the units are in the ranges indicated.)

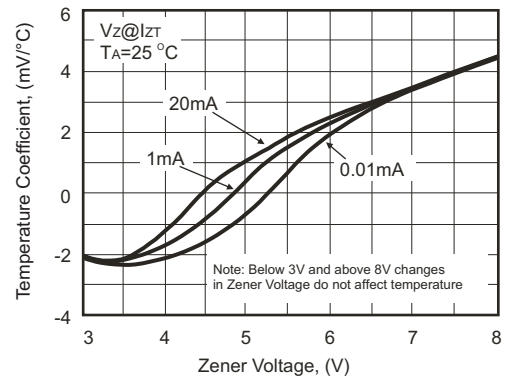
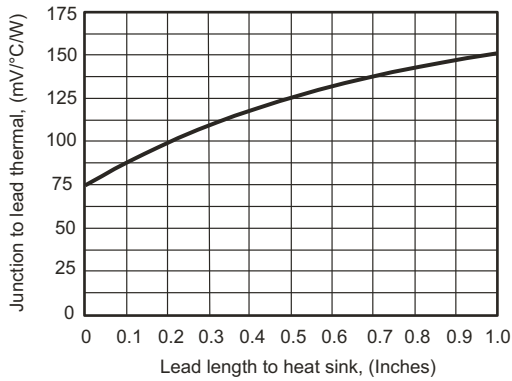

FIG 3. Typical Thermal Resistance Versus Lead

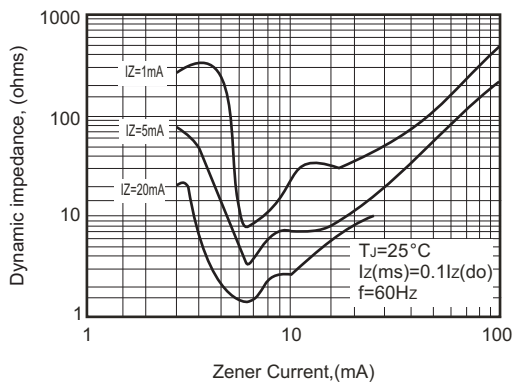
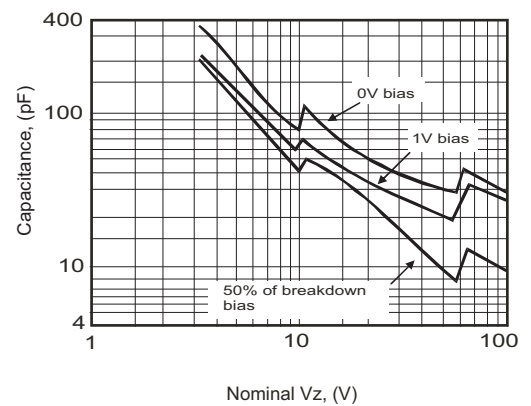
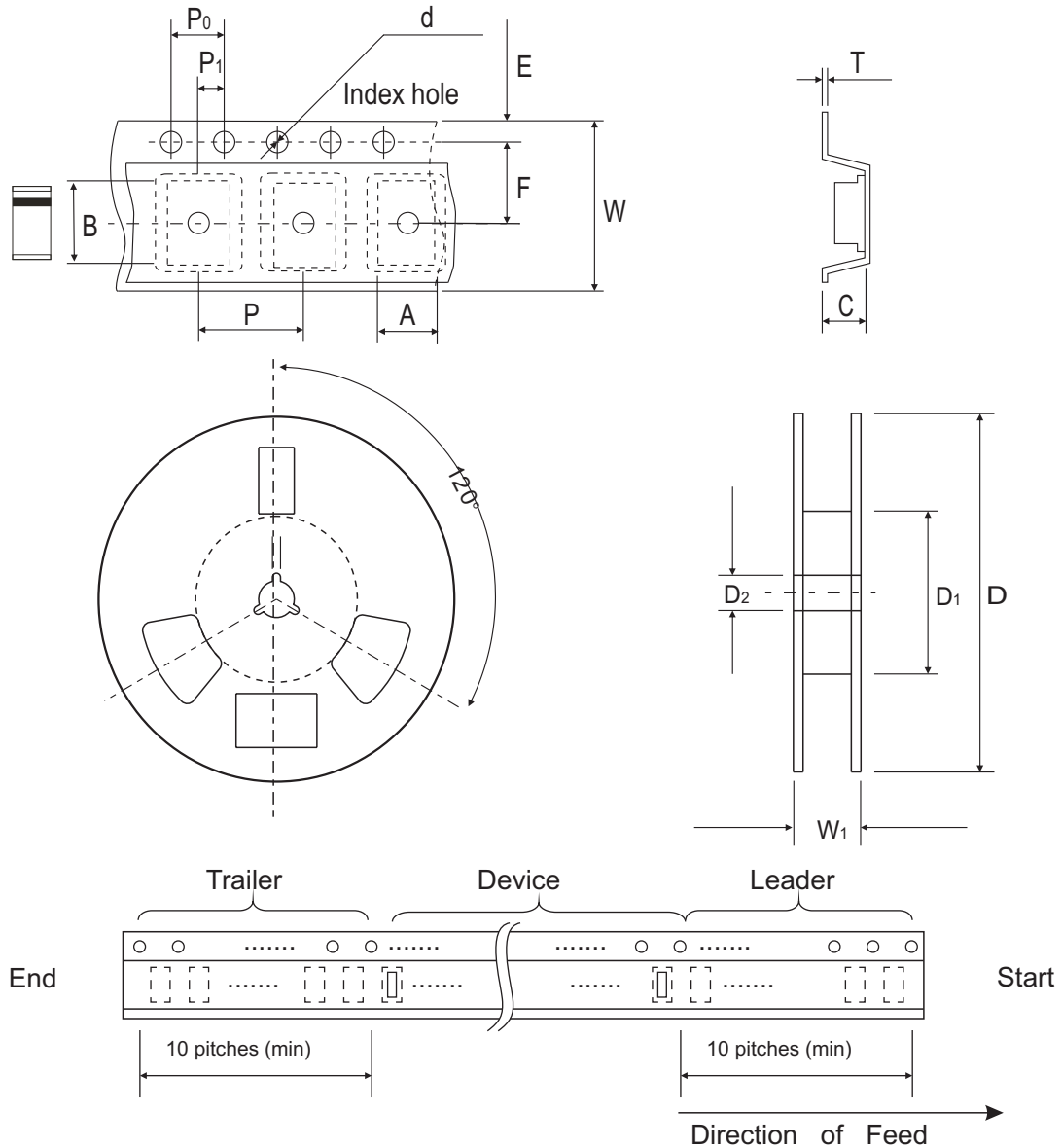

FIG 4. Effect of Zener Current



## Reel Taping Specification



DO-214AC (SMA)	SYMBOL	A	B	C	d	D	D <sub>1</sub>	D <sub>2</sub>
	(mm)	2.8 ± 0.10	5.00 ± 0.10	1.90 ± 0.10	1.50 ± 0.10	178 ± 2.00	62.0 MIN.	13.0 ± 0.50
	(inch)	0.110 ± 0.004	0.197 ± 0.004	0.075 ± 0.004	0.059 ± 0.004	7.008 ± 0.078	2.441 MIN.	0.512 ± 0.008

DO-214AC (SMA)	SYMBOL	E	F	P	P <sub>0</sub>	P <sub>1</sub>	W	W <sub>1</sub>
	(mm)	1.75 ± 0.10	5.50 ± 0.10	4.00 ± 0.10	4.00 ± 0.10	2.00 ± 0.10	12.00 ± 0.30	18.00 ± 1.00
	(inch)	0.069 ± 0.004	0.217 ± 0.002	0.157 ± 0.004	0.157 ± 0.004	0.079 ± 0.004	0.472 ± 0.012	0.709 ± 0.040

## Suggested PAD Layout

SIZE	DO-214AC (SMA)	
	(mm)	(inch)
A	3.80	0.150
B	1.60	0.063
C	2.80	0.110
D	5.40	0.213
E	2.20	0.087

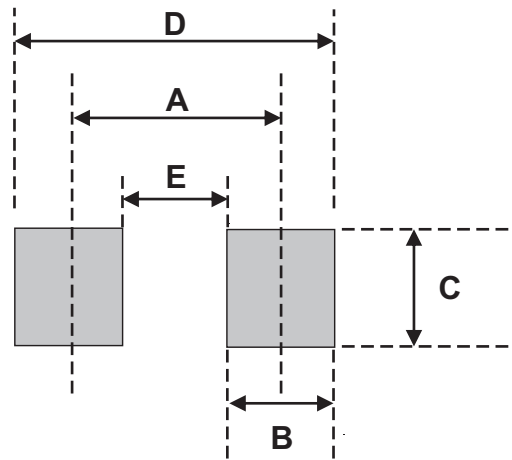

## Standard Package

Case Type	Qty per Reel	Reel Size
	(Pcs)	(inch)
DO-214AC (SMA)	2000	7