

ITEM	Q'TY	PART NUMBER	PART DESCRIPTION
1	1	MPR5	Chrome Panel Mount Holder, Recessed, 5mm
2	1	5XX-F	T-1¼ (5mm) Flanged LED, See Page 2

REV.	DESCRIPTION	DATE	APPROVED
A	Engineering Release.	04/05/05	M. C.
B	Corrected LED Lead Polarity	02/01/07	M. C.
C	Removed LEDs From Sheets 2 and 3	06/29/11	T. Y.
D	Updated LED offering	05/07/12	T. Y.
E	Corrected typo on page 4	07/16/12	T. Y.

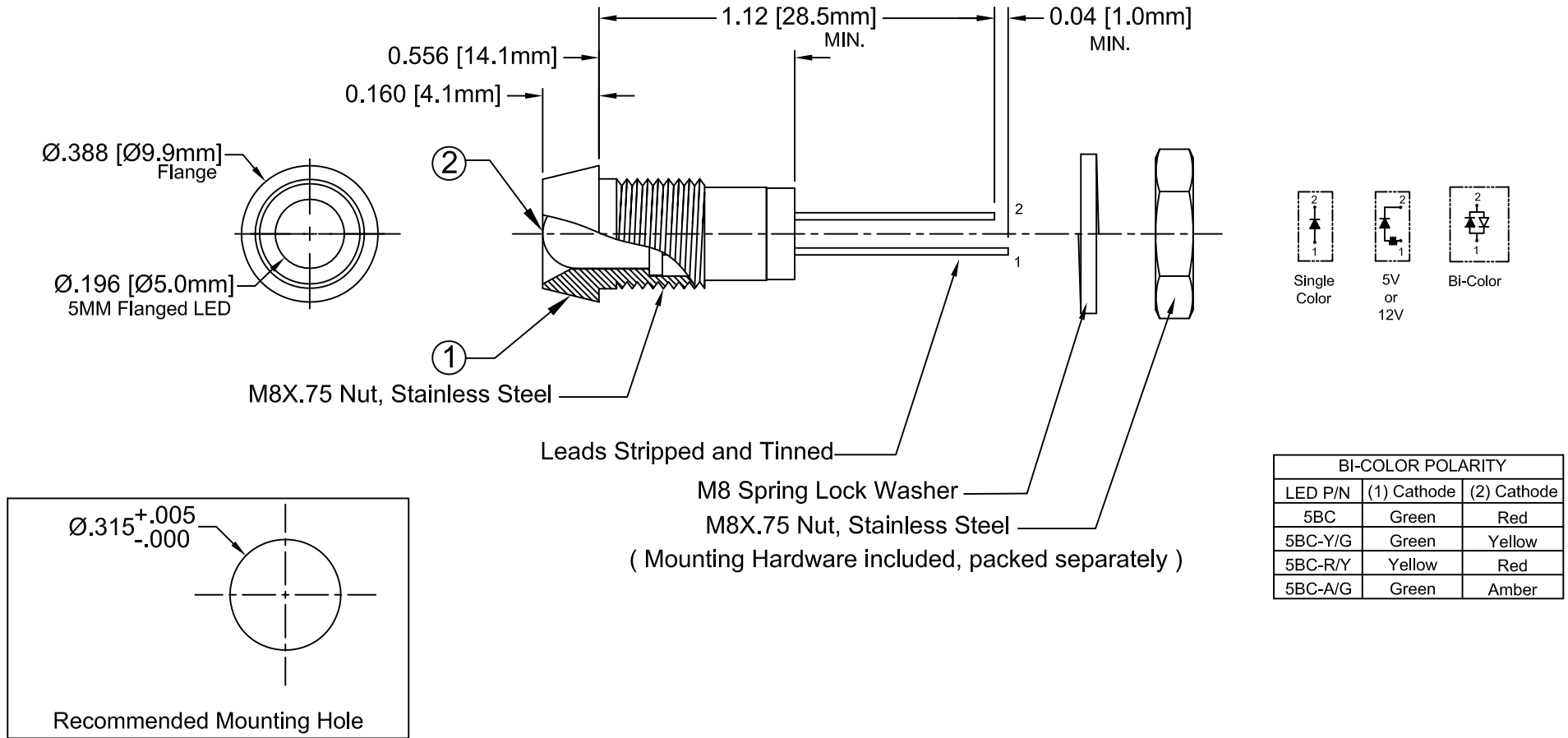

ABSOLUTE MAXIMUM RATINGS (Ta = 25°C)

REVERSE VOLTAGE _____ 5V

REVERSE CURRENT (VR=5V) _____ 100µA

OPERATING TEMPERATURE RANGE _____ -40°C ~ 85°C



STORAGE TEMPERATURE _____ -40°C ~ 100°C

LEAD SOLDERING TEMPERATURE (1/16" FROM BODY) _____ 260°C for 5 Seconds

STANDARD TOLERANCE (UNLESS OTHERWISE SPECIFIED)		 BIVAR [®] 4 THOMAS, IRVINE, CA. 92618 TEL: (949) 951-8808 FAX: (949) 951-3974
DECIMALS	ANGULAR	
.X ± .1	X° ± 1°	TITLE: STD METAL PANEL MOUNT INDICATORS PART NO: MPR5XX REVISION: E
.XX ± .02		
.XXX ± .010		
DESIGNED: David Green	DATE: 04/05/05	CAGE CODE : 32559 SHEET # 1 OF 4 CAD GENERATED DOCUMENT, DO NOT MEASURE DRAWING.
CHECKED: T. Yin	DATE: 04/05/05	



REV.	DESCRIPTION	DATE	APPROVED
	SEE SHEET#1.		

LED Assy. No.	Chip			Lens Appearance	Electro-Optical Data @ 20mA				Viewing Angle 2θ ½ (Deg)	LED P/N	
	Material	Peak Wave Length	Emitted Color		If (mA)	Vf (V)		Iv (mcd)			
						MAX	TYP	MAX			TYP
MPR5BWC	GaN/SiC	430	BLUE	WATER CLEAR	25	4	4.5	30	25	5BWC-F	
MPR5BWD	GaN/SiC	430	BLUE	DIFFUSED	25	4	4.5	15	40	5BWD-F	
MPR5BWT	GaN/SiC	430	BLUE	TINTED	25	4	4.5	30	25	5BWT-F	
MPR5GC	GaP/GaP	568	GREEN	WATER CLEAR	30	2.1	2.8	40	35	5GC-F	
MPR5GD	GaP/GaP	568	GREEN	DIFFUSED	30	2.1	2.8	25	40	5GD-F	
MPR5GT	GaP/GaP	568	GREEN	TINTED	30	2.1	2.8	40	35	5GT-F	
MPR5PGC	GaP/GaP	555	PURE GREEN	WATER CLEAR	30	2.2	2.8	10	35	5PGC-F	
MPR5PGD	GaP/GaP	555	PURE GREEN	DIFFUSED	30	2.2	2.8	10	40	5PGD-F	
MPR5PGT	GaP/GaP	555	PURE GREEN	TINTED	30	2.2	2.8	10	35	5PGT-F	
MPR5YC	GaAsP/GaP	590	YELLOW	WATER CLEAR	30	2	2.8	40	35	5YC-F	
MPR5YD	GaAsP/GaP	590	YELLOW	DIFFUSED	30	2	2.8	25	40	5YD-F	
MPR5YT	GaAsP/GaP	590	YELLOW	TINTED	30	2	2.8	40	35	5YT-F	
MPR5AC	GaAsP/GaP	605	AMBER	WATER CLEAR	30	2	2.8	40	35	5AC-F	
MPR5AD	GaAsP/GaP	605	AMBER	DIFFUSED	30	2	2.8	25	40	5AD-F	
MPR5AT	GaAsP/GaP	605	AMBER	TINTED	30	2	2.8	40	35	5AT-F	
MPR5HC	GaAsP/GaP	625	HE RED	WATER CLEAR	30	2	2.8	50	35	5HC-F	
MPR5HD	GaAsP/GaP	625	HE RED	DIFFUSED	30	2	2.8	40	40	5HD-F	
MPR5HT	GaAsP/GaP	625	HE RED	TINTED	30	2	2.8	50	35	5HT-F	
MPR5RC	GaP/GaP	700	RED	WATER CLEAR	20	2.1	2.8	2	35	5RC-F	
MPR5RD	GaP/GaP	700	RED	DIFFUSED	20	2.1	2.8	1.5	40	5RD-F	
MPR5RT	GaP/GaP	700	RED	TINTED	20	2.1	2.8	2	35	5RT-F	
MPR5BC-A/G	GaAsP/GaP	605	AMBER	DIFFUSED	30	2.0	2.8	6	45	5BC-A/G-F	
	GaP/GaP	568	GREEN		30	2.1	2.8	6			
MPR5BC	GaAsP/GaP	625	RED	DIFFUSED	30	2.0	2.8	8	45	5BC-F	
	GaP/GaP	568	GREEN		30	2.1	2.8	8			
MPR5BC-R/Y	GaAsP/GaP	625	RED	DIFFUSED	30	2.0	2.8	8	45	5BC-R/Y-F	
	GaAsP/GaP	590	YELLOW		30	2.0	2.8	6			
MPR5BC-Y/G	GaAsP/GaP	590	YELLOW	DIFFUSED	30	2.0	2.8	6	45	5BC-Y/G-F	
	GaP/GaP	568	GREEN		30	2.1	2.8	8			

STANDARD TOLERANCE (UNLESS OTHERWISE SPECIFIED) ±10% ALL VALUES		 BIVAR [®] 4 THOMAS, IRVINE, CA. 92618 TEL: (949) 951-8808 FAX: (949) 951-3974	
ANGULAR X° ± 5°			
		TITLE: STD METAL PANEL MOUNT INDICATORS	
DESIGNED: David Green	DATE: 04/05/05	PART NO: MPR5XX	REVISION: E
CHECKED: T. Yin	DATE: 04/05/05	CAGE CODE : 32559	SHEET # 2 OF 4
CAD GENERATED DOCUMENT, DO NOT MEASURE DRAWING.			

REV.	DESCRIPTION	DATE	APPROVED
	SEE SHEET#1.		



LED Assy. No.	Chip			Lens Appearance	Electro-Optical Data @ 20mA				Viewing Angle 2 θ ½ (Deg)	LED P/N
	Material	Peak Wave Length	Emitted Color		If (mA)	Vf (V)		Iv (mcd)		
						MAX	TYP			
MPR5UBWC	InGaN/SiC	468	BLUE	WATER CLEAR	76	3.7	4.5	2500	15	5BWC2.515F
MPR5SGC	GaP/GaP	568	GREEN	WATER CLEAR	30	2.1	2.8	60	35	5SGC-F
MPR5SGD	GaP/GaP	568	GREEN	DIFFUSED	30	2.1	2.8	50	40	5SGD-F
MPR5SGT	GaP/GaP	568	GREEN	TINTED	30	2.1	2.8	60	35	5SGT-F
MPR5SYC	GaAsP/GaP	590	YELLOW	WATER CLEAR	30	2.0	2.8	600	35	5SYC-F
MPR5SYD	GaAsP/GaP	590	YELLOW	DIFFUSED	30	2.0	2.8	150	40	5SYD-F
MPR5SYT	GaAsP/GaP	590	YELLOW	TINTED	30	2.0	2.8	600	35	5SYT-F
MPR5SRC	GaAlAs/GaAs	645	SUPER RED	WATER CLEAR	30	1.7	2.4	60	35	5SRC-F
MPR5SRD	GaAlAs/GaAs	645	SUPER RED	DIFFUSED	30	1.7	2.4	40	40	5SRD-F
MPR5SRT	GaAlAs/GaAs	645	SUPER RED	TINTED	30	1.7	2.4	60	35	5SRT-F
MPR5UGC	AlGaInP	570	GREEN	WATER CLEAR	30	2.1	2.4	400	35	5UGC-F
MPR5SUGC	AlGaInP	570	GREEN	WATER CLEAR	30	2.1	2.4	300	35	5SUGC-F
MPR5UYC	AlGaInP	590	YELLOW	WATER CLEAR	30	2.0	2.4	1000	30	5UYC-F
MPR5SUYC	AlGaInP	590	YELLOW	WATER CLEAR	30	2.0	2.4	700	35	5SUYC-F
MPR5UUYC	AlGaInP	590	YELLOW	WATER CLEAR	30	2.0	2.4	500	35	5UUYC-F
MPR5UOC	AlGaInP	625	ORANGE	WATER CLEAR	30	1.8	2.4	1400	35	5UOC-F
MPR5UOC	AlGaInP	625	ORANGE	WATER CLEAR	30	1.8	2.4	1300	35	5SUOC-F
MPR5URC	GaAlAs/GaAs	645	RED	WATER CLEAR	30	1.7	2.4	400	30	5URC-F
MPR5SURC	AlGaInP	640	RED	WATER CLEAR	30	1.8	2.4	500	35	5SURC-F
MPR5UWC	InGaN/SiC	6500K	WHITE	WATER CLEAR	100	3.5	4.2	2700	30	5WC2.730F

STANDARD TOLERANCE (UNLESS OTHERWISE SPECIFIED) ±10% ALL VALUES		 BIVAR [®] 4 THOMAS, IRVINE, CA. 92618 TEL: (949) 951-8808 FAX: (949) 951-3974	
ANGULAR X° ± 5°			
		TITLE: STD METAL PANEL MOUNT INDICATORS	
		DESIGNED: David Green	DATE: 04/05/05
CHECKED: T. Yin		DATE: 04/05/05	CAGE CODE : 32559 SHEET # 3 OF 4
CAD GENERATED DOCUMENT, DO NOT MEASURE DRAWING.			

REV.	DESCRIPTION	DATE	APPROVED
	SEE SHEET#1.		

LED Assy. No.	Chip			Lens Appearance	Absolute Max. Ratings			Electro-Optical Data @ 2mA			Viewing Angle 2θ 1/2 (Deg)	LED P/N
	Material	Peak Wave Length λp(nm)	Emitted Color		Pd (mW)	If (mA)	Peak If(mA)	Vf (V)		Iv (mcd)		
								TYP	MAX	TYP		
MPR5BWDL	GaN/siC	430	BLUE	DIFFUSED	20	7	-	3.8	4.2	4.0	40	5BWDL-F
MPR5GDLD	GaP/GaP	568	GREEN	DIFFUSED	10	7	-	2.1	2.6	4.0	40	5GDLD-F
MPR5PGDL	GaP/GaP	555	PURE GREEN	DIFFUSED	10	7	-	2.1	2.6	1.0	40	5PGDL-F
MPR5YDL	GaAsP/GaP	590	YELLOW	DIFFUSED	10	7	-	2.0	2.6	4.0	40	5YDL-F
MPR5ADL	GaAsP/GaP	605	AMBER	DIFFUSED	10	7	-	2.0	2.6	4.0	40	5ADL-F
MPR5HDL	GaAsP/GaP	625	HE RED	DIFFUSED	10	7	-	2.0	2.6	5.0	40	5HDL-F
MPR5RDL	GaP/GaP	700	RED	DIFFUSED	10	7	-	2.1	2.6	0.5	40	5RDL-F

Assembly P/N	Peak Wave Length λp(nm)	Emitted Color	Lens Appearance	Electro-Optical Data				Viewing Angle 2θ 1/2 (Deg)	LED P/N
				If (mA)	Vf (V)		Iv (mcd)		
					MAX	TYP			
5 Volt				Data @ 5V					
MPR5BWD5V	BLUE	430	DIFFUSED	-	-	5	15	40	5BWD5V-F
MPR5GC5V	GREEN	568	WATER CLEAR	-	-	5	40	40	5GC5V-F
MPR5GD5V	GREEN	568	DIFFUSED	-	-	5	25	40	5GD5V-F
MPR5GT5V	GREEN	568	TINTED	-	-	5	40	40	5GT5V-F
MPR5AD5V	AMBER	605	DIFFUSED	-	-	5	25	40	5AD5V-F
MPR5HD5V	HE RED	625	DIFFUSED	-	-	5	30	40	5HD5V-F
MPR5RD5V	RED	700	DIFFUSED	-	-	5	1.5	40	5RD5V-F
MPR5YD5V	YELLOW	590	DIFFUSED	-	-	5	25	40	5YD5V-F
12 Volt				Data @ 12V					
MPR5GC12V	GREEN	568	WATER CLEAR	-	-	12	40	35	5GC12V-F
MPR5GD12V	GREEN	568	DIFFUSED	-	-	12	25	40	5GD12V-F
MPR5HC12V	HE RED	625	WATER CLEAR	-	-	12	50	35	5HC12V-F
MPR5HD12V	HE RED	625	DIFFUSED	-	-	12	30	40	5HD12V-F
MPR5RC12V	RED	700	WATER CLEAR	-	-	12	2	35	5RC12V-F
MPR5RD12V	RED	700	DIFFUSED	-	-	12	1.5	40	5RD12V-F
MPR5YC12V	YELLOW	590	WATER CLEAR	-	-	12	25	35	5YC12V-F
MPR5YD12V	YELLOW	590	DIFFUSED	-	-	12	20	40	5YD12V-F

STANDARD TOLERANCE (UNLESS OTHERWISE SPECIFIED) ±10% ALL VALUES		 BIVAR [®] 4 THOMAS, IRVINE, CA. 92618 TEL: (949) 951-8808 FAX: (949) 951-3974	
ANGULAR X° ± 5°			
		TITLE: STD METAL PANEL MOUNT INDICATORS	
DESIGNED: David Green	DATE: 04/05/05	PART NO: MPR5XX	REVISION: E
CHECKED: T. Yin	DATE: 04/05/05	CAGE CODE : 32559	SHEET # 4 OF 4
CAD GENERATED DOCUMENT, DO NOT MEASURE DRAWING.			