

ITEM	Q'TY	PART NUMBER	PART DESCRIPTION
1	1	PM5R-3	LED Holder, 3-Lead Panel Mount, Press Fit, (5mm)
2	1	5BC-3-XX	T1 ¼ (5mm) 3-Lead Shouldered Bi-color LED, See Page 2.

REV.	DESCRIPTION	DATE	APPROVED
A	Engineering Release	12/02/08	T. Y.
B	Updated LED on Polarity Diagram	09/01/09	T. Y.

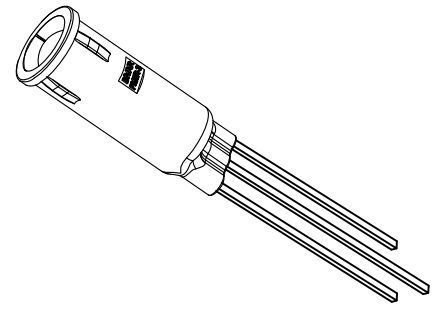
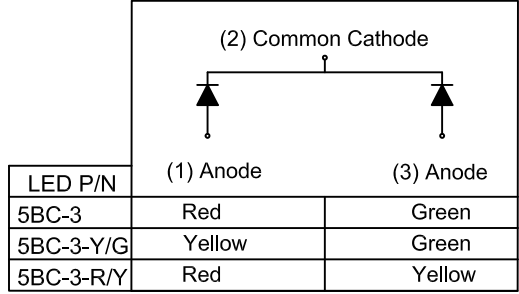
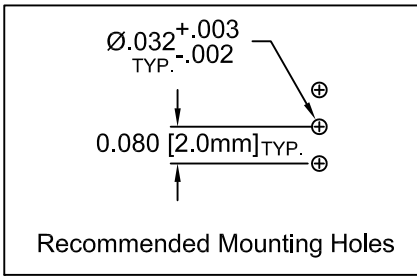
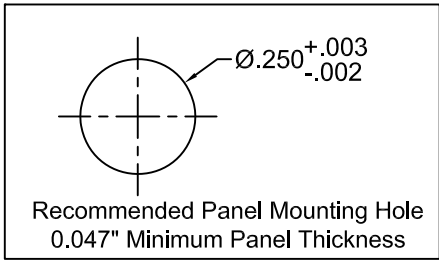
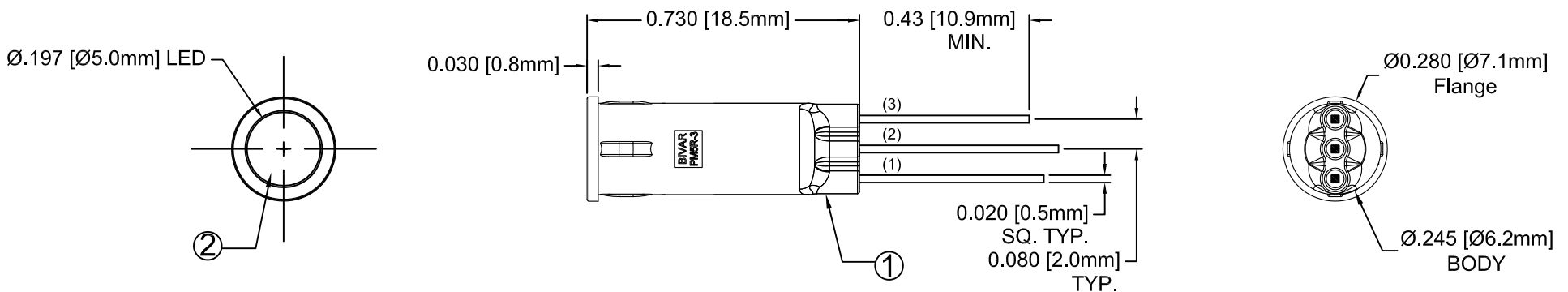

## ABSOLUTE MAXIMUM RATINGS (Ta = 25°C)

- REVERSE VOLTAGE \_\_\_\_\_ 5V
- REVERSE CURRENT ( VR=5V) \_\_\_\_\_ 100µA
- OPERATING TEMPERATURE RANGE \_\_\_\_\_ -25°C ~ 85°C
- STORAGE TEMPERATURE \_\_\_\_\_ -30°C ~ 100°C
- LEAD SOLDERING TEMPERATURE (1/16" FROM BODY) \_\_\_\_\_ 260°C for 5 Seconds

STANDARD TOLERANCE ( UNLESS OTHERWISE SPECIFIED )		<b>BIVAR</b> <sup>®</sup> 4 THOMAS, IRVINE, CA. 92618 TEL: (949) 951-8808 FAX: (949) 951-3974
DECIMALS	ANGULAR	
.X ±.1	X° ± 1°	
.XX ±.02		TITLE: T1 ¼ (5mm) PANEL MOUNT ASSEMBLY, 3-LEAD RECESSED
.XXX ±.010		
DESIGNED: <b>Brian Olliver</b>	DATE: <b>12/02/08</b>	PART NO: <b>PM5R3-XX</b>
CHECKED: <b>F. Jensen</b>	DATE: <b>12/02/08</b>	REVISION: <b>B</b>
CAGE CODE : 32559		SHEET # 1 OF 2
CAD GENERATED DOCUMENT. DO NOT MEASURE DRAWING.		

REV.	DESCRIPTION	DATE	APPROVED
	SEE SHEET#1.		

Assembly Part No.	Emitted Colors	LED Part No.
PM5R3-BC	RED/GREEN	5BC-3
PM5R3-YG	YELLOW/GREEN	5BC-3-Y/G
PM5R3-RY	RED/YELLOW	5BC-3-R/Y

PM5R3 - BC

Emitted Colors

3-Lead Panel Mount Series, Recessed

NOTES:  
1. REFERENCE LED PRINTS FOR OPTICAL/ELECTRICAL SPECIFICATIONS

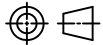
STANDARD TOLERANCE ( UNLESS OTHERWISE SPECIFIED ) ±10% ALL VALUES      ANGULAR		 4 THOMAS, IRVINE, CA. 92618 TEL: (949) 951-8808    FAX: (949) 951-3974	
			<b>TITLE:</b> T-1 $\frac{3}{4}$ (5mm) Panel Mount Assembly
DESIGNED: <b>Brian Oliver</b>	DATE: <b>12/02/08</b>	<b>PART NO:</b> PM5R3-XX	REVISION: <b>B</b>
CHECKED: <b>F. Jensen</b>	DATE: <b>12/02/08</b>	<b>CAGE CODE : 32559</b>	<b>SHEET # 2 OF 2</b>
CAD GENERATED DOCUMENT. DO NOT MEASURE DRAWING.			