

# High Voltage Power Operational Amplifiers

## FEATURES

- ◆ HIGH VOLTAGE — 400V (±200V)
- ◆ LOW QUIESCENT CURRENT — 10mA
- ◆ HIGH OUTPUT CURRENT — 4A
- ◆ PROGRAMMABLE CURRENT LIMIT

## APPLICATIONS

- ◆ PIEZOELECTRIC POSITIONING
- ◆ HIGH VOLTAGE INSTRUMENTATION
- ◆ ELECTROSTATIC TRANSDUCERS
- ◆ PROGRAMMABLE POWER SUPPLIES UP TO 390V

## DESCRIPTION

The PA92 is a high voltage, low quiescent current MOSFET operational amplifier designed as a low cost solution for driving continuous output currents up to 4A and pulse currents up to 7A. The safe operating area (SOA) has no second breakdown limitations and can be observed for all type loads by choosing an appropriate current limiting resistor. The MOSFET output stage is biased AB for linear operation. External compensation provides flexibility in choosing bandwidth and slew rate for the application. Apex Microtechnology's Power SIP package uses a minimum of board space allowing for high density circuit boards. The Power SIP package is electrically isolated.

## EQUIVALENT SCHEMATIC

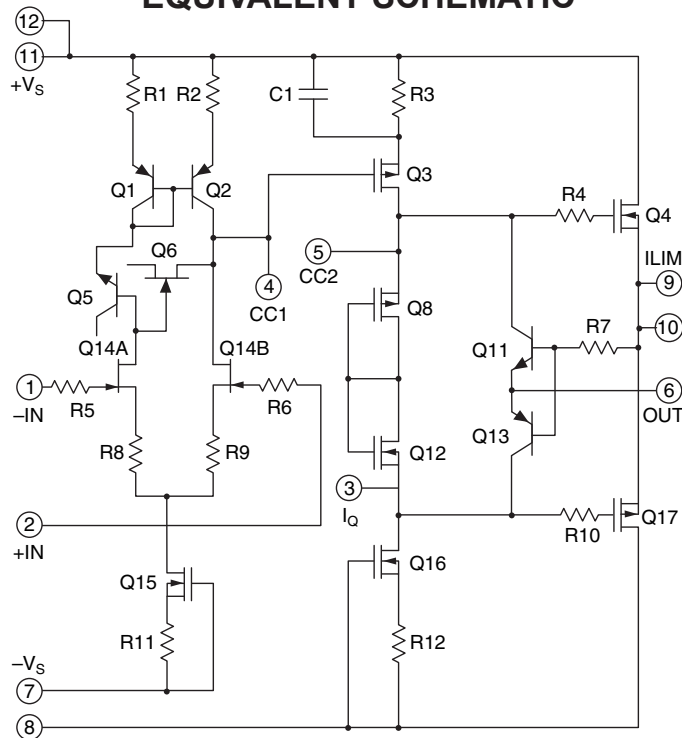

## EXTERNAL CONNECTIONS

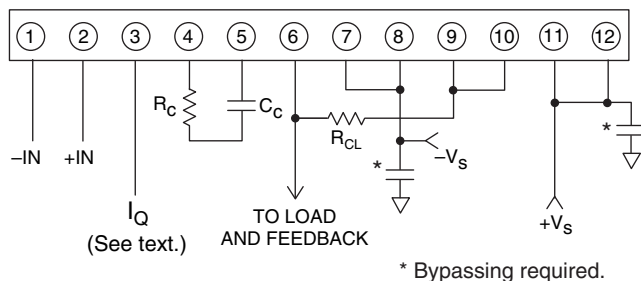

**PATENTED**

**12-pin SIP  
PACKAGE  
STYLE DP**

Formed leads available  
See package style EE



## CHARACTERISTICS AND SPECIFICATIONS

### ABSOLUTE MAXIMUM RATINGS

Parameter	Symbol	Min	Max	Units
SUPPLY VOLTAGE, $+V_s$ to $-V_s$			400	V
OUTPUT CURRENT, source, sink, peak, within SOA			7	A
POWER DISSIPATION, continuous @ $T_c = 25^\circ\text{C}$			80	W
INPUT VOLTAGE, differential		-20	20	V
INPUT VOLTAGE, common mode		$-V_s$	$V_s$	V
TEMPERATURE, pin solder, 10s max.			260	$^\circ\text{C}$
TEMPERATURE, junction (Note 2)			150	$^\circ\text{C}$
TEMPERATURE RANGE, storage		-55	125	$^\circ\text{C}$
OPERATING TEMPERATURE RANGE, case		-40	85	$^\circ\text{C}$

**CAUTION** The PA92 is constructed from MOSFET transistors. ESD handling procedures must be observed. The exposed substrate contains beryllia (BeO). Do not crush, machine, or subject to temperatures in excess of  $850^\circ\text{C}$  to avoid generating toxic fumes.

### SPECIFICATIONS

Parameter	Test Conditions	Min	Typ	Max	Units
<b>INPUT</b>					
OFFSET VOLTAGE, initial			2	10	mV
OFFSET VOLTAGE vs. temperature	Full temperature range		15	50	$\mu\text{V}/^\circ\text{C}$
OFFSET VOLTAGE vs. supply			10	25	$\mu\text{V}/\text{V}$
OFFSET VOLTAGE vs. time			75		$\mu\text{V}/\text{kh}$
BIAS CURRENT, initial			200	2000	pA
BIAS CURRENT vs. supply			4		pA/V
OFFSET CURRENT, initial			50	500	pA
INPUT IMPEDANCE, DC			$10^{11}$		$\Omega$
INPUT CAPACITANCE			4		pF
COMMON MODE VOLTAGE RANGE (Note 3)		$\pm V_s \mp 15$			V
COMMON MODE REJECTION, DC	$V_{\text{CM}} = \pm 90\text{V}$	80	98		dB
NOISE	100KHz bandwidth, $R_s = 1\text{K}\Omega$ , $C_c = 10\text{pF}$		1		$\mu\text{V RMS}$
<b>GAIN</b>					
OPEN LOOP @ 15Hz	$R_L = 2\text{K}\Omega$ , $C_c = 10\text{pF}$	94	111		dB
GAIN BANDWIDTH PRODUCT @ 1MHz	$R_L = 2\text{K}\Omega$ , $C_c = 10\text{pF}$		18		MHz
POWER BANDWIDTH	$R_L = 2\text{K}\Omega$ , $C_c = 10\text{pF}$		30		kHz
PHASE MARGIN	Full temperature range		60		$^\circ$
<b>OUTPUT</b>					
VOLTAGE SWING (Note 3)	$I_o = 4\text{A}$	$\pm V_s \mp 12$	$\pm V_s \mp 10$		V
CURRENT, continuous		4			A
SLEW RATE, $A_v = 100$	$C_c = 10\text{pF}$		50		$\text{V}/\mu\text{S}$
CAPACITIVE LOAD, $A_v = +1$	Full temperature range	1			nF

Parameter	Test Conditions	Min	Typ	Max	Units
SETTLING TIME to 0.1%	$C_c = 10\text{pF}$ , 2V step		1		$\mu\text{S}$
RESISTANCE, no load			10		$\Omega$
<b>POWER SUPPLY</b>					
VOLTAGE (Note 5)		$\pm 50$	$\pm 150$	$\pm 200$	V
CURRENT, quiescent			10	14	mA
<b>THERMAL</b>					
RESISTANCE, AC, junction to case (Note 4)	Full temp range, $F > 60\text{Hz}$			1	$^{\circ}\text{C/W}$
RESISTANCE, DC, junction to case	Full temp range, $F < 60\text{Hz}$			1.5	$^{\circ}\text{C/W}$
RESISTANCE, junction to air	Full temp range		30		$^{\circ}\text{C/W}$
TEMPERATURE RANGE, case	Meets full range specifications	-25		+85	$^{\circ}\text{C}$

- NOTES: 1. (All Min/Max characteristics and specifications are guaranteed over the Specified Operating Conditions. Typical performance characteristics and specifications are derived from measurements taken at typical supply voltages and  $T_c = 25^{\circ}\text{C}$ ).
2. Long term operation at the maximum junction temperature will result in reduced product life. Derate power dissipation to achieve high MTTF.
3.  $+V_s$  and  $-V_s$  denote the positive and negative power supply rail respectively.
4. Rating applies if the output current alternates between both output transistors at a rate faster than 60Hz.
5. Derate max supply rating 0.625 V/ $^{\circ}\text{C}$  below  $25^{\circ}\text{C}$  case. No derating needed above  $25^{\circ}\text{C}$  case.

## TYPICAL PERFORMANCE GRAPHS

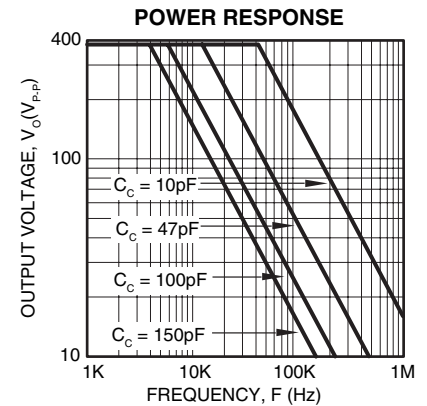
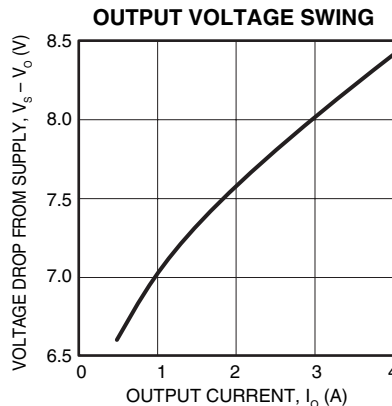
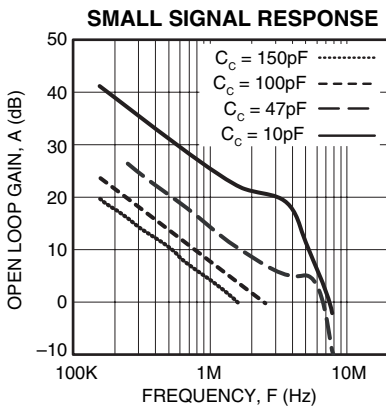
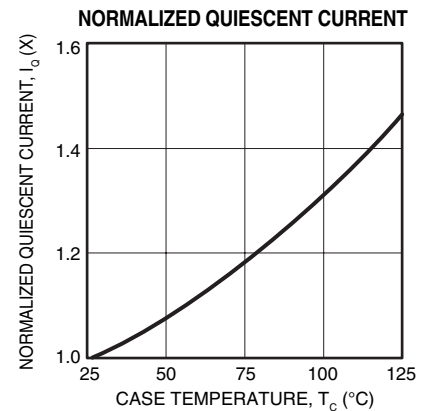
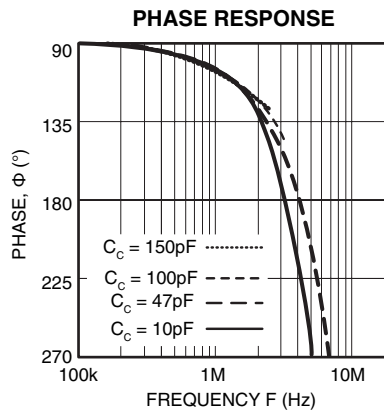
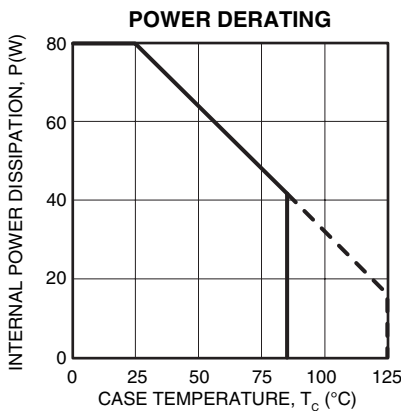

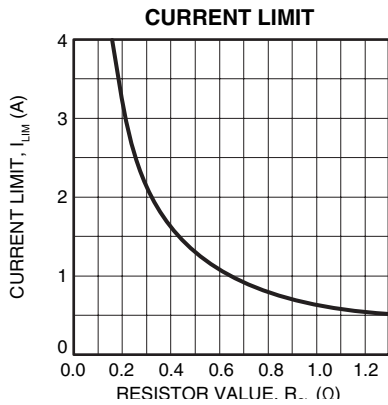
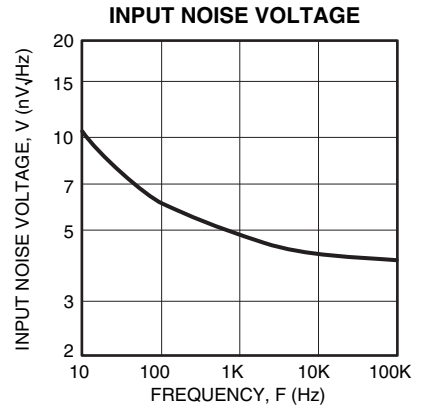
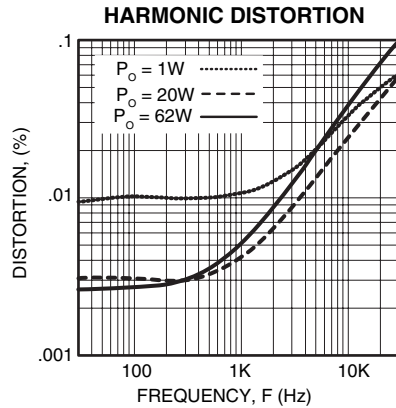
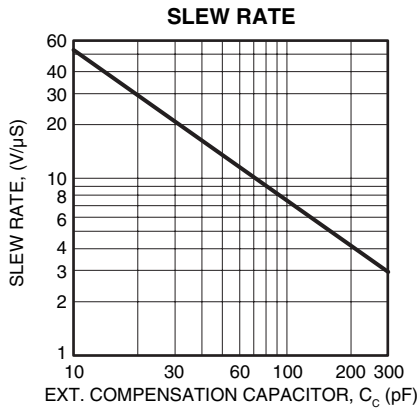

**PHASE COMPENSATION**

GAIN	C <sub>c</sub> * (pF)	R <sub>c</sub> (Ω)
≥1	150	100
≥2	100	100
≥3	47	0
≥12	10	0

\*C<sub>c</sub> Never to be <10pF. C<sub>c</sub> to be rated for the full supply voltage +V to -Vs. Use ceramic NPO (COG) type.

**GENERAL**

Please read Application Note 1 "General Operating Considerations" which covers stability, supplies, heat sinking, mounting, current limit, SOA interpretation, and specification interpretation. Visit [www.apexanalog.com](http://www.apexanalog.com) for design tools that help automate tasks such as calculations for stability, internal power dissipation, current limit; heat sink selection; Apex Microtechnology's complete Application Notes library; Technical Seminar Workbook; and Evaluation Kits.

**CURRENT LIMIT**

For proper operation, the current limit resistor (R<sub>CL</sub>) must be connected as shown in the external connection diagram. For optimum reliability the resistor value should be set as high as possible. The value is calculated as follows; with the maximum practical value of 16 ohms.

$$R_{CL} = \frac{.65}{I_{LIM}}$$

**SAFE OPERATING AREA (SOA)**

The MOSFET output stage of this power operational amplifier has two distinct limitations:

1. The current handling capability of the MOSFET geometry and the wire bonds.
2. The junction temperature of the output MOSFETs.

NOTE: The output stage is protected against transient flyback. However, for protection against sustained, high energy flyback, external fast-recovery diodes should be

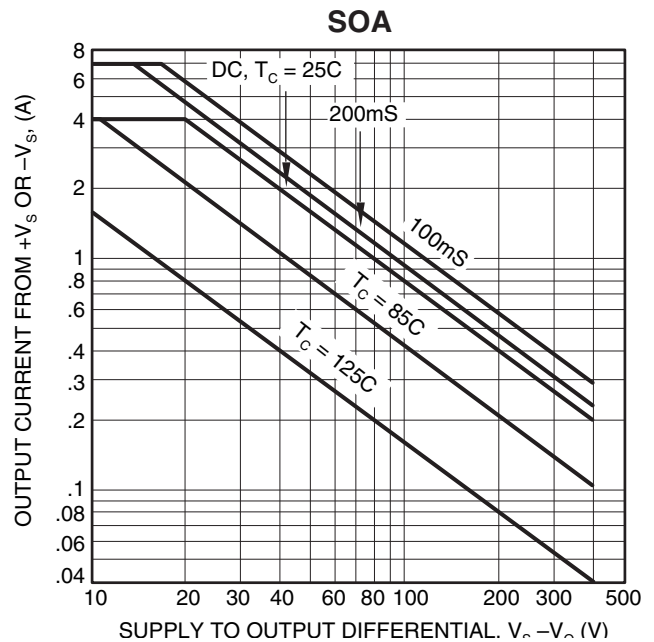

used.

## SAFE OPERATING CURVES

The safe operating area curves define the maximum additional internal power dissipation the amplifier can tolerate when it produces the necessary output to drive an external load.

## INPUT PROTECTION

Although the PA92 can withstand differential voltages up to  $\pm 20V$ , additional external protection is recommended. Low leakage, low capacitance JFETs connected as diodes are recommended (e.g. 2N4416, Q1-Q4 in Figure 2). The differential input voltage will be clamped to  $\pm 1.4V$ . This is sufficient overdrive to produce maximum power bandwidth.

## POWER SUPPLY PROTECTION

Unidirectional zener diode transient suppressors are recommended as protection on the supply pins. See Figure 2. The zeners clamp transients to voltages within the power supply rating and also clamp power supply reversals to ground. Whether the zeners are used or not, the system power supply should be evaluated for transient performance including power-on overshoot and power-off polarity reversals as well as line regulation. Conditions which can cause open circuits or polarity reversals on either power supply rail should be avoided or protected against. Reversals or opens on the negative supply rail is known to induce input stage failure. Unidirectional transzors prevent this, and it is desirable that they be both electrically and physically as close to the amplifier as possible.

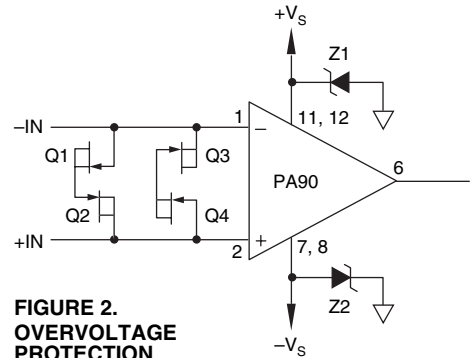

**FIGURE 2.**  
**OVERVOLTAGE PROTECTION**

## STABILITY

The PA92 is externally compensated and performance can be tailored to the application. Use the graphs of small signal response and power response as a guide. The compensation capacitor  $C_c$  must be rated at 500V working voltage. An NPO capacitor is recommended. The compensation network  $C_c R_c$  must be mounted closely to the amplifier pins 4 and 5 to avoid spurious oscillation.

## QUIESCENT CURRENT REDUCTION

When pin 3 ( $I_Q$ ) is shorted to pin 5 (CC2) the AB biasing of the output stage is disabled. This lowers quiescent power but also raises distortion since the output stage is then class C biased. The output stage bias current is nominally set at 1mA. Pin 3 may be left open if not used.

## NEED TECHNICAL HELP? CONTACT APEX SUPPORT!

For all Apex Microtechnology product questions and inquiries, call toll free 800-546-2739 in North America.

For inquiries via email, please contact [apex.support@apexanalog.com](mailto:apex.support@apexanalog.com).

International customers can also request support by contacting their local Apex Microtechnology Sales Representative.

To find the one nearest to you, go to [www.apexanalog.com](http://www.apexanalog.com)

### IMPORTANT NOTICE

Apex Microtechnology, Inc. has made every effort to insure the accuracy of the content contained in this document. However, the information is subject to change without notice and is provided "AS IS" without warranty of any kind (expressed or implied). Apex Microtechnology reserves the right to make changes without further notice to any specifications or products mentioned herein to improve reliability. This document is the property of Apex Microtechnology and by furnishing this information, Apex Microtechnology grants no license, expressed or implied under any patents, mask work rights, copyrights, trademarks, trade secrets or other intellectual property rights. Apex Microtechnology owns the copyrights associated with the information contained herein and gives consent for copies to be made of the information only for use within your organization with respect to Apex Microtechnology integrated circuits or other products of Apex Microtechnology. This consent does not extend to other copying such as copying for general distribution, advertising or promotional purposes, or for creating any work for resale.

APEX MICROTECHNOLOGY PRODUCTS ARE NOT DESIGNED, AUTHORIZED OR WARRANTED TO BE SUITABLE FOR USE IN PRODUCTS USED FOR LIFE SUPPORT, AUTOMOTIVE SAFETY, SECURITY DEVICES, OR OTHER CRITICAL APPLICATIONS. PRODUCTS IN SUCH APPLICATIONS ARE UNDERSTOOD TO BE FULLY AT THE CUSTOMER OR THE CUSTOMER'S RISK.

Apex Microtechnology, Apex and Apex Precision Power are trademarks of Apex Microtechnology, Inc. All other corporate names noted herein may be trademarks of their respective holders.