

CliQ DIN Rail Power Supply

24V 48W 1 Phase / DRP-24V48W1AZ



Highlights & Features

- Universal AC input voltage without power de-rating
- Industrial and ITE safety approvals
- Rugged and compact design (Vibration 5G, Shock 30G)
- Capable of multiple wire connections to terminals
- Wide operating temperature range -20°C to 70°C
- Overvoltage / Overcurrent / Over Temperature / Short Circuit Protections

Safety Standards



CB Certified for worldwide use

Model Number: DRP-24V48W1AZ
Unit Weight: 0.22 kg
Dimensions (L x W x D): 100 x 32 x 100.6 mm

General Description

The DRP-24V48W1AZ has a power rating of 48W with 24V output voltage. Its rugged plastic casing has a compact body at only 32mm wide and operates within a wide temperature range from -20°C to 70°C. Like its CliQ predecessors, the DRP -24V48W1AZ comes with universal AC input and complies with major industrial standards like UL 508 (Safety for Industrial Control Equipment), EMI according to EN 55011 (Industrial, scientific and medical (ISM) radio-frequency equipment) and EMS according to EN 61000-6-2 (Immunity for industrial environments). For broader application compatibility, the product is also certified for ITE (Information Technology Equipment) standard according to IEC/EN/UL 60950-1.

Model Information

CliQ DIN Rail Power Supply

Model Number	Input Voltage Range	Output Voltage	Output Current
DRP-24V48W1AZ	85-264Vac (120-375Vdc)	24Vdc	2.00A

Model Numbering

DR	P –	24V	48W	1	A	Z
DIN Rail	Power Supply	Output Voltage	Output Power	Single Phase	CliQ Series	Plastic Case



CliQ DIN Rail Power Supply

24V 48W 1 Phase / DRP-24V48W1AZ

Specifications

Input Ratings / Characteristics

Nominal Input Voltage	100-240Vac
Input Voltage Range	85-264Vac
Nominal Input Frequency	50-60Hz
Input Frequency Range	47-63Hz
Nominal DC Input Voltage	125-250Vdc
DC Input Voltage Range*	120-375Vdc
Input Current	< 1.40A @ 115Vac, < 0.70A @ 230Vac
Efficiency at 100% Load	> 87.0% @ 115Vac & 230Vac
Max Inrush Current	< 28A @ 115Vac, < 56A @ 230Vac
Leakage Current	< 1mA @ 240Vac

*Fulfills tested conditions

Output Ratings / Characteristics

Nominal Output Voltage	24Vdc
Output Voltage Tolerance	± 1% (initial set point tolerance from factory)
Output Voltage Adjustment Range	22-26Vdc
Output Current	2.00A
Output Power	48W
Line Regulation	< 1% typ. (@ 85-264Vac input, 100% load)
Load Regulation	< 1% typ. (@ 85-264Vac input, 0-100% load)
PARD (20MHz)	< 480mVpp
Rise Time	< 50ms @ nominal input (100% load)
Start-up Time	< 3,000ms @ nominal input (100% load)
Hold-up Time	> 10ms @ 115Vac, > 60ms @ 230Vac (100% load)
Dynamic Response (Overshoot & Undershoot O/P Voltage)	± 5% @ 10-100% load
Start-up with Capacitive Loads	1,000µF Max

Mechanical

Case Cover / Chassis	Plastic
Dimensions (L x W x D)	100 x 32 x 100.6 mm
Unit Weight	0.22 kg
Indicator	Green LED (DC OK)
Cooling System	Convection
Terminal	Input / Output
Wire	5 Pins (Rated 300V/15A)
Mounting Rail	AWG 22-14
Noise (1 Meter from power supply)	Standard TS35 DIN Rail in accordance with EN60715
	Sound Pressure Level (SPL) < 25dBA

CliQ DIN Rail Power Supply

24V 48W 1 Phase / DRP-24V48W1AZ

Environment

Surrounding Air Temperature	Operating	-20°C to +70°C
	Storage	-25°C to +85°C
Power De-rating	Vertical / Horizontal Mounting	-20°C to -10°C de -rate power by 1% / °C, -10°C to 0°C de -rate power by 2% / °C, > 50°C de -rate power by 2.5% / °C
Operating Humidity		< 95% RH (Non-Condensing)
Operating Altitude		2,000 Meters
Shock Test (Non-Operating)		IEC60068-2-27, 30G (300m/S for a duration of 18ms, 1 times per direction, 2 times in total)
Vibration (Non-Operating)		IEC60068-2-6, 10Hz to 150Hz @ 50m/S ² (5G peak); 90 min per axis for all X, Y, Z direction
Pollution Degree		2

Protections

Overvoltage	< 32.4V, SELV Output, Latch-off Mode
Overload / Overcurrent	> 105~180% of rated load current, Hicc-up Mode, Non-Latching (Auto-Recovery)
Over Temperature	< 75°C Surrounding Air Temperature @ 100% load, Latch-off Mode
Short Circuit	Hicc-up Mode, Non-Latching (Auto-Recovery when the fault is removed)
Protection Against Shock	Class I with PE* connection

*PE: Primary Earth

Reliability Data

MTBF	> 500,000 hrs. as per Telcordia SR-332
Expected Cap Life Time	10 years (115Vac & 230Vac, 50% load @ 40°C)

CliQ DIN Rail Power Supply

24V 48W 1 Phase / DRP-24V48W1AZ

Safety Standards / Directives

Electrical Equipment in Power Installations	EN 50178 / IEC 62103	
Electrical Safety	SIQ to EN 60950-1, UL/cUL recognized to UL 60950-1 and CSA C22.2 No. 60950-1, CB scheme to IEC 60950-1	
Industrial Control Equipment	UL/cUL listed to UL 508 and CSA C22.2 No. 107.1-01, CSA to CSA C22.2 No. 107.1-01 (File No. 181564)	
CE	In conformance with EMC Directive 2004/108/EC and Low Voltage Directive 2006/95/EC	
Material and Parts	RoHS Directive 2011/65/EU Compliant	
Galvanic Isolation	Input to Output	3.0KVac
	Input to Ground	1.5KVac
	Output to Ground	0.5KVac

EMC

EMC / Emissions	CISPR22, EN 55022, FCC Title 47: Class B CISPR11, EN 55011 Class B	
Immunity to	EN 55024, EN 61000-6-2	
Electrostatic Discharge	IEC 61000-4-2	Level 3 Criteria A ¹⁾ Air Discharge: 8kV Contact Discharge: 6kV
Radiated Field	IEC 61000-4-3	Level 3 Criteria A ¹⁾ 80MHz-1GHz, 10V/M, 80% modulation (1KHz) 1.4GHz-2GHz, 3V/M, 80% modulation (1KHz) 2GHz-2.7GHz, 1V/M, 80% modulation (1KHz)
Electrical Fast Transient / Burst	IEC 61000-4-4	Level 3 Criteria A ¹⁾ 2kV
Surge	IEC 61000-4-5	Level 3 Criteria A ¹⁾ Common Mode ²⁾ : 2kV Differential Mode ³⁾ : 1kV
Conducted	IEC 61000-4-6	Level 3 Criteria A ¹⁾ 150kHz-80MHz, 10Vrms
Power Frequency Magnetic Fields	IEC 61000-4-8	Criteria A ¹⁾ 30A/Meter
Voltage Dips	IEC 61000-4-11	100% dip; 1 cycle (20ms); Self Recoverable
Low Energy Pulse Test (Ring Wave)	IEC 61000-4-12	Level 3 Criteria A ¹⁾ Common Mode ²⁾ : 2kV Differential Mode ³⁾ : 1kV
Voltage Fluctuation and Flicker	IEC/EN 61000-3-3	

1) Criteria A: Normal performance within the specification limits

2) Asymmetrical: Common mode (Line to earth)

3) Symmetrical: Differential mode (Line to line)

CliQ DIN Rail Power Supply

24V 48W 1 Phase / DRP-24V48W1AZ

Block Diagram

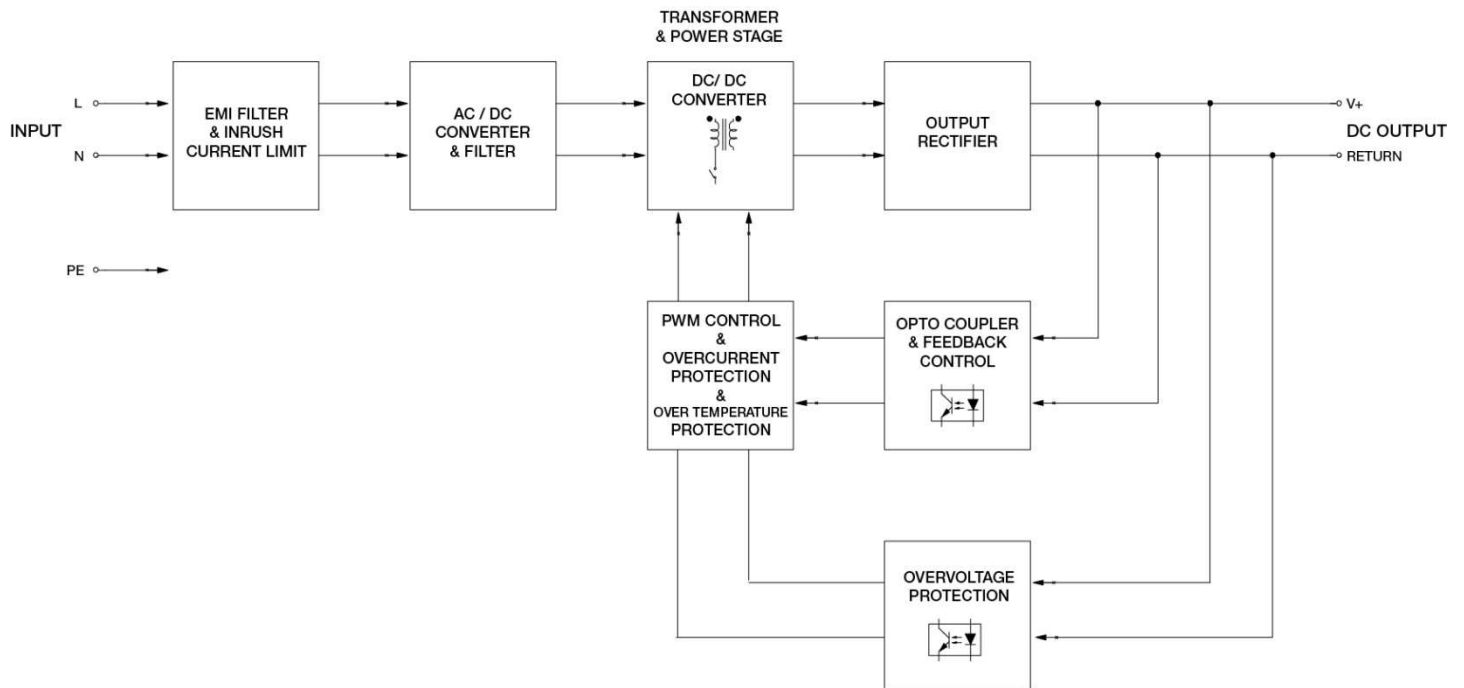

Device Description

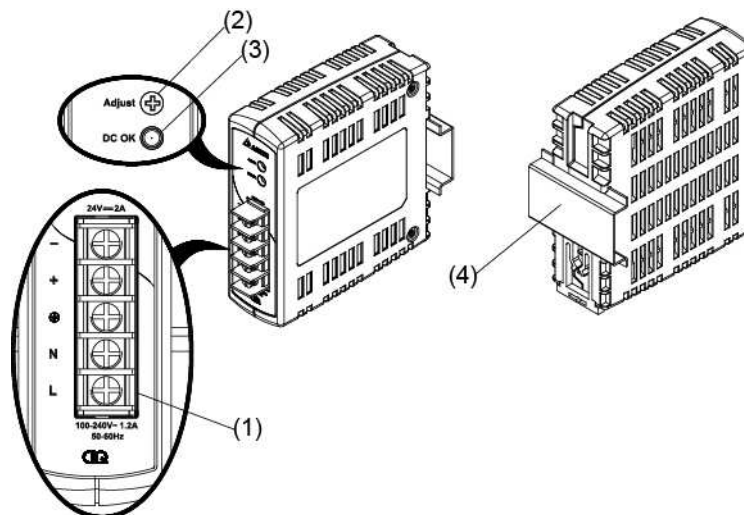

- 1) Input & Output terminal block connector
- 2) DC Voltage adjustment potentiometer
- 3) DC OK control LED (Green)
- 4) Universal mounting rail system

CliQ DIN Rail Power Supply

24V 48W 1 Phase / DRP-24V48W1AZ

Dimensions

L x W x D: 100 x 32 x 100.6 mm

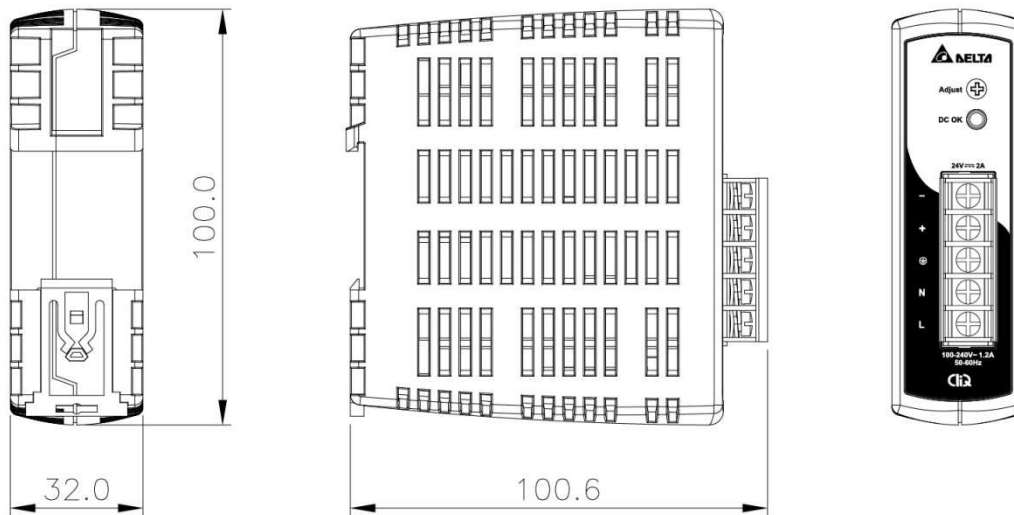

Engineering Data

De-rating

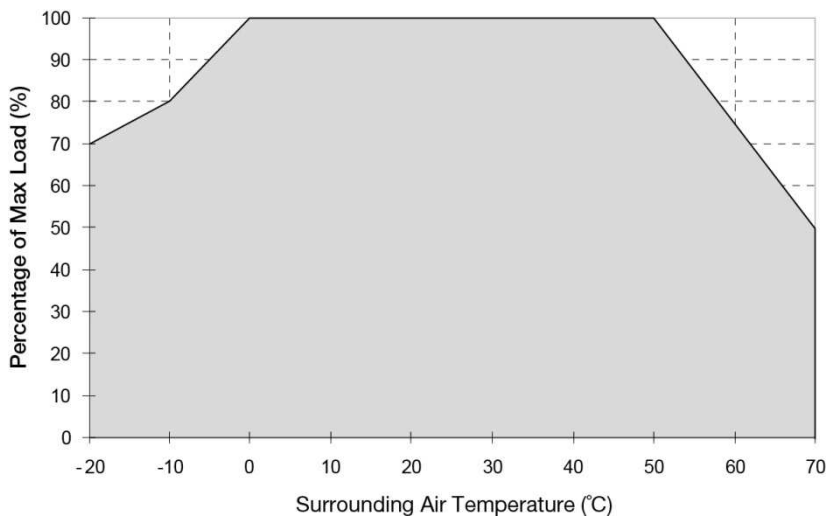

Fig. 1 De-rating for Vertical and Horizontal Mounting Orientation
 -20°C to -10°C de-rate power by 1% / °C,
 -10°C to 0°C de-rate power by 2% / °C,
 > 50°C de-rate power by 2.5% / °C

Note

1. Power supply components may degrade, or be damaged, when the power supply is continuously used outside the shaded region, refer to the graph shown in Fig. 1.
2. If the output capacity is not reduced when the surrounding air temperature > 50°C, the device may run into Over Temperature Protection. When activated, the output voltage will go into latch-off mode until the component temperature cools down and the AC power is recycled.
3. In order for the device to function in the manner intended, it is also necessary to keep a safety distance of 20mm (for Vertical Mounting) or 50mm (for Horizontal Mounting) with adjacent units while the device is in operation.
4. Depending on the surrounding air temperature and output load delivered by the power supply, the device can be very hot!
5. If the device has to be mounted in any other orientation, please do not hesitate to contact info@deltapsu.com for more details.

CliQ DIN Rail Power Supply

24V 48W 1 Phase / DRP-24V48W1AZ

Output De-rating VS. Input Voltage

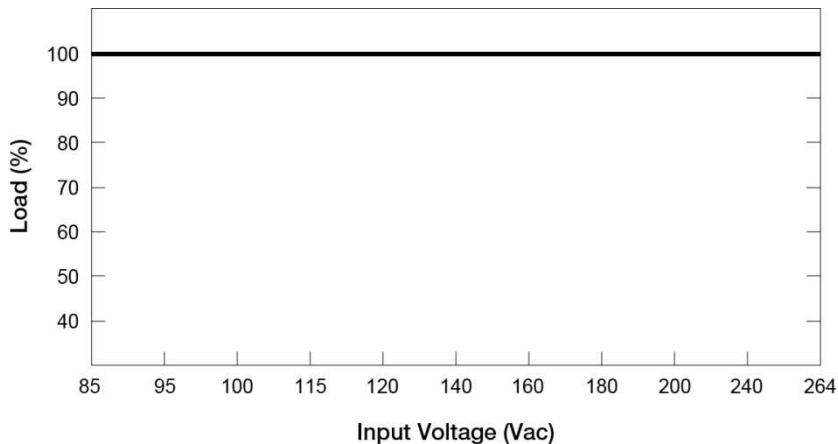

- No output power de-rating across the entire input voltage range

Assembly & Installation

The power supply unit (PSU) can be mounted on 35mm DIN rails in accordance with EN60715. For Vertical Mounting, the device should be installed with input terminal block at the bottom. For Horizontal Mounting, the device should be installed with input terminal block on the left side.

Each device is delivered ready to install.

Mounting

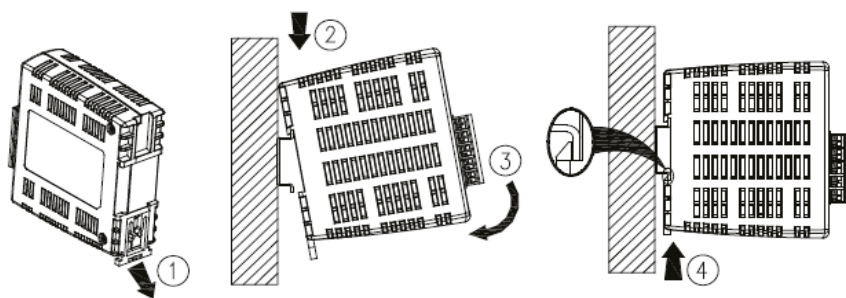

Snap on the DIN rail as shown on the left:

1. Pull the unit's DIN rail latch OUT.
2. Tilt the unit slightly upwards, hook the top end onto the DIN rail and push downwards until stopped.
3. Position the bottom front end against the DIN rail.
4. Push the unit's latch DIN rail IN to lock.

Dismounting

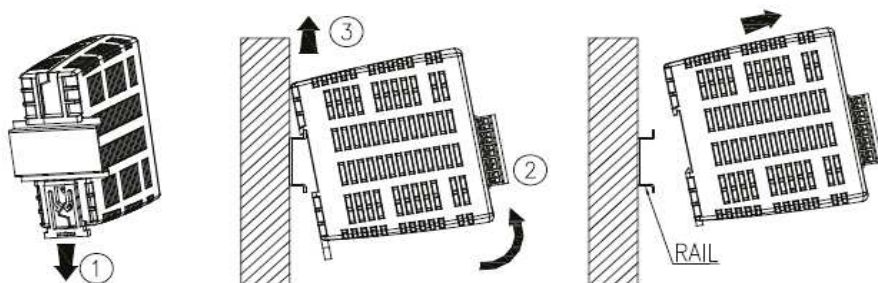

To uninstall:

1. Pull the unit's DIN rail latch OUT.
2. Tilt the bottom part of the unit out.
3. Push the unit up and pull out from the DIN rail.

CliQ DIN Rail Power Supply

24V 48W 1 Phase / DRP-24V48W1AZ

Safety Instructions

■ Vertical Mounting

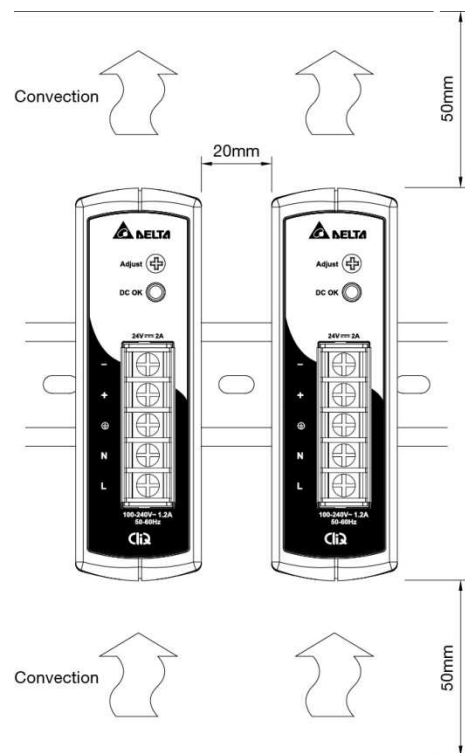

■ Horizontal Mounting

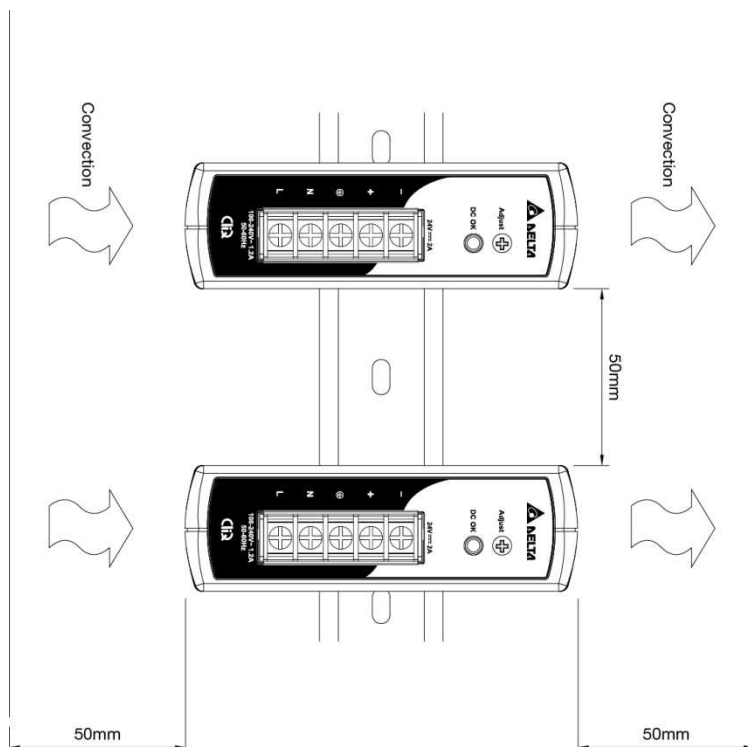

- ALWAYS switch mains of input power OFF before connecting and disconnecting the input voltage to the unit. If mains are not turned OFF, there is risk of explosion / severe damage.
- **To guarantee sufficient convection cooling, keep a distance of 50mm above and below the device as well as a lateral distance of 20mm (for Vertical Mounting) or 50mm (for Horizontal Mounting) to other units.**
- Note that the enclosure of the device can become very hot depending on the surrounding air temperature and load of the power supply. Risk of burns!
- The main power must be turned off before connecting or disconnecting wires to the terminals!
- DO NOT insert any objects into the unit.
- Hazardous voltages may be present for up to 5 minutes after the input mains voltage is disconnected. Do not touch the unit during this time.
- The power supplies unit should be installed in minimum IP54 rated enclosure.
- The power supplies are built in units and must be installed in a cabinet or room (condensation free environment and indoor location) that is relatively free of conductive contaminants.

CliQ DIN Rail Power Supply

24V 48W 1 Phase / DRP-24V48W1AZ

Functions

■ Graph illustrating the Start-up Time, Rise Time, and Hold-up Time

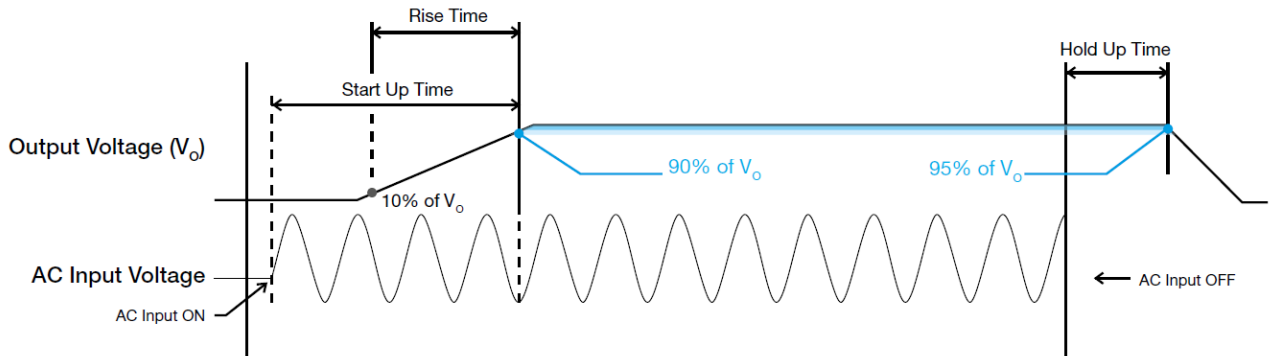

Start-up Time

The time required for the output voltage to reach 90% of its set value, after the input voltage is applied.

Rise Time

The time required for the output voltage to change from 10% to 90% of its set value.

Hold-up Time

Hold up time is the time when the AC input collapses and output voltage retains regulation for a certain period of time. The time required for the output to reach 90% of its set value, after the input voltage is removed.

CliQ DIN Rail Power Supply

24V 48W 1 Phase / DRP-24V48W1AZ

Inrush Current

Inrush current is the peak, instantaneous, input current measured and, occurs when the input voltage is first applied. For AC input voltages, the maximum peak value of inrush current will occur during the first half cycle of the applied AC voltage. This peak value decreases exponentially during subsequent cycles of AC voltage.

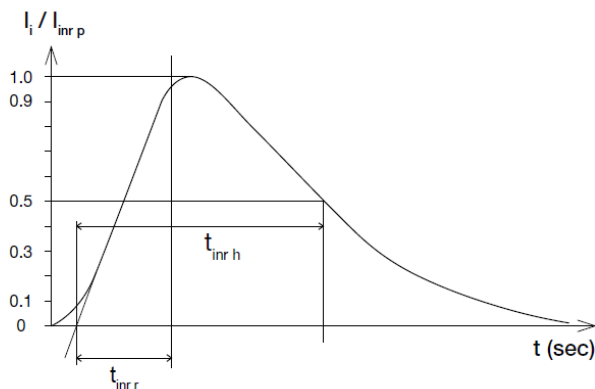

Overvoltage Protection

The power supply's overvoltage circuit will be activated when its internal feedback circuit fails. The output voltage shall not exceed its specifications defined on Page 3 under "Protections".

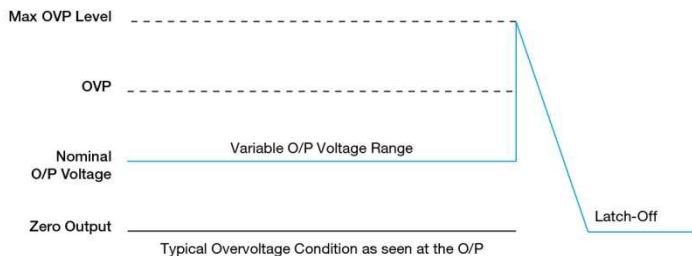

Over Temperature Protection

As mentioned, the power supply also has Over Temperature Protection (OTP). This is activated when the overload condition persists for an extended duration and the output current is below the overload trigger point but >100% load. In the event of a higher operating condition at 100% load, the power supply will run into OTP when the surrounding air temperature is >75°C. When activated, the output voltage will go into latch-off mode until the component temperature cools down and the AC power is recycled.

Dynamic Response

The power supply output voltage will remain within ±5% of its steady state value, when subjected to a dynamic load from 10% to 100% of its rated current.

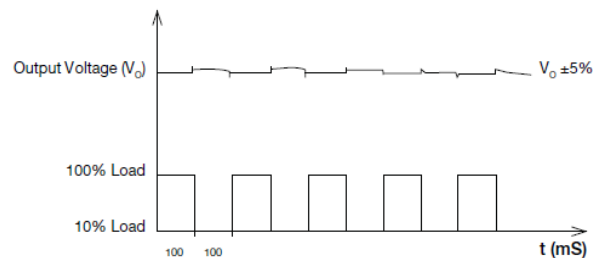

Overload & Overcurrent Protections

The power supply's Overload (OLP) and Overcurrent (OCP) Protections will be activated when output current exceeds 105~180% of I_O (Max load). In such occurrence, the V_O will start to droop and once the power supply has reached its maximum power limit, the protection is activated and the power supply will go into "Hiccup mode" (Auto-Recovery). The power supply will recover once the fault condition of the OLP and OCP is removed and I_O is back within the specifications.

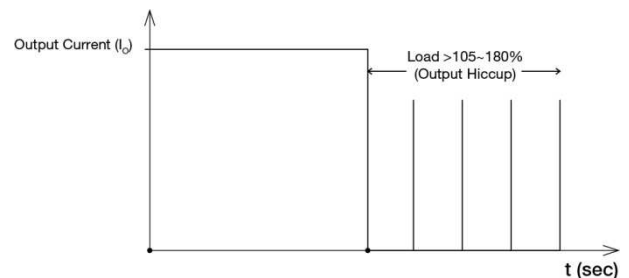

Additionally, if the I_O is <105-180% but >100% for a prolonged period of time (depending on the load), the Over Temperature Protection (OTP) will be activated due to high temperature on critical components. The power supply will then go into "Latch-off mode" until the PSU cools down and the AC power is recycled.

Short Circuit Protection

The power supply's output OLP/OCP function also provides protection against short circuits. When a short circuit is applied, the output current will operate in "Hiccup mode", as shown in the illustration in the OLP/OCP section on this page. The power supply will return to normal operation after the short circuit is removed.

CliQ DIN Rail Power Supply

24V 48W 1 Phase / DRP-24V48W1AZ

Operating Mode

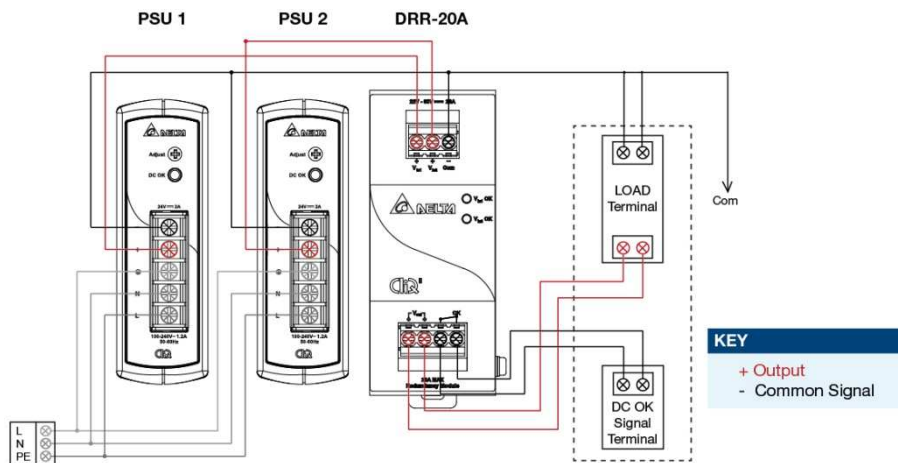

Fig. 2 Redundancy / Parallel Operation Connection Diagram

Parallel Operation

These DRR modules can also be used for Parallel function in order to increase the output power by N+1 (e.g. 2.5A + 2.5A = 5A or 2.5A + 2.5A + 2.5A = 7.5A) or current sharing, and thus increasing the power supply and system reliability. Though the DRP-24V48W1AZ is not designed for current sharing, a good current sharing between two power supplies can be achieved by following simple steps as below (Refer to Fig. 2 for the Connection Diagram).

Step 1.

Set output load condition for both supplies at 50% and measure the output voltages.

Step 2.

Adjust output voltages to the same level or within $\pm 25\text{mV}$ difference.

Step 3.

Connect PSU 1 and PSU 2 with the DRR-20A module and measure at $V_{in 1}$ & $V_{in 2}$ to verify the voltage difference. Ensure the voltages are within $\pm 25\text{mV}$.

Step 4.

Output voltage from DRR module V_{out} will be = V_O (output voltage of power supply) - V_{drop}^* (in DRR module).

* V_{drop} will vary from 0.60V to 0.90V (Typical 0.65V) depending on the load current and surrounding air temperature.

Redundancy Operation

In order to ensure proper redundancy operation for the power supply unit (PSU), ensure that the output voltage difference between the two units is kept at 0.45~0.50V for 24V supplies. Follow simple steps given below to verify:

Step 1.

Measure output voltage of PSU 1 and PSU 2. If PSU 1 is the master unit, then V_O of PSU 1 must be higher than PSU 2.

In order to set the output voltage, connect the power supply to 50% load and set the PSU 1 and PSU 2 output voltage.

Step 2.

Connect the right DRR module, 20A as per the system requirement to the power supply units PSU 1 and PSU 2 at $V_{in 1}$ & $V_{in 2}$ respectively.

Step 3.

Connect the system load from V_{out} . Please note that output voltage V_{out} from DRR module will be = V_O (output voltage of power supply) - V_{drop}^* (in DRR module).

CliQ DIN Rail Power Supply

24V 48W 1 Phase / DRP-24V48W1AZ

Others

Delta RoHS Compliant



Restriction of the usage of hazardous substances

The European directive 2011/65/EU limits the maximum impurity level of homogeneous materials such as lead, mercury, cadmium, chrome, polybrominated flame retardants PBB and PBDE for the use in electrical and electronic equipment. RoHS is the abbreviation for "Restriction of the use of certain hazardous substances in electrical and electronic equipment".

This product conforms to this standard.