

NOTES: UNLESS OTHERWISE SPECIFIED

1.

NOTICE:	THIS IS A RoHS COMPLIANT COMPONENT/PRODUCT. ALL ENGINEERING CHANGES MUST HAVE PRIOR APPROVAL BY THE DESIGN CENTER.
RoHS	

- 2. PLASTIC: THERMOSET PLASTIC MATERIAL WITH FLAMMABILITY RATING UL 94V-0 OR BETTER.
- 3. SOLDERABILITY: CONFORMS TO ANSI/J-STD-002, 245°C REFLOW PEAK TEMPERATURE PER IPC/EIA J-STD-003A
- 4. OPERATING TEMPERATURE: 0°C TO +70°C
- 5. STORAGE TEMPERATURE: -20°C TO +125°C
- 6. JEDEC MOISTURE: LEVEL 1.
- 7. DIMENSIONS ARE IN INCHES WITH THE FOLLOWING TOLERANCES:
.XX = ±.02
.XXX = ±.010
- 8. REVISION: MX1, MX2, ARE PRELIMINARY.

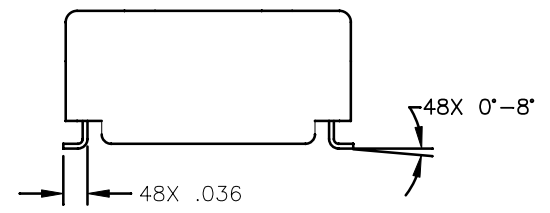
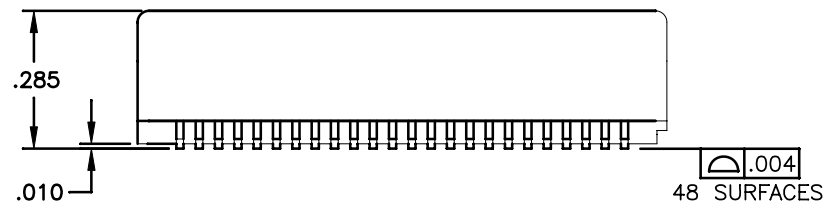
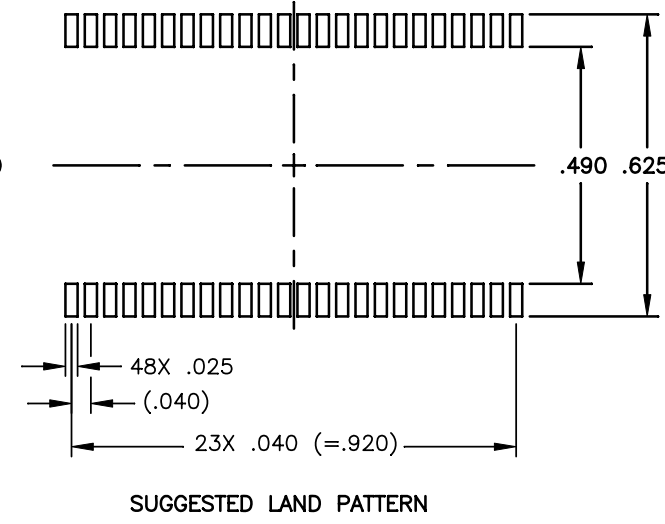
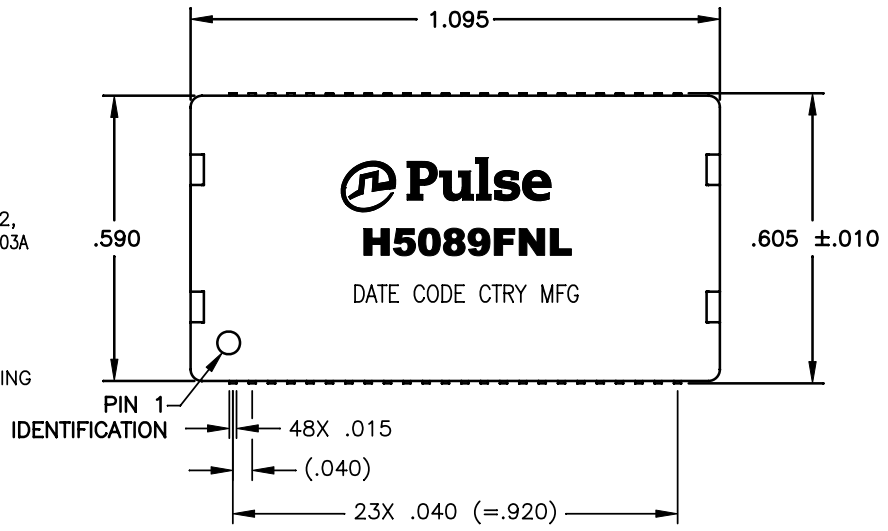

© Copyright, 2013. Pulse Electronics Corp. All rights reserved. Drawing specifications subject to change without notice. (08/08/13)

PULSE CONFIDENTIAL & PROPRIETARY	PRODUCT DESCRIPTION	PS DRAWING	SHEET:	DWG. NO./ PART NO.	REV.
	MDL,SIN,1GD,1:1,SM,TU	PS-2747.001-A	1	H5089FNL	MP1

ELECTRICAL CHARACTERISTICS AT +25°C

PARAMETER	SPECIFICATIONS	
OPERATING TEMP	0°C - 70 °C	
TURNS RATIO	1.00 ± 2%	
POLARITY	PER SCHEMATIC	
INSERTION LOSS	100 KHz	1-125 MHz
	-1.2 dB MAX	-0.2-0.002*f ^{1.4} dB MAX
RETURN LOSS (Z OUT = 100 OHM ±15%)	.1-40 MHz	40-100 MHz
	-16 dB MIN	-10+20*LOG ₁₀ (f/80 MHz) dB MIN
INDUCTANCE (OCL) (MEDIA SIDE, 0°C-70°C)	350 uH MIN (MEASURED AT 100 KHz, 100 mVRMS AND WITH 8 mA DC BIAS)	
CROSSTALK, ADJACENT CHANNELS	1 MHz	10-100 MHz
	-50 dB MIN	-55+22*LOG ₁₀ (f/10) dB MIN
COMMON MODE REJECTION RATIO	2 MHz	30-200 MHz
	-50 dB MIN	-15+20*LOG ₁₀ (f/200) dB MIN
INPUT - OUTPUT ISOLATION	1500 VRMS MIN @ 60 SECONDS	

NOTE: f IS FREQUENCY IN MHz.

LEGEND

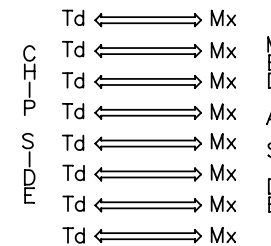

ALL CHANNELS ARE
IN PHASE BETWEEN
INPUT AND OUTPUT

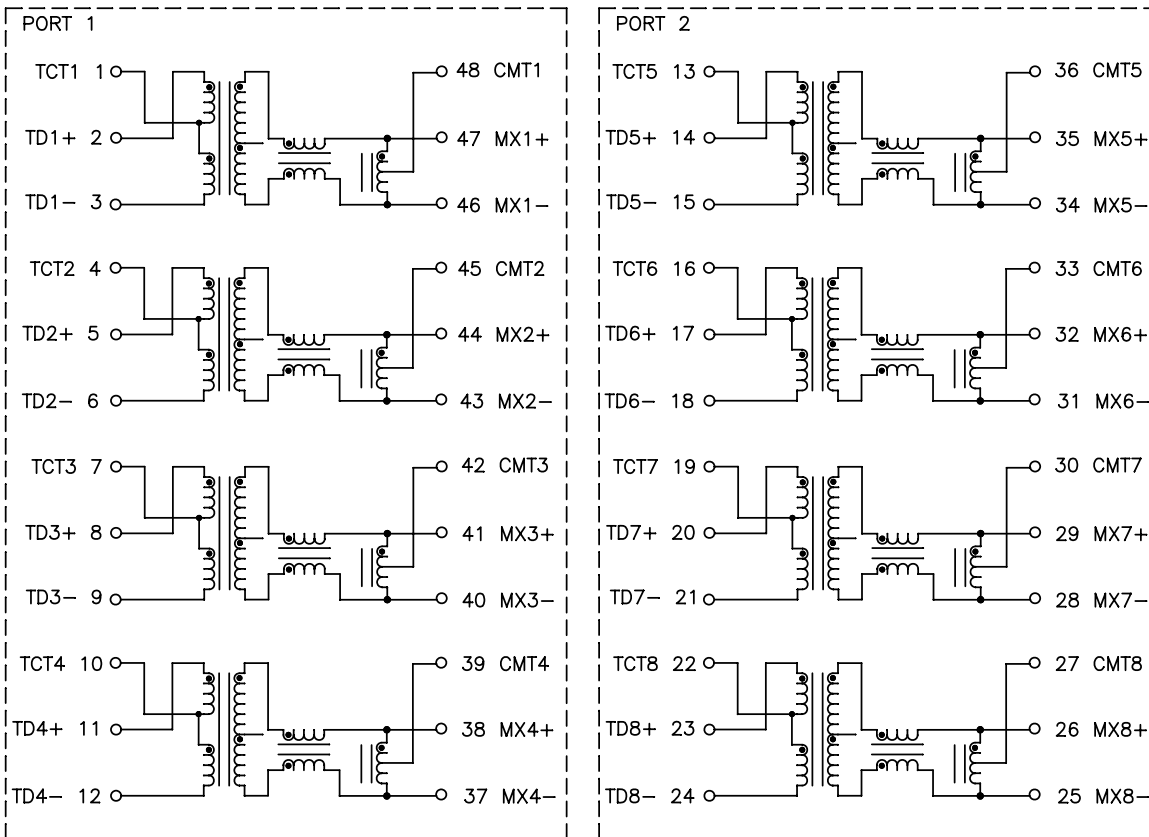

SCHEMATIC

PULSE CONFIDENTIAL & PROPRIETARY	PRODUCT DESCRIPTION	PS DRAWING	SHEET:	DWG. NO./ PART NO.	REV.
	MDL,SIN,1GD,1:1,SM,TU	PS-2747.001-A	2	H5089FNL	MP1