

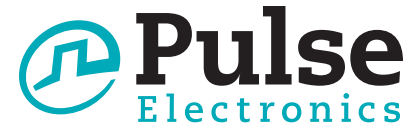





SMT Power Inductors

Military/Aerospace Grade

Wire Wound



-  **Ruggedized for the Military and Aerospace Industries**
-  **Height: 0.480" MAX**
-  **Footprint: 0.75" x 0.875"**
-  **Maximum Reflow Temperature: 235°C**
-  **MSL: 1**

Electrical Specifications @ 25°C - Operating Temperature -55°C to +125°C

Part Number ⁶	Inductance @0Adc (μH ±10%)	Inductance @ Irated (μH TYP)	Irated ¹ (Adc)	DCR (mΩ±10%)	Saturation ² Current Isat (A TYP)		Heating ³ Current Ibc (A TYP)	Core Loss Factor K2
					25°C	100°C		
PL2089	16.0	16.0	9.9	9.1	12	11	9.9	258
PL2131	41.00	40.00	6.0	23.10	7.3	6.0	6.2	413
PL2141	57.8	57.8	5.0	34.5	6.2	5	5.1	490

Notes

- The rated current as listed is either the saturation current or the heating current depending on which value is lower.
- The saturation current is the typical current which causes the inductance to drop by 20% at the stated ambient temperatures (25°C and 100°C). This current is determined by placing the component in the specified ambient environment and applying a short duration pulse current (to eliminate self-heating effects) to the component.
- The heating current is the DC current which causes the part temperature to increase by approximately 40°C.
- In high volt*time applications, additional heating in the component can occur due

to core losses in the inductor which may necessitate derating the current in order to limit the temperature rise of the component. To determine the approximate total losses (or temperature rise) for a given application, the coreloss and temperature rise formula can be used:

$$\Delta B \text{ (Gauss)} = K2 * \Delta I$$

$$\text{Core Loss (W)} = 1.5E-13 * (\text{Freq_kHz})^{1.63} * \Delta B^{2.62}$$

- The temperature of the component (ambient plus temperature rise) must be within the stated operating temperature range.
- RoHS compliant version (100% pure Sn leads) available. Add suffix NL to the part number.

Mechanicals

Schematics

PL2085/PL2131/PL2141

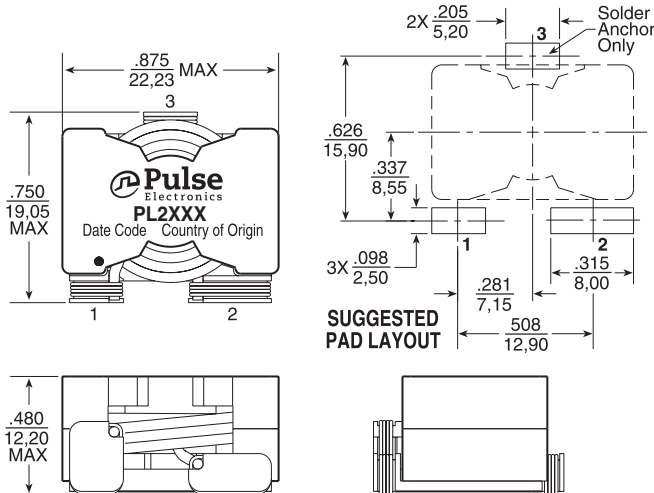

Lead Finish Sn63/Pb37
 Weight 13 grams
 PAN 70/tray
 Dimensions: $\frac{\text{Inches}}{\text{mm}}$

Unless otherwise specified, all tolerances are $\pm \frac{.010}{0,25}$

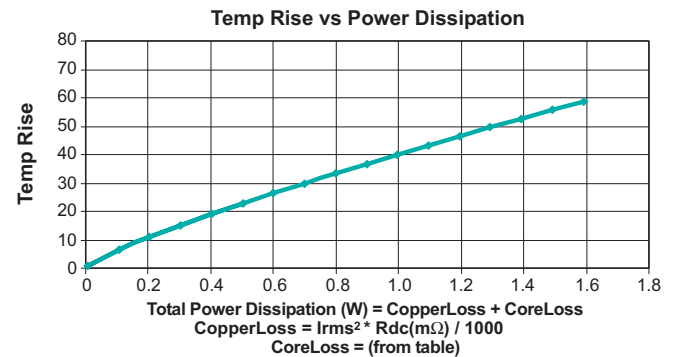
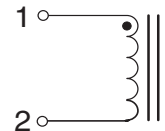

USA 215 781 6400

Germany 49 7032 7806 0

Singapore 65 6287 8998

Shanghai 86 21 62787060

China 86 755 33966678

Taiwan 886 3 4356768

Inductance vs Current Characteristics

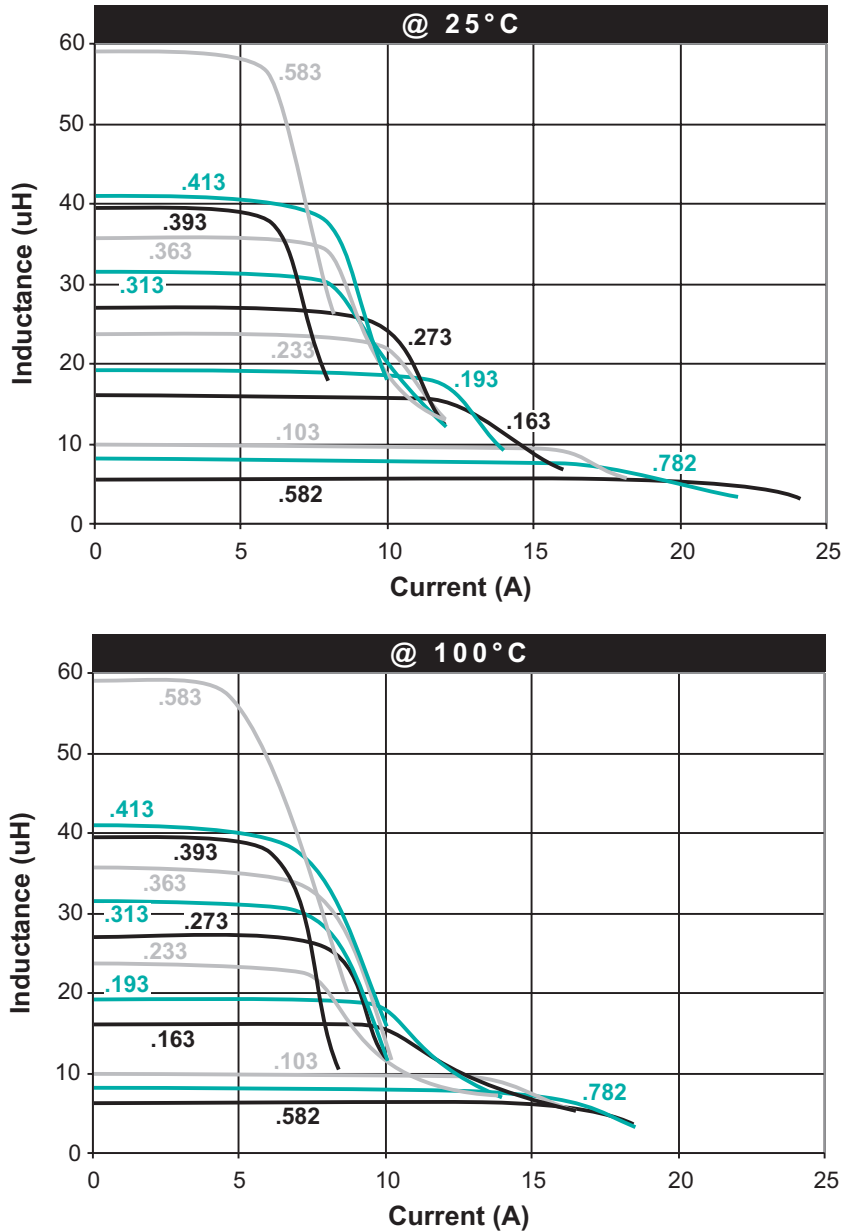

For More Information

Pulse Worldwide Headquarters
Two Pearl Buck Court
Bristol, PA 19007
U.S.A.

Pulse Europe
Zeppelinstrasse 15
71083 Herrenberg
Germany

Pulse China Headquarters
B402, Shenzhen Academy of
Aerospace Technology Bldg.
10th Kejian Road
High-Tech Zone
Nanshan District
Shenzhen, PR China 518057
Tel: 86 755 33966678
Fax: 86 755 33966700

Pulse North China
Room 2704/2705
Super Ocean Finance Ctr.
2067 Yan An Road West
Shanghai 200336
China

Pulse South Asia
135 Joo Seng Road
#03-02
PM Industrial Bldg.
Singapore 368363

Pulse North Asia
3F No. 198, Zhongyuan Road
Zhongli City
Taoyuan County (32068)
Taiwan

Tel: 215 781 6400
Fax: 215 781 6403

Tel: 49 7032 7806 0
Fax: 49 7032 7806 12

Tel: 86 21 62787060
Fax: 86 2162786973

Tel: 65 6287 8998
Fax: 65 6287 8998

Tel: 886 3 4356768
Fax: 886 3 4356823

Performance warranty of products offered on this data sheet is limited to the parameters specified. Data is subject to change without notice. Other brand and product names mentioned herein may be trademarks or registered trademarks of their respective owners. © Copyright, 2012. Pulse Electronics, Inc. All rights reserved.