





SMT POWER INDUCTORS

Shielded Drum Core - PL89XX Series



-  **Height:** 7.1mm Max
-  **Footprint:** 10.5mm x 10.5mm Max
-  **Inductance Range:** 0.8 μ H to 54.4 μ H
-  **Current Rating:** up to 11A

Electrical Specifications @ 25°C — Operating Temperature -55°C to +130°C

Part Numbers	Inductance @Irated (μ H TYP)	Irated ² (A)	DCR (m Ω)		Inductance @0A _{DC} (μ H)	Saturation Current ³ (A) @25°C	Heating Current ⁴ (A)
			TYP	MAX			
PL8901	0.80	11	3.5	4.0	1.0*	14	11
PL8902	1.20	10	4.3	6.0	1.5*	13	10
PL8903	2.1	9.0	5.1	7.3	2.7*	11	9
PL8904	2.9	8.0	6.9	8.5	3.7*	9.2	8
PL8905	3.7	7.3	7.9	9.5	4.7*	8.2	7.3
PL8906	4.8	6.0	10.9	16.5	6.0*	6.9	6.0
PL8907	6	5.5	14.8	18.5	7.6*	6.2	5.5
PL8908	8	5.0	16.7	21.8	10	5.5	5.0
PL8909	9.6	4.5	18.1	29.0	12	5.1	4.5
PL8910	12	4.1	21.2	35.4	15	4.4	4.1
PL8911	14.4	4.0	27.9	37.0	18	4.3	4.0
PL8912	17.6	3.8	29.8	42.0	22	3.8	3.8
PL8913	21.6	3.4	40.9	45.9	27	3.4	3.4
PL8914	26.4	3.0	43.1	64.8	33	3.0	3.1
PL8915	31.2	2.7	60.8	81.5	39	2.8	2.7
PL8916	37.6	2.6	67.1	89.0	47	2.6	2.6
PL8917	54.4	2.1	103.6	135.0	68	2.1	2.1

*Inductance at 0A_{DC} tolerance on indicated part numbers is $\pm 30\%$; tolerance is $\pm 20\%$ on all other parts. Optional Tape & Reel packaging can be ordered by adding a "T" suffix to the part number (i.e. PL8901 becomes PL8901T). **NOTES FROM TABLE:** (See back page)

Mechanical

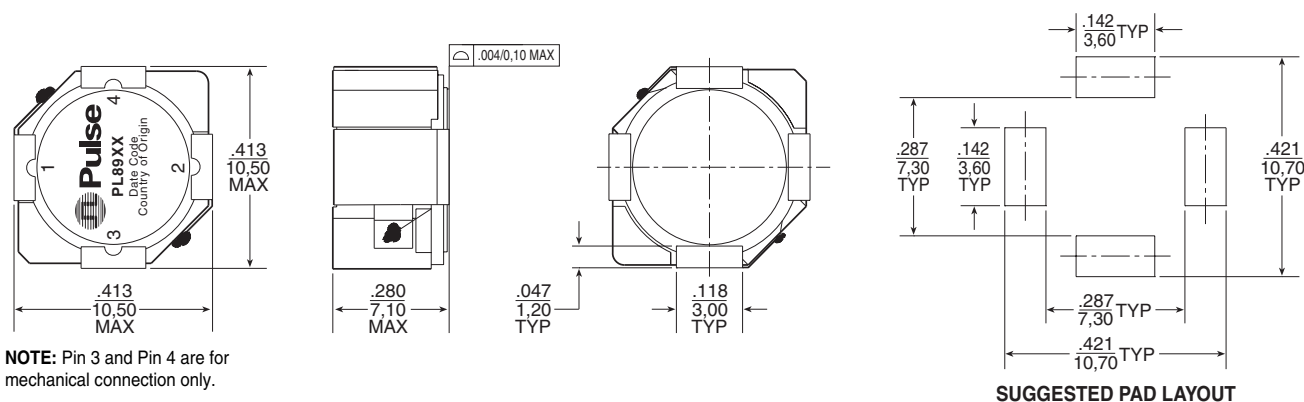

Schematic

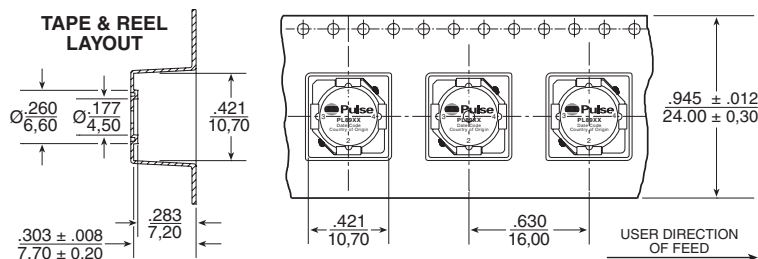
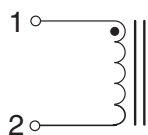

Weight 4.0 grams
Tape & Reel 400/reel
Dimensions: $\frac{\text{Inches}}{\text{mm}}$
 Unless otherwise specified,
 all tolerances are $\pm \frac{.010}{0.25}$

SMT POWER INDUCTORS

Shielded Drum Core - PL89XX Series



Notes from Tables

1. Temperature of the component (ambient plus temperature rise) must be within specified operating temperature range.
2. The rated current as listed is either the saturation current or the heating current depending on which value is lower.
3. The saturation current is the current which causes the inductance to drop to 75% of its initial inductance at zero bias. This current is determined by placing the component at room ambient (25°C), and applying a short duration pulse current (to eliminate self-heating effects) to the component.
4. The heating current is the DC current, which causes the temperature of the part to increase by approximately 40°C. This current is determined by extending the terminals of the component with 30mm length 28 gauge buss wires and applying the current to the device for 30 minutes. The temperature is measured by placing the thermocouple between the winding and the shield.
5. In high volt*time applications, additional heating in the component can occur due to core losses in the inductor which may necessitate derating the current in order to limit the temperature rise of the component. In order to determine the approximate total loss (or temperature rise) for a given application, both copper losses and core losses should be taken into account.

Inductance vs Current Characteristics

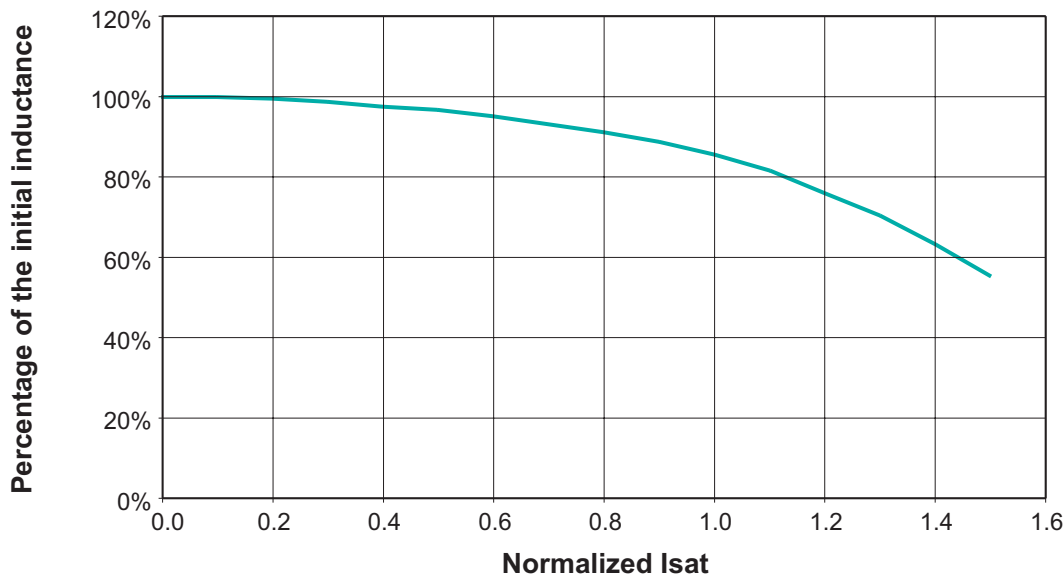

For More Information:

UNITED STATES (Worldwide)	Pulse Northern Europe	Pulse Southern Europe	Pulse China Headquarters	Pulse North China	Pulse South Asia	Pulse North Asia
2 Pearl Buck Court Bristol, PA 19007 U.S.A. http://www.pulseeng.com TEL: 215 781 6400 FAX: 215 781 6403	3 Huxley Road Surrey Research Park Guildford, Surrey GU2 5RE United Kingdom TEL: 44 1483 401700 FAX: 44 1483 401701	Zone Industrielle F-39270 Orgelet France TEL: 33 3 84 35 04 04 FAX: 33 3 84 25 46 41	No. 1 Industrial District Changan, Dongguan China TEL: 86 769 85538070 FAX: 86 769 85538870	Room 1503 XinYin Building No. 888 YiShan Road Shanghai 200233 China TEL: 86 21 54643211/2 FAX: 86 21 54643210	150 Kampong Ampat #07-01/02 KA Centre Singapore 368324 TEL: 65 6287 8998 FAX: 65 6280 0080	No. 26 Kao Ching Road Yang Mei Chen Taoyuan Hsien Taiwan, R. O. C. TEL: 886 3 4641811 FAX: 886 3 4641911

Performance warranty of products offered on this data sheet is limited to the parameters specified. Data is subject to change without notice. Other brand and product names mentioned herein may be trademarks or registered trademarks of their respective owners.

© Copyright, 2006. Pulse Engineering, Inc. All rights reserved.