

# MIL-STD-1553 Transformers

Low profile 3.3V Pulse Transformers

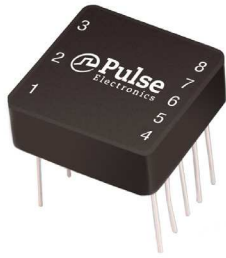

- ⊕ Dual ratio in a single transformer package (see Schematic)
- ⊕ Operating and Storage Temperature: -55 °C to +125 °C
- ⊕ Weight: ≤5.0 grams
- ⊕ Applicable specifications
  - MIL-STD-1553B
  - MIL-PRF-21038
  - MIL-STD-202
  - ISO 9001

⊕ Maximum Reflow Temperature for SMT parts: 235 deg C

Electrical Specifications @ 25°C										
Part Number	Terminals	Ratio (±3%)	DC Resistance (Ω MAX)	Impedance (Ω MIN)	Droop	Overshoot	CMR	Frequency Range (No Load)	IR @ 250Vdc (MIN)	DWV
Q1553-70	1-3:4-8 1-3:5-7	1.0CT:3.0CT 1.0CT:2.15CT	1-3 = 0.35 4-8 = 3.50	4-8 4000	20% MAX	±1V MIN	45db MIN	75kHz to 1MHz	10K MΩ	100 Vrms
SMQ1553-70	1-3:4-8 1-3:5-7	1CT:3CT 1CT:2.15CT	(1-3) .35 (4-8) 3.5	4-8 4000	20% max	±1V MAX	45dB MIN	75kHz to 1MHz	10K MΩ	100 Vrms
GL1553-71	1-3:4-8 1-3:5-7	1CT:3.54CT 1CT:2.50CT	(1-3) 0.35 (4-8) 3.5	4-8 4000	20% max	±1V MAX	45dB MIN	75kHz to 1MHz	10K MΩ	100 Vrms
DGL1553-71	1-3:1613/5-7:12-9 1-3:15-14/5-7:11-10	1CT:3.54CT 1CT:2.5CT	(1-3),(5-7) 0.35 (16-13),(12-9) 3.5	16-13 & 12-9 4000	20% max	±1V MAX	45dB MIN	75kHz to 1MHz	10K MΩ	100 Vrms
TQ1553-71	1-3:4-8 1-3:5-7	1CT:3.54CT 1CT:2.5CT	(1-3) 0.35 (4-8) 3.5	4-8 4000	20% max	±1V MAX	45dB MIN	75kHz to 1MHz	10K MΩ	100 Vrms

## Mechanical

## Schematic

Q1553-70

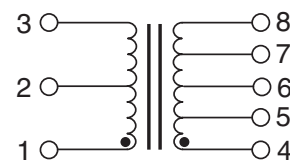
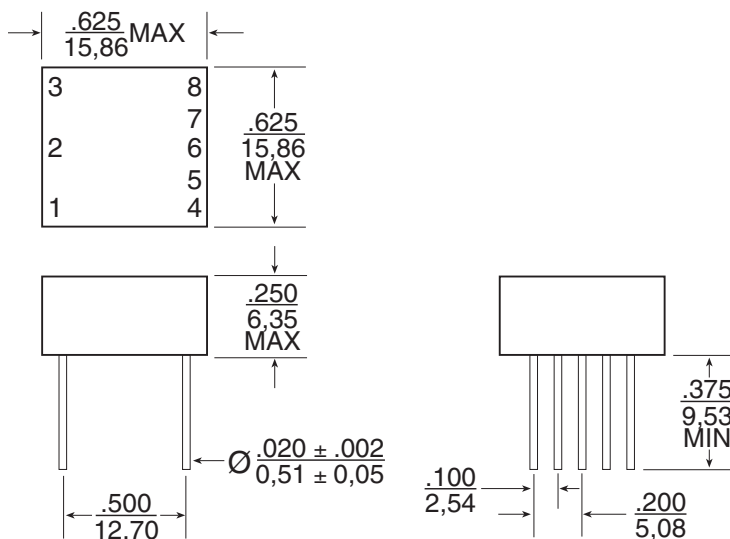

### Notes:

1. All dimensions are in inches.
2. Tolerances: .xx = +.008
3. All specifications and dimensions are subject to change without notice.
4. MSL - 1
5. Tube - 20 pieces

# MIL-STD-1553 Transformers

Low profile 3.3V Pulse Transformers

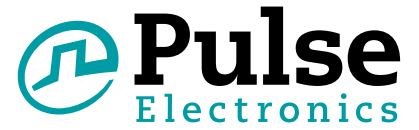

## Mechanical

## Schematic

SMQ1553-70

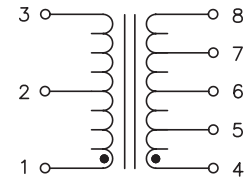
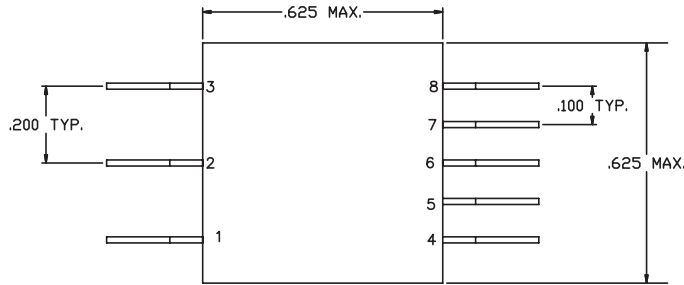

### Notes:

1. All dimensions are in inches.
2. Tolerances: .xx = +.008
3. All specifications and dimensions are subject to change without notice.
4. MSL - 3
5. Tape & Reel Size - 300

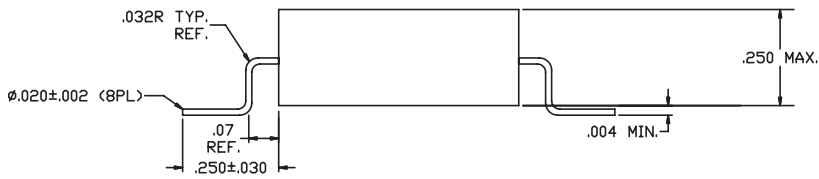

## Mechanical

## Schematic

GL1553-71

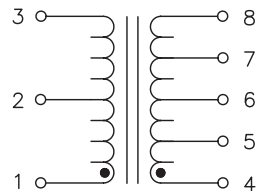
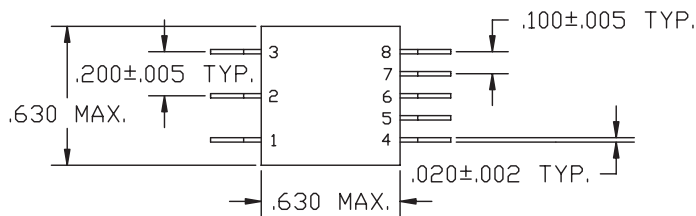

### Notes:

1. All dimensions are in inches.
2. Tolerances: .xx = +.008
3. All specifications and dimensions are subject to change without notice.
4. MSL - 3
5. Tape & Reel Size - 350

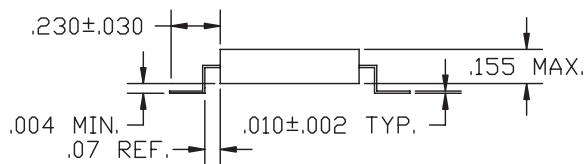

# MIL-STD-1553 Transformers

Low profile 3.3V Pulse Transformers



## Mechanical

## Schematic

DGL1553-71

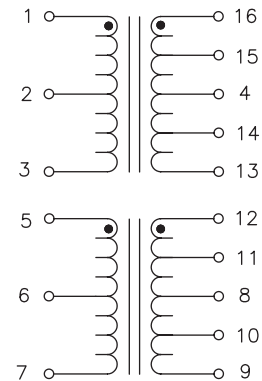
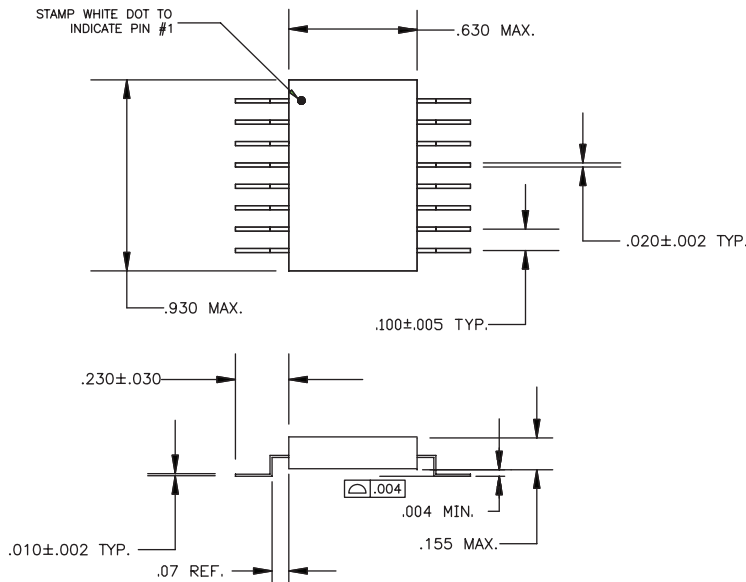

### Notes:

1. All dimensions are in inches.
2. Tolerances: .xx = +.008
3. All specifications and dimensions are subject to change without notice.
4. MSL - 3
5. Tape & Reel Size - 300

## Mechanical

## Schematic

TQ1553-71

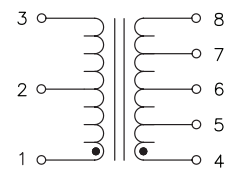
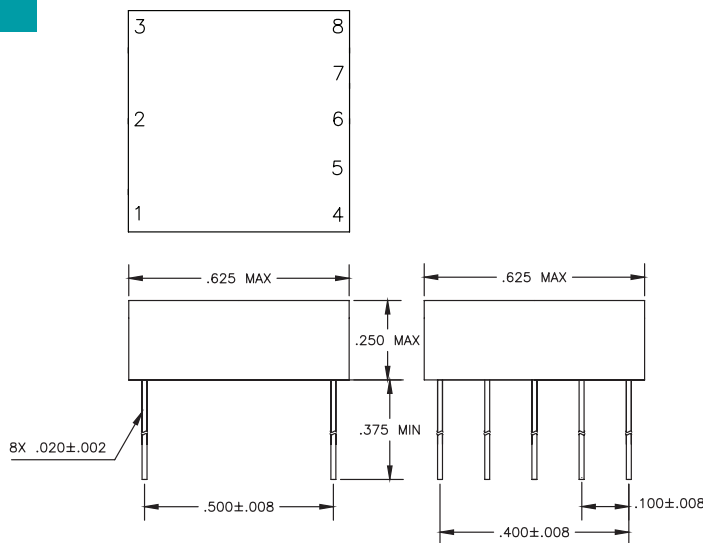

### Notes:

1. All dimensions are in inches.
2. Tolerances: .xx = +.008
3. All specifications and dimensions are subject to change without notice.
4. MSL - 1
5. Tube - 20 pieces

## For More Information

**Pulse North America Headquarters**  
Two Pearl Buck Court  
Bristol, PA 19007  
U.S.A.

**Pulse Europe**  
Zeppelinstrasse 15  
71083 Herrenberg  
Germany

**Pulse China Headquarters**  
B402, Shenzhen Academy of  
Aerospace Technology Bldg.  
10th Kejian Road  
High-Tech Zone  
Nanshan District  
Shenzhen, PR China 518057  
Tel: 86 755 33966678  
Fax: 86 755 33966700

**Pulse North China**  
Room 2704/2705  
Super Ocean Finance Ctr.  
2067 Yan An Road West  
Shanghai 200336  
China  
Tel: 86 21 62787060  
Fax: 86 21 62786973

**Pulse South Asia**  
135 Joo Seng Road  
#03-02  
PM Industrial Bldg.  
Singapore 368363

**Pulse North Asia**  
3F No. 198, Zhongyuan Road  
Zhongli City  
Taoyuan County (32068)  
Taiwan  
Tel: 886 3 4356768  
Fax: 886 3 4356823

Tel: 215 781 6400  
Fax: 215 781 6403

Tel: 49 7032 7806 0  
Fax: 49 7032 7806 12

Tel: 65 6287 8998  
Fax: 65 6287 8998

Performance warranty of products offered on this data sheet is limited to the parameters specified. Data is subject to change without notice. Other brand and product names mentioned herein may be trademarks or registered trademarks of their respective owners. © Copyright, 2013. Pulse Electronics, Inc. All rights reserved.