

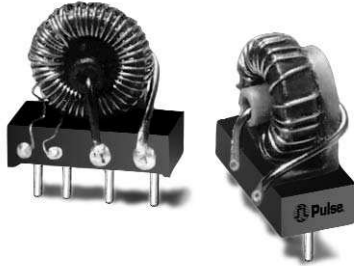



500kHz THT CURRENT SENSE TRANSFORMERS & INDUCTORS



-  Frequency range from 200 to 500kHz
-  1250V_{RMS} isolation
-  20 Amp peak sense current

Electrical Specifications @ 25°C — Operating Temperature -40°C to 130°C

Part Number Inductor	Part Number Transformer	RT ¹ (Ω)	Secondary Turns ² N _s	Secondary Inductance ³ (μH MIN)	DCR Secondary (Ω MAX)	DCR Primary (Ω)	V _s (mV)
PE-52876	PE-64976	1.50	10	150	.055	.006	30
PE-52877	PE-64977	3.00	20	600	.097	.006	60
PE-52878	PE-64978	7.50	50	4000	.240	.006	160

NOTES: 1. Terminating resistance for .15 Volt/Amp
2. ±1 turn

3. @ 100kHz, @ V_s

Mechanicals

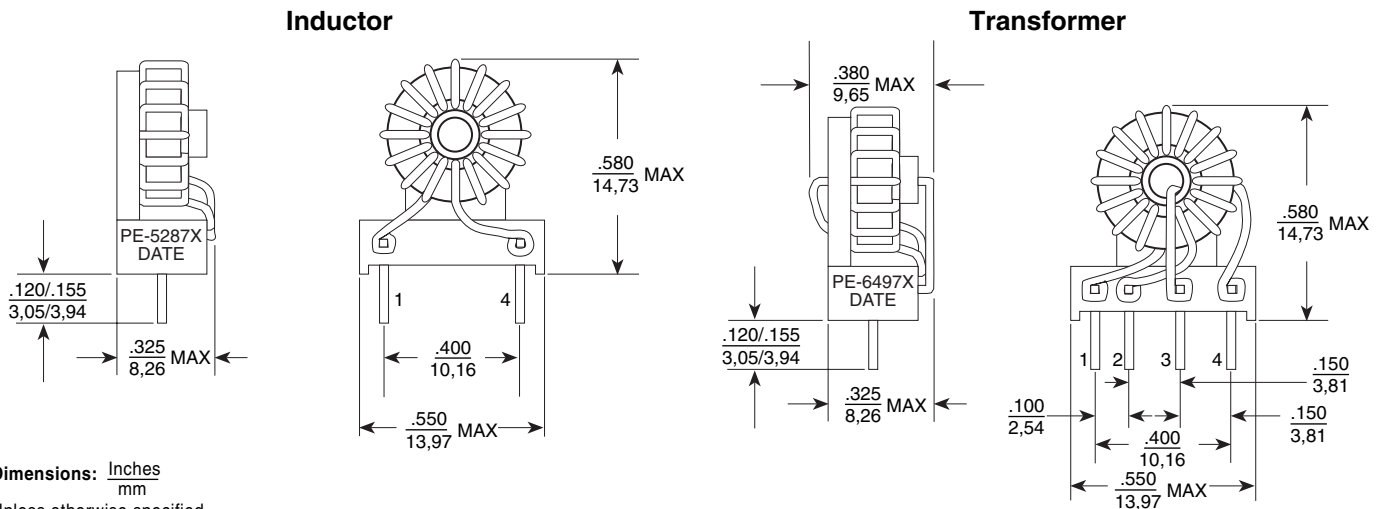

Dimensions: $\frac{\text{Inches}}{\text{mm}}$
Unless otherwise specified,
all tolerances are $\pm .010$
 $0,25$

Schematics

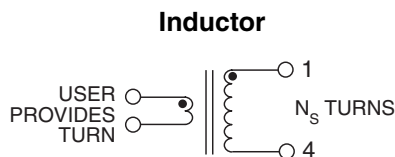

PE-52876, PE-52877, PE-52878

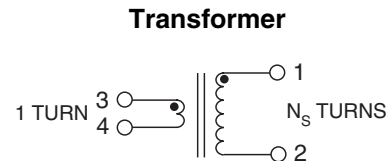

PE-64976, PE-64977, PE-64978

For More Information :

UNITED STATES (Worldwide)

12220 World Trade Drive
San Diego, CA 92128
U.S.A.
<http://www.pulseeng.com>
TEL: 858 674 8100
FAX: 858 674 8262

UNITED KINGDOM (Northern Europe)

1 & 2 Huxley Road
The Surrey Research Park
Guildford, Surrey GU2 5RE
Orgelet
United Kingdom
TEL: 44 1483 401700
FAX: 44 1483 401701

FRANCE (Southern Europe)

Zone Industrielle
F-39270
Orgelet
France
TEL: 33 3 84 35 04 04
FAX: 33 3 84 25 46 41

SINGAPORE (Southern Asia)

150 Kampong Ampat
#07-01/02
KA Centre
Singapore 368324
TEL: 65 6287 8998
FAX: 65 6280 0080

TAIWAN, R.O.C. (Northern Asia)

3F-4, No. 81, Sec. 1
HsinTai Wu Road
Hsi-Chih, Taipei Hsien
Taiwan, R.O.C.
Tel: 886 2 2698 0228
FAX: 886 2 2698 0948

HONG KONG (China/Hong Kong)

9/F, Phase 2, Tai Sang
Shatin Warehouse Centre
6 Wong Chuk Yeung Street
Fotan, Shatin, Hong Kong
TEL: 852 2788 6588
FAX: 852 2776 1055

DISTRIBUTOR

Performance warranty of products offered on this data sheet is limited to the parameters specified. Data is subject to change without notice. Other brand and product names mentioned herein may be trademarks or registered trademarks of their respective owners.

 Printed on recycled paper. ©2003, Pulse Engineering, Inc.

P591.A (5/03)