





SMT POWER INDUCTORS

Shielded Toroid Series - Ros1/Ros2 Series



TWO PACKAGE SIZES:

-  **Height:** 3.2mm and 5.3mm Max
-  **Footprint:** 8.1mm x 5.3mm and 14.0mm x 10.2mm
-  **Current Rating:** up to 5A
-  **Inductance Range:** .51 μ H to 357 μ H

Electrical Specifications @ 25°C — Operating Temperature -40°C to +130°C

Pulse Part Number	Inductance @ I _{rated} (μ H Min)	I _{rated} (A)	DCR (m Ω)		Inductance @ 0A _{DC} (μ H +/- 15%)	Reference ET (V \cdot μ sec)	Trise Factor (K0)	Coreloss Factor (K1)	ET Factor (K2)
			TYP	MAX					
Ros 1 Series									
P0430	0.51	2.00	14	16.1	.7	.8	1.45	1.27E-11	476.2
P0431	0.76	1.90	18	20.7	1.1	.8	1.45	1.27E-11	370.4
P0432	0.85	1.50	18	20.7	1.1	1.2	1.45	1.27E-11	370.4
P0433	1.44	1.20	28	32.2	1.9	1.8	1.45	1.27E-11	277.8
P0434	1.87	1.20	34	39.1	2.6	1.8	1.45	1.27E-11	238.1
P0435	2.72	1.00	40	46	3.9	2.3	1.45	1.27E-11	196.1
P0436	4.33	0.70	73	84	6.0	3.1	1.45	1.27E-11	158.7
P0437	5.35	0.60	100	115	7.1	3.3	1.45	1.27E-11	144.9
P0438	8.84	0.50	140	161	12.2	4.4	1.45	1.27E-11	111.1
P0439	10.79	0.45	155	178	14.7	5.0	1.45	1.27E-11	101.0
P0440	17.59	0.34	250	288	23.8	6.5	1.45	1.27E-11	79.4
P0441	25.50	0.29	280	322	33.8	8.4	1.45	1.27E-11	66.7
P0442	35.80	0.24	440	506	49	9.8	1.45	1.27E-11	55.6
P0443	52.70	0.20	650	747	72	12	1.45	1.27E-11	45.7
P0444	79	0.17	1050	1208	110	14	1.45	1.27E-11	37.0
P0445	88	0.16	1065	1225	122	15	1.45	1.27E-11	35.1
P0446	127	0.14	1600	1840	179	18	1.45	1.27E-11	29.0
Ros 2 Series									
P0450	0.51	5.00	8.1	9.3	.65	3	.508	8.87E-11	181.8
P0451	0.67	5.00	8.7	10	.86	3.1	.508	8.87E-11	151.5
P0452	1.09	5.00	11.4	13.1	1.5	.5	.508	8.87E-11	113.6
P0453	1.53	5.00	13.0	15	2.3	1.0	.508	8.87E-11	90.9
P0454	1.78	3.00	15.0	17.3	2.3	7.5	.508	8.87E-11	90.9
P0455	3.74	2.50	23.0	26.5	5.1	10.5	.508	8.87E-11	60.6
P0456	4.76	2.00	26.1	30	6.3	13	.508	8.87E-11	56.8
P0457	5.61	1.80	33.0	38	7.5	14	.508	8.87E-11	50.5
P0458	9.09	1.50	70.4	81	13.2	15	.508	8.87E-11	39.5
P0459	11.47	1.30	60.0	69	15.5	21	.508	8.87E-11	35.0
P0460	22.95	1.00	90.4	104	34	31	.508	8.87E-11	24.6
P0461	39.10	0.90	123.5	142	57.2	39	.508	8.87E-11	18.9
P0462	40.80	0.80	240.0	276	62.5	35	.508	8.87E-11	18.2
P0463	69.70	0.60	245.2	282	100	55	.508	8.87E-11	14.0
P0464	76.50	0.50	305.2	351	103	54	.508	8.87E-11	14.2
P0465	137	0.40	480.9	553	180	78	.508	8.87E-11	10.0
P0466	182	0.35	681.7	784	254	87	.508	8.87E-11	8.7
P0467	272	0.30	1030.4	1185	422.5	105	.508	8.87E-11	7.0
P0468	357	0.25	1200.0	1380	500	130	.508	8.87E-11	6.1

SMT POWER INDUCTORS

Shielded Toroid Series - Ros1/Ros2 Series



Notes:

1. Temperature rise is 55°C in typical buck or boost circuits with the rated I_{DC} current and reference ET applied to the inductor.
2. Total loss in the inductor is 80 mW (ROS 1) and 280 mW (ROS 2) for 55°C temperature rise above ambient.
3. To estimate temperature rise in a given application, you must determine the total losses (copper losses + core losses) and apply the following formula:
Temp Rise (C) = (Total Losses (mW))^{.833} * KO (from table)
4. To determine copper losses, calculate:
Copper Loss (mW) = I_{DC}² x DCR
5. For core loss in mWatts, using frequency f (in Hz) and operating flux density B (in Gauss), calculate:
Core Loss (mW) = k₂ * f^{1.26} * B^{2.11}
6. For flux density (B), calculate ET (V-µsec) for the application, and multiply by ET₁₀ factor from the table.

Mechanical

Schematic

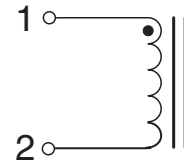
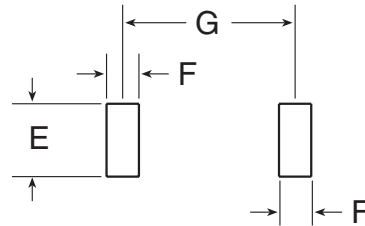
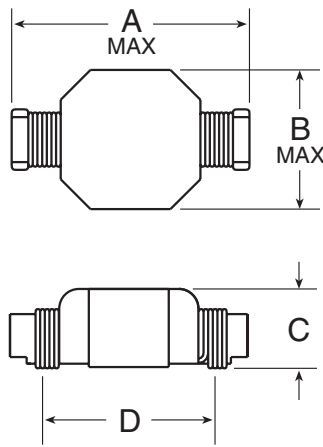

Suggested Pad Layout

	ROS 1	ROS 2
Weight	0.29 grams	1.1 grams
Tape & Reel	2000/reel	600/reel
Dimensions:	$\frac{\text{Inches}}{\text{mm}}$	
Unless otherwise specified, all tolerances are $\pm \frac{.010}{0,25}$		

PKG	A	B	C	D	E	F	G
ROS 1	.335 8,51	.225 5,72	.125 3,18	.250 6,35	.100 2,54	.050 1,27	.250 6,35
ROS 2	.545 13,84	.390 9,91	.215 5,46	.440 11,18	.120 3,05	.065 1,65	.440 11,18

ROS 1

ROS 2

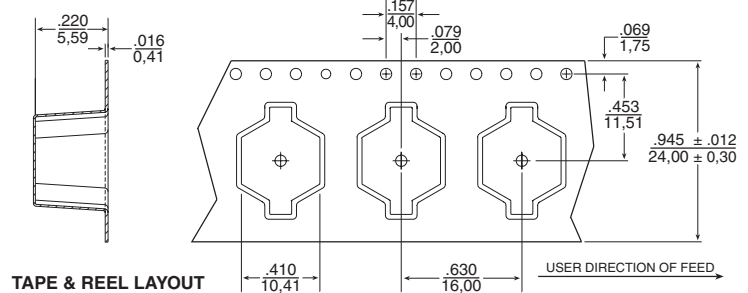
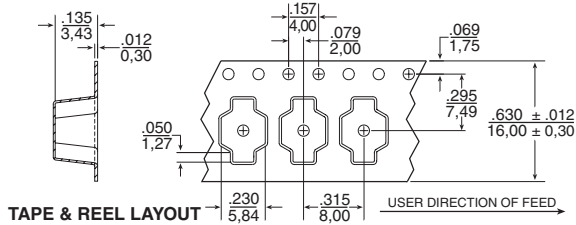

For More Information:

Pulse Worldwide Headquarters 12220 World Trade Drive San Diego, CA 92128 U.S.A. www.pulseeng.com TEL: 858 674 8100 FAX: 858 674 8262	Pulse Northern Europe 3 Huxley Road Surrey Research Park Guildford, Surrey GU2 5RE United Kingdom TEL: 44 1483 401700 FAX: 44 1483 401701	Pulse Southern Europe Zone Industrielle F-39270 Orgelet France TEL: 33 3 84 35 04 04 FAX: 33 3 84 25 46 41	Pulse China Headquarters No. 1 Industrial District Changan, Dongguan China TEL: 86 769 85538070 FAX: 86 769 85538870	Pulse North China Room 1503 XinYin Building No. 888 YiShan Road Shanghai 200233 China TEL: 86 21 54643211/2 FAX: 86 21 54643210	Pulse South Asia 150 Kampong Ampat #07-01/02 KA Centre Singapore 368324 TEL: 65 6287 8998 FAX: 65 6280 0080	Pulse North Asia No. 26 Kao Ching Road Yang Mei Chen Taoyuan Hsien Taiwan, R. O. C. TEL: 886 3 4641811 FAX: 886 3 4641911
---	--	---	---	---	--	---

Performance warranty of products offered on this data sheet is limited to the parameters specified. Data is subject to change without notice. Other brand and product names mentioned herein may be trademarks or registered trademarks of their respective owners.
 © Copyright, 2006. Pulse Engineering, Inc. All rights reserved.