





HOME PLUG TRANSFORMER



-  Supports HomePlug 1.0 Technology
-  Matched to leading HomePlug Analog Front End Powerline Interface
-  Couples Home Powerline to HomePlug Analog Front End (AFE)
-  Small form factor

Electrical Specifications @ 25°C — Operating Temperature -40°C to +85°C

Part Number	Mounting	Turns Ratio (±2%) (1-3):(6-4)	Inductance (@ 100 kHz, 0.01 Vrms) (1-3)	Isolation Voltage (Vrms)
B6080	SMT	1CT:1CT	250 µH MIN	2000

NOTE: Transformers are shipped in tubes, unless Tape & Reel packaging is specified by adding a "T" suffix to the part number (ex: B6080T).

Mechanical

Schematic

B6080

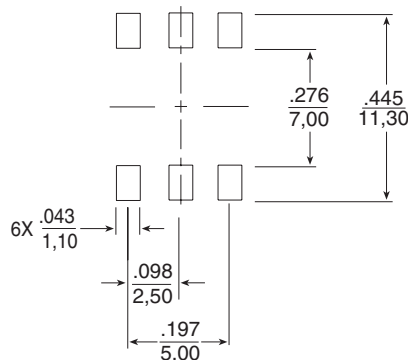
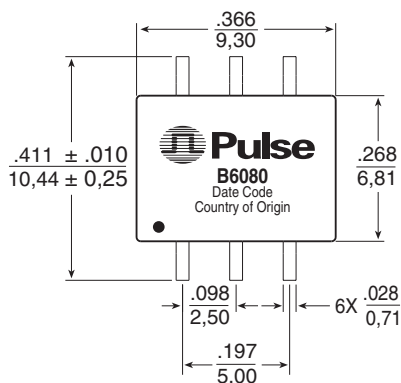

SUGGESTED PAD LAYOUT

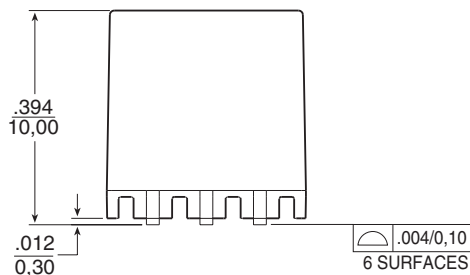
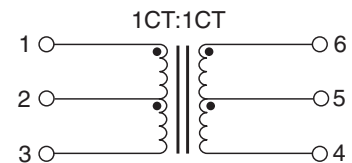

Weight3.5 grams
 Tape & Reel180/reel
 Tube50/tube

Dimensions: $\frac{\text{Inches}}{\text{mm}}$
 Unless otherwise specified, all tolerances are $\pm \frac{.010}{0.25}$

HOME PLUG TRANSFORMER

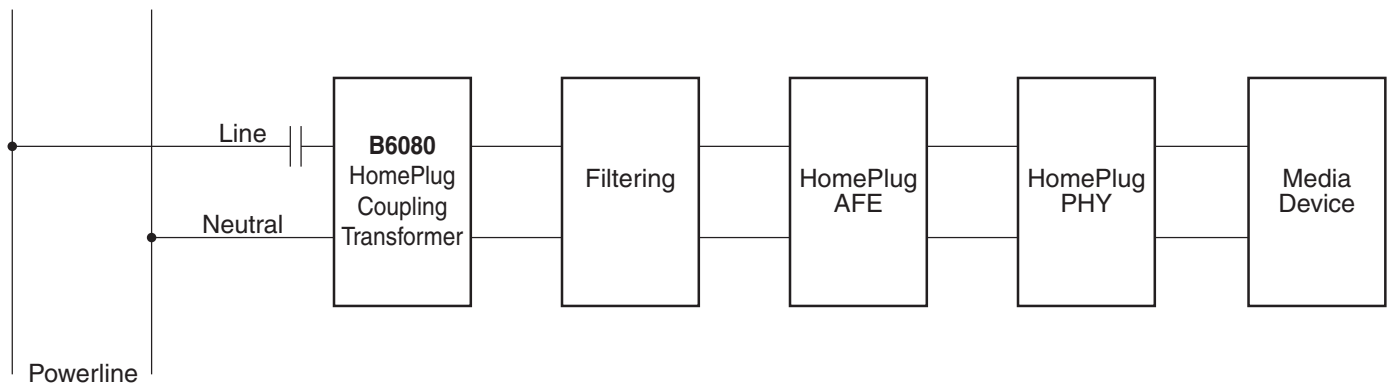
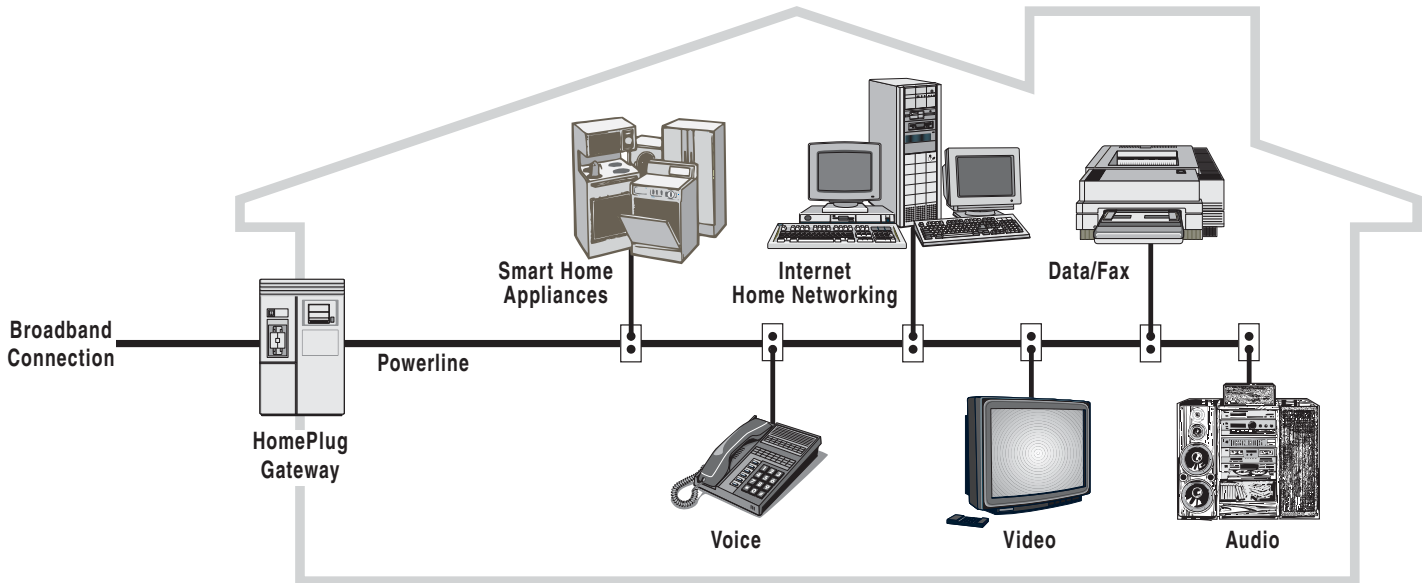

For More Information :

UNITED STATES (Worldwide)	UNITED KINGDOM (Northern Europe)	FRANCE (Southern Europe)	SINGAPORE (Southern Asia)	TAIWAN, R.O.C. (Northern Asia)	HONG KONG (China/Hong Kong)	DISTRIBUTOR
12220 World Trade Drive San Diego, CA 92128 U.S.A. http://www.pulseeng.com TEL: 858 674 8100 FAX: 858 674 8262	1 & 2 Huxley Road The Surrey Research Park Guildford, Surrey GU2 5RE United Kingdom TEL: 44 1483 401700 FAX: 44 1483 401701	Zone Industrielle F-39270 Orgelet France TEL: 33 3 84 35 04 04 FAX: 33 3 84 25 46 41	150 Kampong Ampat #07-01/02 KA Centre Singapore 368324 TEL: 65 6287 8998 FAX: 65 6280 0080	3F-4, No. 81, Sec. 1 HsinTai Wu Road Hsi-Chih, Taipei Hsien Taiwan, R.O.C. Tel: 886 2 2698 0228 FAX: 886 2 2698 0948	9/F, Phase 2, Tai Sang Shatin Warehouse Centre 6 Wong Chuk Yeung Street Fotan, Shatin, Hong Kong TEL: 852 2788 6588 FAX: 852 2776 1055	

Performance warranty of products offered on this data sheet is limited to the parameters specified. Data is subject to change without notice. Other brand and product names mentioned herein may be trademarks or registered trademarks of their respective owners.