



COMMON MODE CHOKES

For Telecom Applications, Extended Temperature Range



-  8-pin, low-profile small surface mount package
-  Optimized for radiated emissions to improve noise immunity
-  235°C peak reflow temperature rating

Electrical Specifications @ 25°C — Operating Temperature -40°C to +85°C

| Part Number | Common Mode Attenuation (dB MIN) | | | | Primary Inductance OCL (μH MIN) | DCR (Ω MAX) |
|-------------|----------------------------------|--------|---------|---------|---------------------------------|-------------|
| | 1 MHz | 10 MHz | 100 MHz | 500 MHz | | |
| T8051 | -10 | -15 | -12 | -5 | 35 | .15 |
| T8052 | -10 | -15 | -12 | -5 | 35 | .20 |
| T8055 | -8 | -12 | -15 | -5 | 5 | .25 |

Mechanical

Schematics

BIE

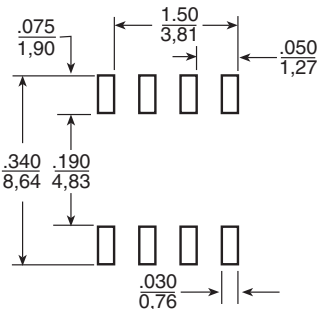
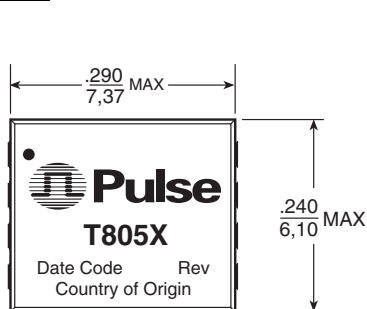

SUGGESTED PAD LAYOUT

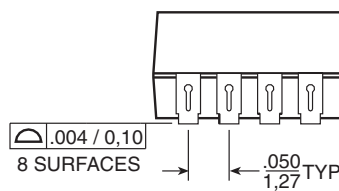
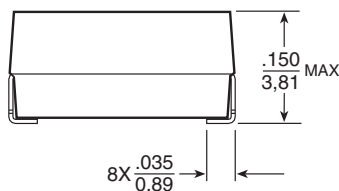

Weight0.2 grams (max)
 Tape & Reel1750/reel
 Tube80/tube

Dimensions: Inches
 mm
 Unless otherwise specified,
 all tolerances are ± .010
 0,25

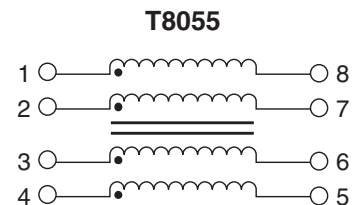
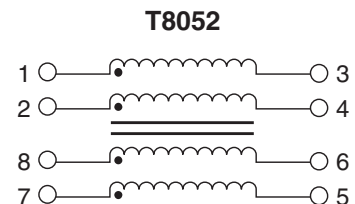
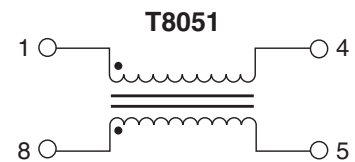

For More Information :

| UNITED STATES (Worldwide) | UNITED KINGDOM (Northern Europe) | FRANCE (Southern Europe) | SINGAPORE (Southern Asia) | TAIWAN, R.O.C. (Northern Asia) | HONG KONG (China/Hong Kong) | DISTRIBUTOR |
|---|--|---|---|---|---|-------------|
| 12220 World Trade Drive San Diego, CA 92128 U.S.A. http://www.pulseeng.com TEL: 858 674 8100 FAX: 858 674 8262 | 1 & 2 Huxley Road The Surrey Research Park Guildford, Surrey GU2 5RE United Kingdom TEL: 44 1483 401700 FAX: 44 1483 401701 | Zone Industrielle F-39270 Orgelet France TEL: 33 3 84 35 04 04 FAX: 33 3 84 25 46 41 | 150 Kampong Ampat #07-01/02 KA Centre Singapore 368324 TEL: 65 6287 8998 FAX: 65 6280 0080 | 3F-4, No. 81, Sec. 1 HsinTai Wu Road Hsi-Chih, Taipei Hsien Taiwan, R.O.C. Tel: 886 2 2698 0228 FAX: 886 2 2698 0948 | 9/F, Phase 2, Tai Sang Shatin Warehouse Centre 6 Wong Chuk Yeung Street Fotan, Shatin, Hong Kong TEL: 852 2788 6588 FAX: 852 2776 1055 | |

Performance warranty of products offered on this data sheet is limited to the parameters specified. Data is subject to change without notice. Other brand and product names mentioned herein may be products and/or registered trademarks of their respective owners.