

Common Mode Chokes

For DSL and Telecom Applications



- Family of 2-wire common mode chokes
- Low profile surface mount package
- Cost-effective construction with Pulse SLIC patented technology
- Range suited for many DSL and Telecom applications

Electrical Specifications @ 25°C / 80 Vdc - Operating Temperature -40°C to +85°C

RoHS-Compliant Part Number	OCL (mH +50% / -30%)	L (µH TYP)	DCR (Ω MAX)	Current Rating (mAdc)	Isolation (Vrms)
T8114NLT	4.70	0.4	0.7	400	500

Notes: Other custom inductance values available on request. Tube version available for sampling. Please contact Pulse Applications Engineering.

Mechanical

Schematic

T8114NL

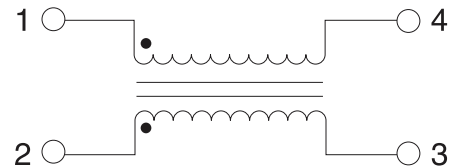
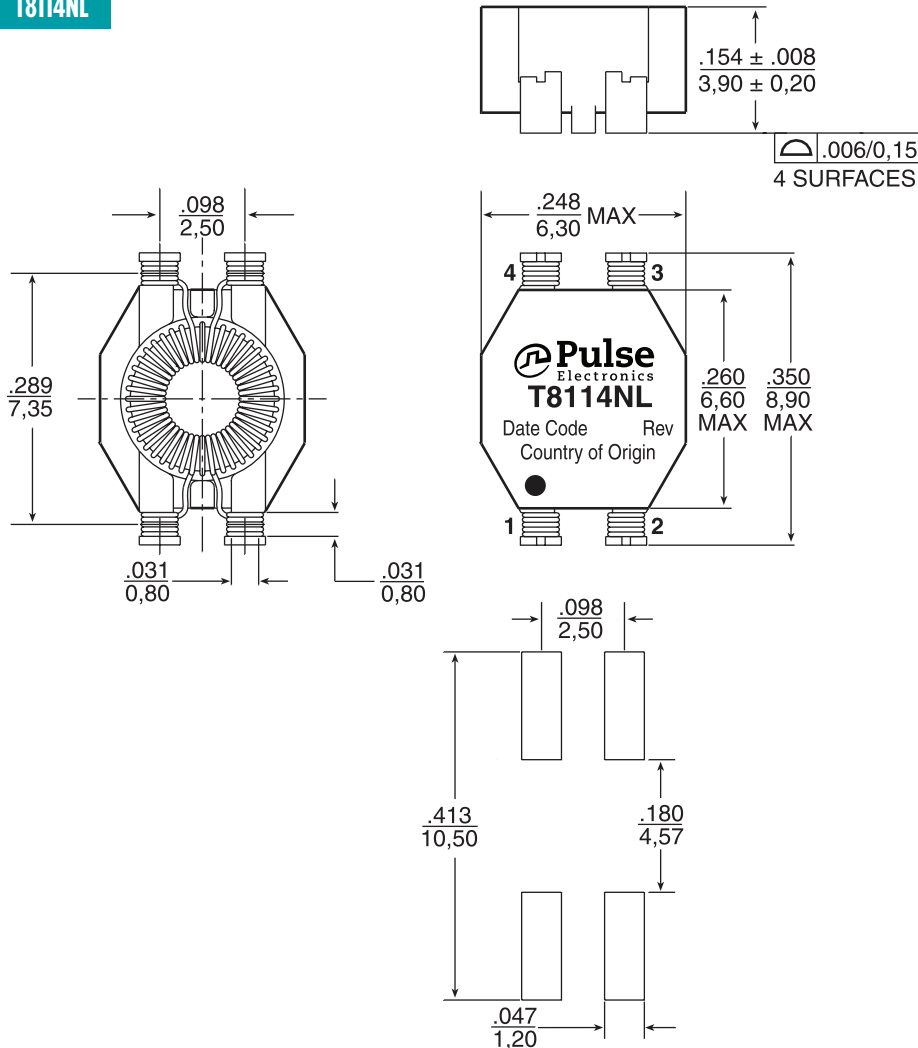

Weight0.2 grams

Tape & Reel1600/reel

Dimensions: $\frac{\text{Inches}}{\text{mm}}$

Unless otherwise specified, all tolerances are ± $\frac{.010}{0,25}$

SUGGESTED PAD LAYOUT

USA 858 674 8100

Germany 49 7032 7806 0

Singapore 65 6287 8998

Shanghai 86 21 62787060

China 86 755 33966678

Taiwan 886 3 4356768

Common Mode Chokes

For DSL and Telecom Applications

Impedance in Common Mode and Differential Mode
T8114NL (2 x 4.7mH)

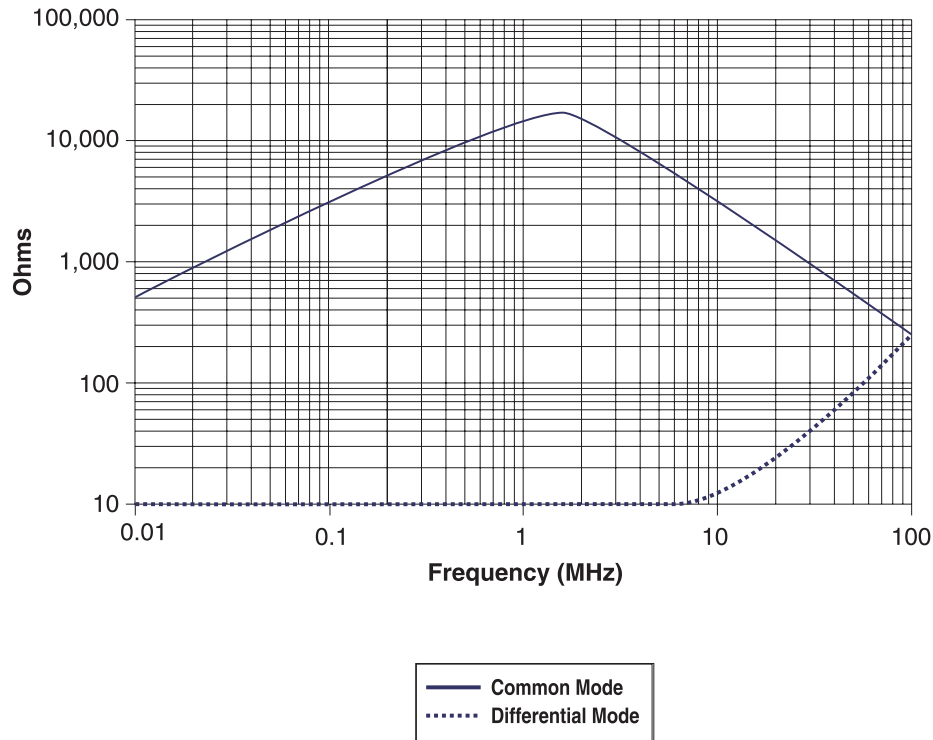

For More Information

Pulse Worldwide Headquarters

12220 World Trade Drive
San Diego, CA
92128
U.S.A.

Tel: 858 674 8100
Fax: 858 674 8262

Pulse Europe

Einsteinstrasse 1
D-71083 Herrenberg
Germany

Tel: 49 7032 78060
Fax: 49 7032 7806 135

Pulse China Headquarters

B402, Shenzhen Academy of
Aerospace Technology Bldg.
10th Kejinan Road
High-Tech Zone
Nanshan District
Shenzhen, PR China
518057
Tel: 86 755 33966678
Fax: 86 755 33966700

Pulse North China

Room 2704/2705
Super Ocean Finance
Ctr.
2067 Yan An Road
West
Shanghai 200336
China

Tel: 86 21 62787060
Fax: 86 2162786973

Pulse South Asia

135 Joo Seng Road
#03-02
PM Industrial Bldg.
Singapore 368363

Tel: 65 6287 8998
Fax: 65 6287 8998

Pulse North Asia

3F, No. 198
Zhongyuan Road
Zhongli City
Taoyuan County 320
Taiwan R. O. C.
Tel: 886 3 4356768
Fax: 886 3 4356823 (Pulse)
Fax: 886 3 4356820 (FRE)

Performance warranty of products offered on this data sheet is limited to the parameters specified. Data is subject to change without notice. Other brand and product names mentioned herein may be trademarks or registered trademarks of their respective owners. © Copyright, 2012. Pulse Electronics, Inc. All rights reserved.