

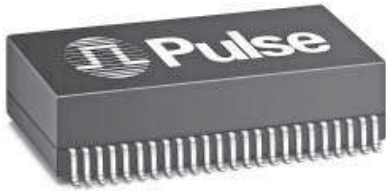







T1/CEPT/ISDN-PRI TRANSFORMER

Quad Port SMT Transformer Module

with Line Side Protection



-  RoHS peak reflow temperature rating 245°C
-  Four transmit and four receive transformers, and line side protection circuit in a surface mount package
-  Extended temperature range
-  Patented "Interlock Base" construction for high-reliability
-  IC grade transfer-molded package
-  Minimum isolation voltage: 1500 Vrms
-  UL recognized

Electrical Specifications @ 25°C — Operating Temperature -40°C to +85°C

RoHS-6 Compliant Part Number	Turns Ratio (Pri:Sec ±2%)		OCL Line Side (mH MIN)	Cw/w (pF MAX)	LL (μH MAX)	Package/ Schematic	Primary Pins	
	Transmit	Receive					Transmit	Receive
TX9032NL	1CT:1	1:1CT	1.2	35 & 35	.80 & .80	BRT	4-6, 10-12, 16-18, 22-24	48-46, 42-40, 36-34, 30-28
TX9033NL	1CT:1.14	1.14CT:1	1.2	35 & 35	1.0 & 1.0	BRT	4-6, 10-12, 16-18, 22-24	48-46, 42-40, 36-34, 30-28

NOTE: When ordering Tape & Reel packaging, add a "T" suffix to the part number (ex: TX9032NLT).

Mechanical

BRT

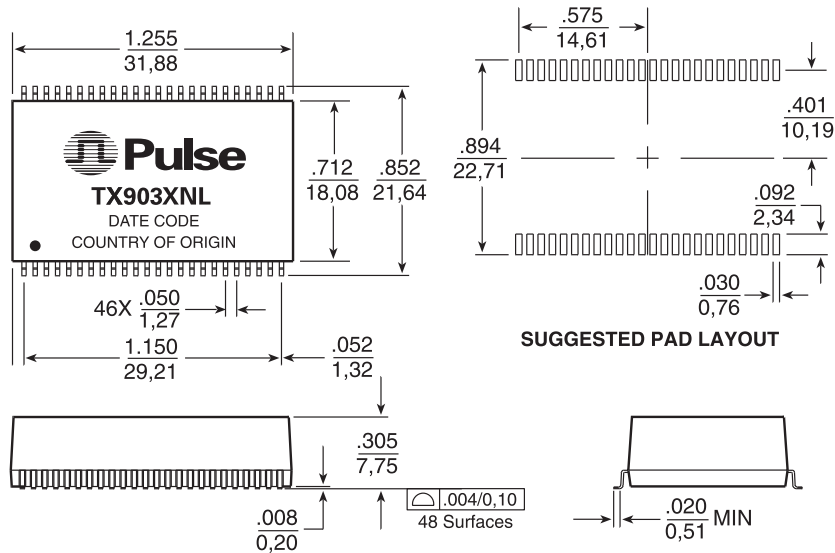

Weight 9.2 grams
Tape & Reel 150/reel
Tube 15/tube

Dimensions: $\frac{\text{Inches}}{\text{mm}}$
Unless otherwise specified, all tolerances are $\pm \frac{.010}{0.25}$

T1/CEPT/ISDN-PRI TRANSFORMER

Quad Port SMT Transformer Module

with Line Side Protection



Schematic

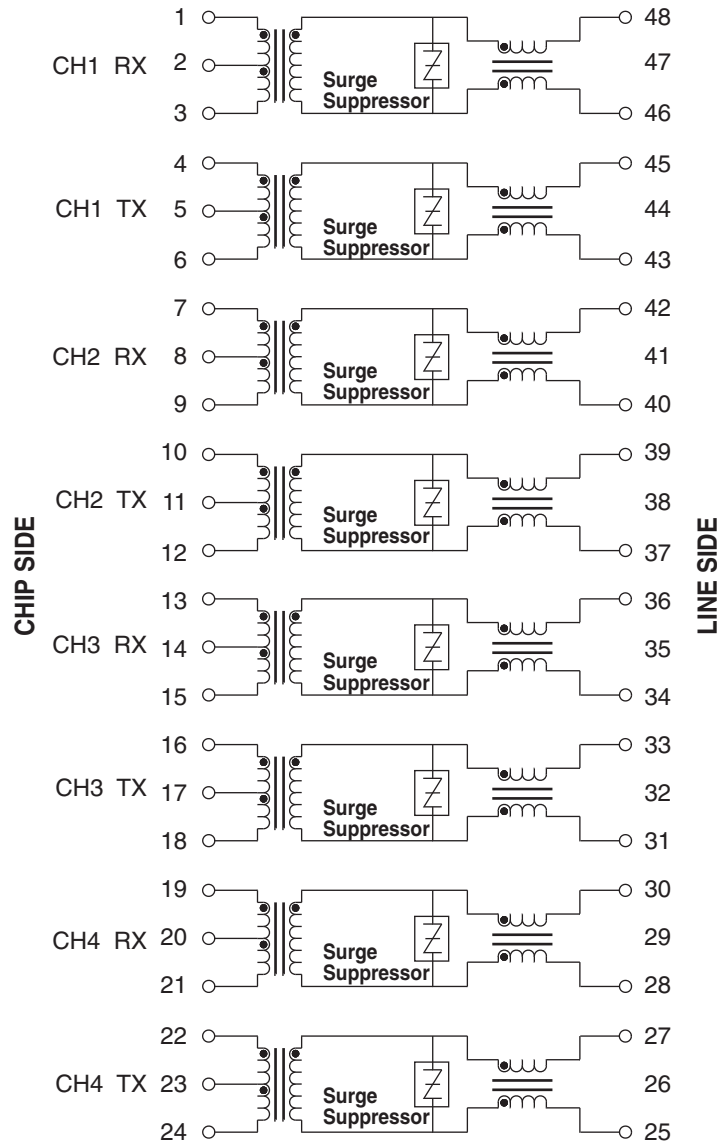

For More Information:

Pulse Worldwide Headquarters

12220 World Trade Dr.
San Diego, CA 92128
U.S.A.

www.pulseeng.com

Tel: 858 674 8100
Fax: 858 674 8262

Pulse Europe

Einsteinstrasse 1
D-71083 Herrenberg
Germany

Tel: 49 7032 7806 0

Fax: 49 7032 7806 135

Pulse China Headquarters

B402, Shenzhen Academy of
Aerospace Technology Bldg.
10th Kejinan Rd.
High-Tech Zone
Nanshan District
Shenzhen, PR China 518057

TEL: 86 755 33966678

FAX: 86 755 33966700

Pulse North China

Room 1503
XinYin Building
No. 888 YiShan Rd.
Shanghai 200233
China

Tel: 86 21 54643211/2

Fax: 86 21 54643210

Pulse South Asia

135 Joo Seng Rd.
#03-02
PM Industrial Bldg.
Singapore 368363

TEL: 65 6287 8998

FAX: 65 6280 0080

Pulse North Asia

No. 26, Kao Ching Rd.
Yang Mei Chen
Taoyuan Hsien
Taiwan
R. O. C.

Tel: 886 3 4643715

Fax: 886 3 4641911

Performance warranty of products offered on this data sheet is limited to the parameters specified. Data is subject to change without notice. Other brand and product names mentioned herein may be trademarks or registered trademarks of their respective owners.

© Copyright, 2009, Pulse Engineering, Inc. All rights reserved.