

Wireless External Antenna for 2.4 GHz Application

Single-Band Antenna with I-PEX Cable Assembly. Pulse Part Number: W1049B

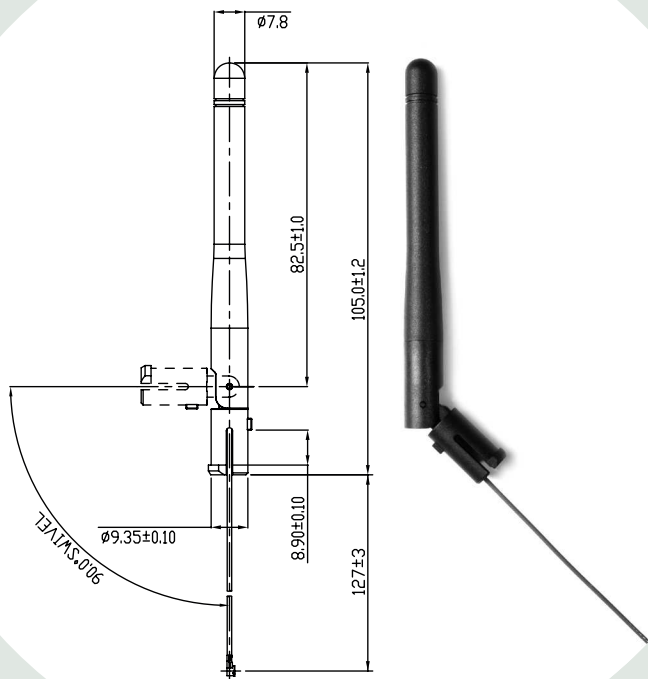

Features

- Shortest antennas in product line
- Omni-directional radiation
- For WLAN devices using WiFi (802.11b/g), Bluetooth®, ZigBee™ and other applications in the ISM 2.4GHz band
- Omnidirectional radiation pattern provides broad 360° coverage
- One-quarter wavelength dipole configuration
- Various cable length from 3 to 12 inch (76-305mm)

Connector

- I-PEX

Pansize 20/bag; 500/carton

Dimensions: $\frac{\text{Inches}}{\text{mm}}$

Unless otherwise specified, all tolerances are $\pm \frac{0.10}{0.25}$

Electrical Specifications @ +25 °C

Note: This part number is lead-free and RoHS compliant. No additional suffix or identifier is required.

Part Number	Frequency [GHz]	Max Gain [dBi]	Impedance [Ω]	Mechanical Length (in/mm)	Cable Length (in/mm)
W1049B030	2.4	2.0	50	3.25/82.5	3/76
W1049B050	2.4	2.0	50	3.25/82.5	5/127
W1049B070	2.4	2.0	50	3.25/82.5	7/178
W1049B090	2.4	2.0	50	3.25/82.5	9/229
W1049B120	2.4	2.0	50	3.25/82.5	12/305

Pulse Finland Oy

Takatie 6
 90440 Kempele, Finland
 Tel: +358 207 935 500
 Fax: +358 207 935 501
www.pulseeng.com/antennas



Wireless External Antenna for 2.4 GHz Application

Single-Band Antenna with I-PEX Cable Assembly. Pulse Part Number: W1049B

Application Notes

Omni-directional antennas provide a uniform, donut-shaped, 360° radiation pattern. The omni-directional pattern is suitable for point-to-multipoint broadcasting in all directions. This antenna is primarily used for WLAN

applications. However, it can also be used for a variety of other applications within the specified frequency range. When used as an access point, the antenna is ideally located at the center of the coverage area.

Gain Performance W1049B030

H-PLANE

2.4GHz 1.55524dBi

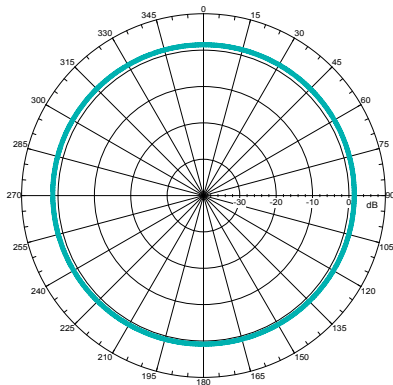

2.45GHz 1.51154dBi

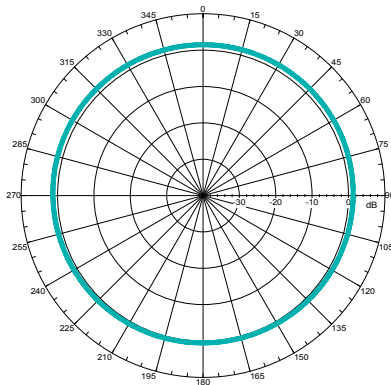

2.5GHz 1.38176dBi

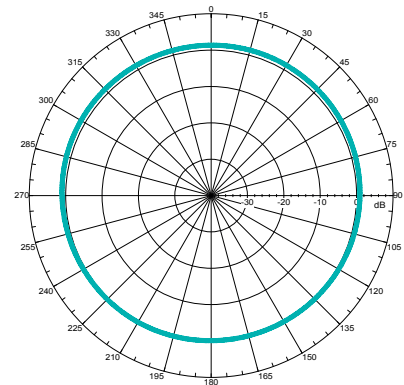

E-PLANE

2.4GHz 1.61476dBi

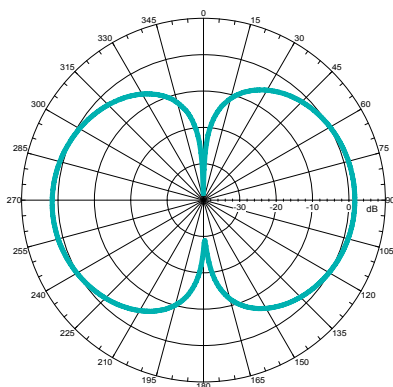

2.45GHz 1.6233dBi

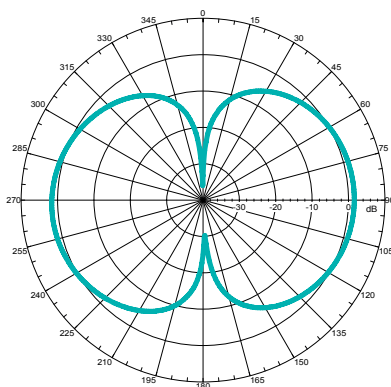

2.5GHz 1.59034dBi

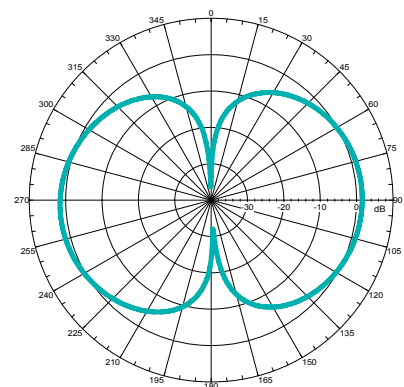

Pulse Finland Oy

Takatie 6
90440 Kempele, Finland
Tel: +358 207 935 500
Fax: +358 207 935 501

www.pulseeng.com/antennas

