

### Dual IGBTMOD™ NFH-Series Module 150 Amperes/1200 Volts

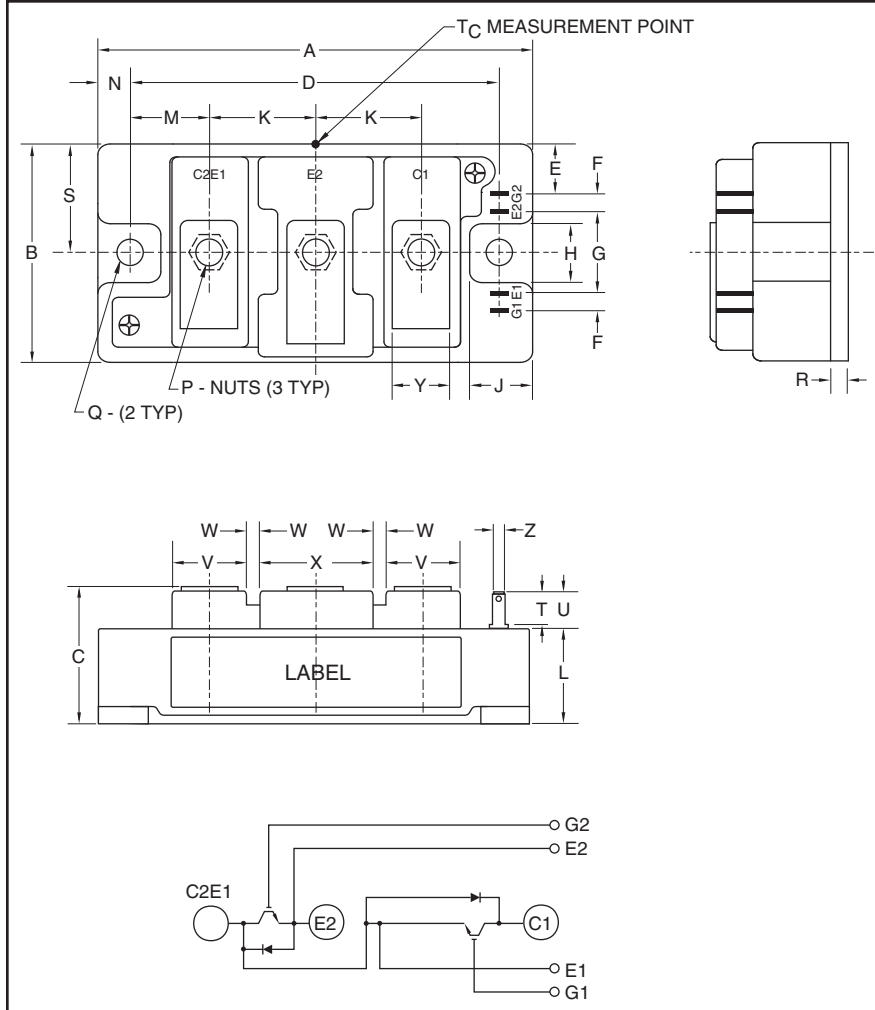

Outline Drawing and Circuit Diagram

Dimensions	Inches	Millimeters
A	3.70	94.0
B	1.89	48.0
C	1.18+0.04/-0.01	30.0+1.0/-0.5
D	3.15±0.01	80.0±0.25
E	0.43	11.0
F	0.16	4.0
G	0.71	18.0
H	0.51	13.0
J	0.53	13.5
K	0.91	23.0
L	0.83	21.2
M	0.67	17.0

Dimensions	Inches	Millimeters
N	0.28	7.0
P	M5 Metric	M5
Q	0.26 Dia.	Dia. 6.5
R	0.02	4.0
S	0.94	24.0
T	0.3	7.5
U	0.33	8.5
V	0.63	16.0
W	0.1	2.5
X	0.98	25.0
Y	0.47	12.0
Z	0.11	2.8



#### Description:

Powerex IGBTMOD™ Modules are designed for use in high frequency applications; 30 kHz for hard switching applications and 60 to 70 kHz for soft switching applications. Each module consists of two IGBT Transistors in a half-bridge configuration with each transistor having a reverse-connected super-fast recovery free-wheel diode. All components and interconnects are isolated from the heat sinking baseplate, offering simplified system assembly and thermal management.

#### Features:

- Low ESW(off)
- Discrete Super-Fast Recovery Free-Wheel Diode
- Isolated Baseplate for Easy Heat Sinking

#### Applications:

- Power Supplies
- Induction Heating
- Welders

#### Ordering Information:

Example: Select the complete part module number you desire from the table below -i.e. CM150DU-24NFH is a 1200V (V<sub>CEs</sub>), 150 Ampere Dual IGBTMOD™ Power Module.

Type	Current Rating Amperes	V <sub>CEs</sub> Volts (x 50)
CM	150	24



Powerex, Inc., 173 Pavilion Lane, Youngwood, Pennsylvania 15697 (724) 925-7272

**CM150DU-24NFH**  
**Dual IGBTMOD™ NFH-Series Module**  
 150 Amperes/1200 Volts

**Absolute Maximum Ratings,  $T_j = 25\text{ }^\circ\text{C}$  unless otherwise specified**

Ratings	Symbol	CM150DU-24NFH	Units
Junction Temperature	$T_j$	-40 to 150	$^\circ\text{C}$
Storage Temperature	$T_{stg}$	-40 to 125	$^\circ\text{C}$
Collector-Emitter Voltage (G-E Short)	$V_{CES}$	1200	Volts
Gate-Emitter Voltage (C-E Short)	$V_{GES}$	$\pm 20$	Volts
Collector Current ( $T_C = 25^\circ\text{C}$ )	$I_C$	150*	Amperes
Peak Collector Current	$I_{CM}$	300*	Amperes
Emitter Current** ( $T_C = 25^\circ\text{C}$ )	$I_E$	150*	Amperes
Peak Emitter Current**	$I_{EM}$	300*	Amperes
Maximum Collector Dissipation ( $T_C = 25^\circ\text{C}, T_j \leq 150^\circ\text{C}$ )	$P_C$	650	Watts
Maximum Collector Dissipation ( $T_C = 25^\circ\text{C}, T_j \leq 150^\circ\text{C}$ )	$P_C$	960	Watts
Mounting Torque, M5 Main Terminal	—	30	in-lb
Mounting Torque, M6 Mounting	—	40	in-lb
Weight	—	310	Grams
Isolation Voltage (Main Terminal to Baseplate, AC 1 min.)	$V_{ISO}$	2500	Volts

**Static Electrical Characteristics,  $T_j = 25\text{ }^\circ\text{C}$  unless otherwise specified**

Characteristics	Symbol	Test Conditions	Min.	Typ.	Max.	Units
Collector-Cutoff Current	$I_{CES}$	$V_{CE} = V_{CES}, V_{GE} = 0V$	—	—	1.0	mA
Gate Leakage Current	$I_{GES}$	$V_{GE} = V_{GES}, V_{CE} = 0V$	—	—	0.5	$\mu\text{A}$
Gate-Emitter Threshold Voltage	$V_{GE(th)}$	$I_C = 15\text{mA}, V_{CE} = 10V$	4.5	6.0	7.5	Volts
Collector-Emitter Saturation Voltage	$V_{CE(sat)}$	$I_C = 150\text{A}, V_{GE} = 15V, T_j = 25^\circ\text{C}$	—	5.0	6.5	Volts
		$I_C = 150\text{A}, V_{GE} = 15V, T_j = 125^\circ\text{C}$	—	5.0	—	Volts
Total Gate Charge	$Q_G$	$V_{CC} = 600V, I_C = 150\text{A}, V_{GE} = 15V$	—	680	—	nC
Emitter-Collector Voltage**	$V_{EC}$	$I_E = 150\text{A}, V_{GE} = 0V$	—	—	3.5	Volts

**Dynamic Electrical Characteristics,  $T_j = 25\text{ }^\circ\text{C}$  unless otherwise specified**

Characteristics	Symbol	Test Conditions	Min.	Typ.	Max.	Units
Input Capacitance	$C_{ies}$		—	—	24	nf
Output Capacitance	$C_{oes}$	$V_{CE} = 10V, V_{GE} = 0V$	—	—	2.0	nf
Reverse Transfer Capacitance	$C_{res}$		—	—	0.45	nf
Inductive Load	Turn-on Delay Time	$V_{CC} = 600V, I_C = 150\text{A},$ $V_{GE1} = V_{GE2} = 15V, R_G = 2.1\Omega,$	—	—	150	ns
	Rise Time		$t_r$	—	—	80
Switch Time	Turn-off Delay Time	Inductive Load Switching Operation,	—	—	400	ns
	Fall Time		$t_f$	—	—	150
Diode Reverse Recovery Time**	$t_{rr}$	$I_E = 150\text{A}$	—	—	150	ns
Diode Reverse Recovery Charge**	$Q_{rr}$		—	7.5	—	$\mu\text{C}$

\* Pulse width and repetition rate should be such that device junction temperature ( $T_j$ ) does not exceed  $T_{j(max)}$  rating.

\*\*Represents characteristics of the anti-parallel, emitter-to-collector free-wheel diode (FWDi).

**CM150DU-24NFH**  
**Dual IGBTMOD™ NFH-Series Module**  
 150 Amperes/1200 Volts

**Thermal and Mechanical Characteristics,  $T_j = 25\text{ }^\circ\text{C}$  unless otherwise specified**

Characteristics	Symbol	Test Conditions	Min.	Typ.	Max.	Units
Thermal Resistance, Junction to Case	$R_{th(j-c)Q}$	Per IGBT 1/2 Module, $T_C$ Reference Point per Outline Drawing	—	—	0.19	$^\circ\text{C/W}$
Thermal Resistance, Junction to Case	$R_{th(j-c)D}$	Per FWDi 1/2 Module, $T_C$ Reference Point per Outline Drawing	—	—	0.35	$^\circ\text{C/W}$
Thermal Resistance, Junction to Case	$R_{th(j-c)'Q}$	Per IGBT 1/2 Module, $T_C$ Reference Point Under Chips	—	—	0.13	$^\circ\text{C/W}$
Thermal Resistance, Junction to Case	$R_{th(j-c)'D}$	Per FWDi 1/2 Module, $T_C$ Reference Point per Outline Drawing	—	—	0.21	$^\circ\text{C/W}$
Contact Thermal Resistance	$R_{th(c-f)}$	Per 1/2 Module, Thermal Grease Applied	—	0.07	—	$^\circ\text{C/W}$
External Gate Resistance	$R_G$		2.1	—	21	$\Omega$

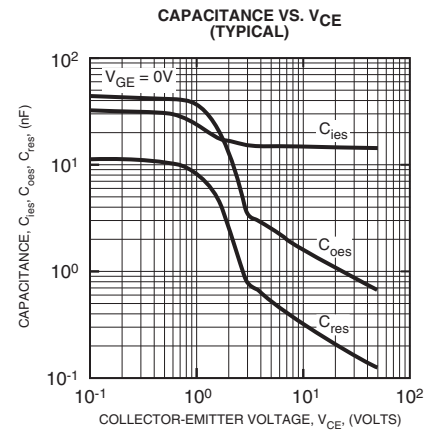
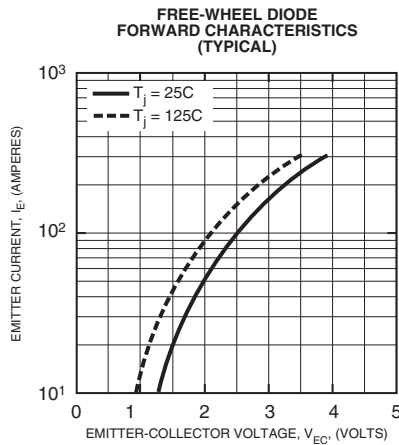
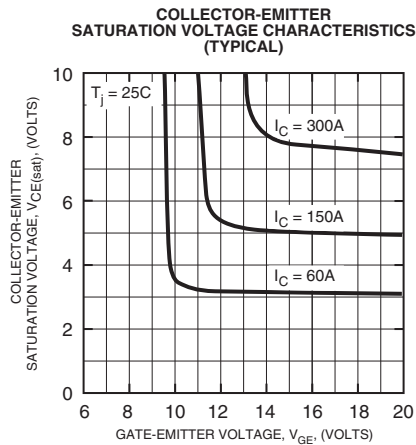
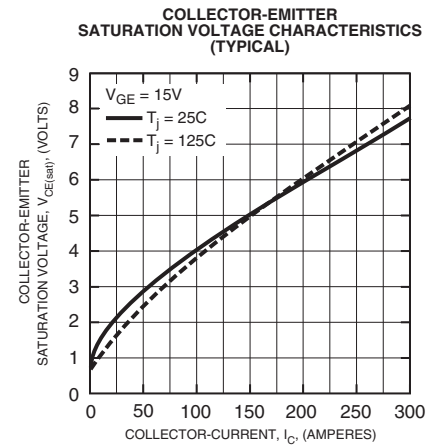
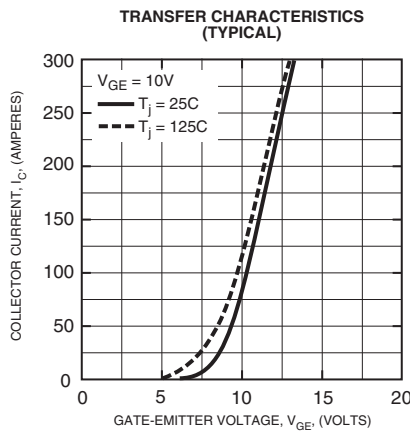
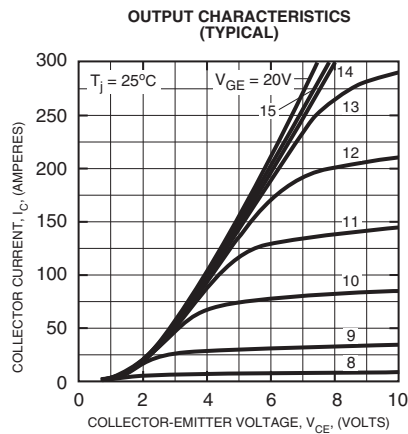

**CM150DU-24NFH**  
**Dual IGBTMOD™ NFH-Series Module**  
 150 Amperes/1200 Volts

