

**Chopper IGBT
 NX-Series Module
 200 Amperes/1200 Volts**

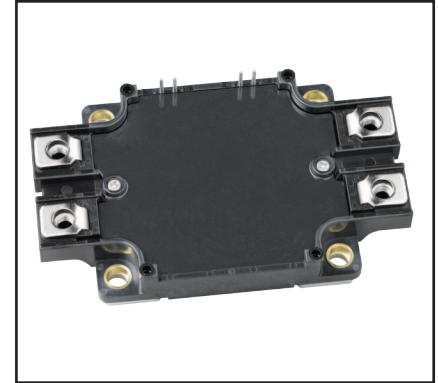
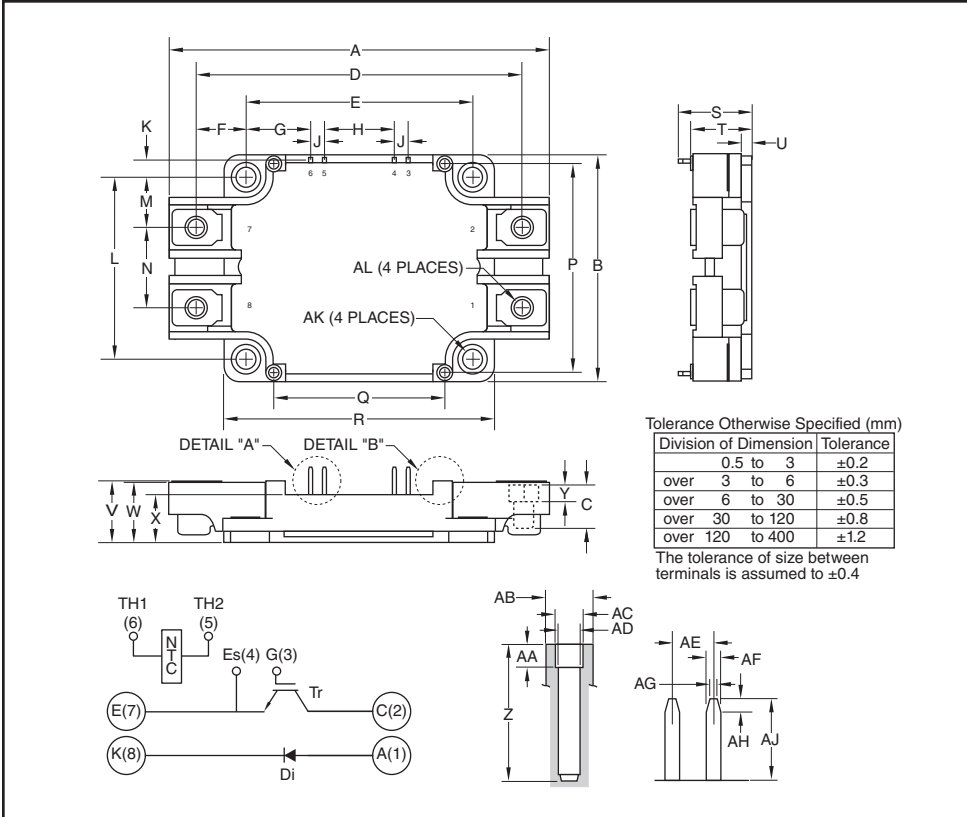

Description:

Powerex IGBT Modules are designed for use in switching applications. Each module consists of one IGBT Transistor and one super-fast recovery diode. All components and interconnects are isolated from the heat sinking baseplate, offering simplified system assembly and thermal management.

Features:

- Low Drive Power
- Low $V_{CE(sat)}$
- Discrete Super-Fast Recovery Clamp Diode
- RoHS Compliant
- Isolated Copper Baseplate for Easy Heat Sinking

Applications:

- DC/DC Converter
- DC Motor Control
- Brake Circuit

Ordering Information:

Example: Select the complete module number you desire from the table below -i.e. CM200EXS-24S is a 1200V (V_{CES}), 200 Ampere Chopper IGBT Power Module.

Type	Current Rating Amperes	V_{CES} Volts (x 50)
CM	200	24

Outline Drawing and Circuit Diagram

Dimensions	Inches	Millimeters
A	4.09	104.0
B	2.44	62.0
C	0.47	11.9
D	3.5	89.0
E	2.44	62.0
F	0.53	13.5
G	0.69	17.66
H	0.75	19.05
J	0.14	3.8
K	0.16	4.2
L	1.97	50.0
M	0.55	14.0
N	0.87	22.0
P	2.26	57.5
Q	1.83	46.5
R	2.9	73.71
S	0.8	20.5
T	0.67	17.0

Dimensions	Inches	Millimeters
U	0.27	7.0
V	0.67	17.0
W	0.64	16.4
X	0.51	13.1
Y	0.17	4.4
Z	0.49	12.5
AA	0.12	3.0
AB	0.17 Dia.	4.3 Dia.
AC	0.102 Dia.	2.6 Dia.
AD	0.088 Dia.	2.25 Dia.
AE	0.15	3.81
AF	0.045	1.15
AG	0.025	0.65
AH	0.05	1.2
AJ	0.29	7.4
AK	0.21 Dia.	5.5 Dia.
AL	M5	M5

CM200EXS-24S
Chopper IGBT NX-Series Module
 200 Amperes/1200 Volts

Absolute Maximum Ratings, $T_j = 25^\circ\text{C}$ unless otherwise specified

Characteristics	Symbol	Rating	Units
Collector-Emitter Voltage ($V_{GE} = 0\text{V}$)	V_{CES}	1200	Volts
Gate-Emitter Voltage ($V_{CE} = 0\text{V}$)	V_{GES}	± 20	Volts
Collector Current (DC, $T_C = 119^\circ\text{C}$) ^{*2}	I_C	200	Amperes
Collector Current (Pulse, Repetitive) ^{*3}	I_{CRM}	400	Amperes
Total Power Dissipation ($T_C = 25^\circ\text{C}$) ^{*2,*4}	P_{tot}	1500	Watts
Repetitive Peak Reverse Voltage (Clamp Diode Part, $V_{GE} = 0\text{V}$)	V_{RRM}	1200	Volts
Forward Current (Clamp Diode Part, $T_C = 25^\circ\text{C}$) ^{*2,*4}	I_F^{*1}	200	Amperes
Forward Current (Clamp Diode Part, Pulse, Repetitive) ^{*3}	I_{FRM}^{*1}	400	Amperes
Maximum Junction Temperature	$T_{j(max)}$	+175	$^\circ\text{C}$
Operating Junction Temperature	$T_{j(op)}$	-40 to +150	$^\circ\text{C}$
Storage Temperature	T_{stg}	-40 to +125	$^\circ\text{C}$
Case Temperature	T_C	-40 to +125	$^\circ\text{C}$
Isolation Voltage (Terminals to Baseplate, $f = 60\text{Hz}$, AC 1 minute)	V_{ISO}	2500	Volts

*1 Represent ratings and characteristics of the anti-parallel, emitter-to-collector clamp diode.

*2 Case temperature (T_C) and heatsink temperature (T_s) is measured on the surface (mounting side) of the baseplate and the heatsink side just under the chips. Refer to the figure to the right for chip location.

*3 Pulse width and repetition rate should be such that device junction temperature (T_j) does not exceed $T_{j(max)}$ rating. The heatsink thermal resistance should be measured just under the chips.

*4 Junction temperature (T_j) should not increase beyond maximum junction temperature ($T_{j(max)}$) rating.

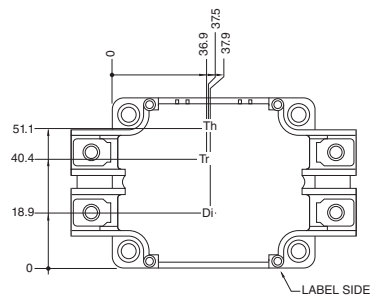

Each mark points to the center position of each chip.
 Tr: IGBT Di: Clamp Diode Th: NTC Thermistor

CM200EXS-24S
Chopper IGBT NX-Series Module
 200 Amperes/1200 Volts

Electrical Characteristics, $T_j = 25^\circ\text{C}$ unless otherwise specified

Characteristics	Symbol	Test Conditions	Min.	Typ.	Max.	Units
Collector-Emitter Cutoff Current	I_{CES}	$V_{CE} = V_{CES}, V_{GE} = 0V$	—	—	1	mA
Gate-Emitter Leakage Current	I_{GES}	$\pm V_{GE} = V_{GES}, V_{CE} = 0V$	—	—	0.5	μA
Gate-Emitter Threshold Voltage	$V_{GE(th)}$	$I_C = 20\text{mA}, V_{CE} = 10V$	5.4	6	6.6	Volts
Collector-Emitter Saturation Voltage (Terminal)	$V_{CE(sat)}$	$I_C = 200\text{A}, V_{GE} = 15V, T_j = 25^\circ\text{C}^{*6}$	—	1.80	2.25	Volts
		$I_C = 200\text{A}, V_{GE} = 15V, T_j = 125^\circ\text{C}^{*6}$	—	2.00	—	Volts
		$I_C = 200\text{A}, V_{GE} = 15V, T_j = 150^\circ\text{C}^{*6}$	—	2.05	—	Volts
Collector-Emitter Saturation Voltage (Chip)	$V_{CE(sat)}$	$I_C = 200\text{A}, V_{GE} = 15V, T_j = 25^\circ\text{C}^{*6}$	—	1.70	2.15	Volts
		$I_C = 200\text{A}, V_{GE} = 15V, T_j = 125^\circ\text{C}^{*6}$	—	1.90	—	Volts
		$I_C = 200\text{A}, V_{GE} = 15V, T_j = 150^\circ\text{C}^{*6}$	—	1.95	—	Volts
Input Capacitance	C_{ies}		—	—	20	nF
Output Capacitance	C_{oes}	$V_{CE} = 10V, V_{GE} = 0V$	—	—	4.0	nF
Reverse Transfer Capacitance	C_{res}		—	—	0.33	nF
Gate Charge	Q_G	$V_{CC} = 600V, I_C = 200\text{A}, V_{GE} = 15V$	—	466	—	nC
Turn-on Delay Time	$t_{d(on)}$		—	—	800	ns
Rise Time	t_r	$V_{CC} = 600V, I_C = 200\text{A}, V_{GE} = \pm 15V,$	—	—	200	ns
Turn-off Delay Time	$t_{d(off)}$	$R_G = 0\Omega, \text{ Inductive Load}$	—	—	600	ns
Fall Time	t_f		—	—	300	ns
Repetitive Peak Reverse Current	I_{RRM}	$V_R = V_{RRM}$	—	—	1	mA
Forward Voltage Drop	V_F^{*1}	$I_F = 200\text{A}, V_{GE} = 0V, T_j = 25^\circ\text{C}^{*6}$	—	1.80	2.25	Volts
Clamp Di Part (Terminal)		$I_F = 200\text{A}, V_{GE} = 0V, T_j = 125^\circ\text{C}^{*6}$	—	1.80	—	Volts
		$I_F = 200\text{A}, V_{GE} = 0V, T_j = 150^\circ\text{C}^{*6}$	—	1.80	—	Volts
Forward Voltage Drop	V_F^{*1}	$I_F = 200\text{A}, V_{GE} = 0V, T_j = 25^\circ\text{C}^{*6}$	—	1.70	2.15	Volts
Clamp Di Part (Chip)		$I_F = 200\text{A}, V_{GE} = 0V, T_j = 125^\circ\text{C}^{*6}$	—	1.70	—	Volts
		$I_F = 200\text{A}, V_{GE} = 0V, T_j = 150^\circ\text{C}^{*6}$	—	1.70	—	Volts
Reverse Recovery Time	t_{rr}^{*1}	$V_{CC} = 600V, I_F = 200\text{A}, V_{GE} = \pm 15V$	—	—	300	ns
Reverse Recovery Charge	Q_{rr}^{*1}	$R_G = 0\Omega, \text{ Inductive Load, Clamp Di Part}$	—	10.7	—	μC
Turn-on Switching Energy per Pulse	E_{on}	$V_{CC} = 600V, I_C = I_F = 200\text{A},$	—	30.7	—	mJ
Turn-off Switching Energy per Pulse	E_{off}	$V_{GE} = \pm 15V, R_G = 0\Omega, T_j = 150^\circ\text{C},$	—	21.5	—	mJ
Reverse Recovery Energy per Pulse	E_{rr}^{*1}	Inductive Load, Clamp Di Part	—	14.2	—	mJ
Internal Lead Resistance	$R_{CC} + EE'$	Main Terminals-Chip, Per Switch, $T_C = 25^\circ\text{C}^{*2}$	—	—	—	m Ω
Internal Gate Resistance	r_g		—	9.8	—	Ω

*1 Represent ratings and characteristics of the anti-parallel, emitter-to-collector clamp diode.

*2 Case temperature (T_C) and heatsink temperature (T_S) is measured on the surface (mounting side) of the baseplate and the heatsink side just under the chips. Refer to the figure to the right for chip location.

The heatsink thermal resistance should be measured just under the chips.

*5 Pulse width and repetition rate should be such as to cause negligible temperature rise.

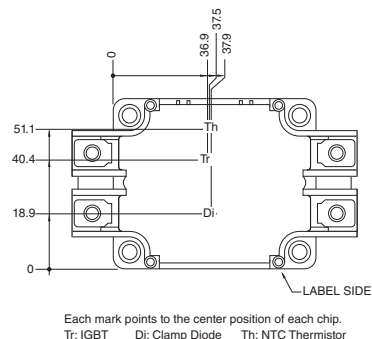

CM200EXS-24S
Chopper IGBT NX-Series Module
 200 Amperes/1200 Volts

Electrical Characteristics, $T_j = 25^\circ\text{C}$ unless otherwise specified (continued)

NTC Thermistor Part

Characteristics	Symbol	Test Conditions	Min.	Typ.	Max.	Units
Zero Power Resistance	R_{25}	$T_C = 25^\circ\text{C}^{*2}$	4.85	5.00	5.15	k Ω
Deviation of Resistance	$\Delta R/R$	$T_C = 100^\circ\text{C}$, $R_{100} = 493\Omega$	-7.3	—	+7.8	%
B Constant	$B_{(25/50)}$	Approximate by Equation ^{*8}	—	3375	—	K
Power Dissipation	P_{25}	$T_C = 25^\circ\text{C}^{*2}$	—	—	10	mW

Thermal Resistance Characteristics

Characteristics	Symbol	Test Conditions	Min.	Typ.	Max.	Units
Thermal Resistance, Junction to Case ^{*2}	$R_{th(j-c)Q}$	Per IGBT	—	—	0.10	K/W
Thermal Resistance, Junction to Case ^{*2}	$R_{th(j-c)D}$	Per Clamp Diode	—	—	0.19	K/W
Contact Thermal Resistance, Case to Heatsink ^{*2}	$R_{th(c-f)}$	Thermal Grease Applied (Per 1 Module) ^{*7}	—	25	—	K/kW

Mechanical Characteristics

Characteristics	Symbol	Test Conditions	Min.	Typ.	Max.	Units
Mounting Torque	M_t	Main Terminals, M5 Screw	22	27	31	in-lb
	M_s	Mounting to Heatsink, M5 Screw	22	27	31	in-lb
Creepage Distance	d_s	Terminal to Terminal	20	—	—	mm
		Terminal to Baseplate	17	—	—	mm
Clearance	d_a	Terminal to Terminal	12	—	—	mm
		Terminal to Baseplate	10	—	—	mm
Weight	m		—	210	—	Grams
Flatness of Baseplate	e_c	On Centerline X, Y ^{*5}	-100	—	+100	μm

Recommended Operating Conditions, $T_a = 25^\circ\text{C}$

Characteristics	Symbol	Test Conditions	Min.	Typ.	Max.	Units
(DC) Supply Voltage	V_{CC}	Applied Across P-N	—	600	850	Volts
Gate-Emitter Drive Voltage	$V_{GE(on)}$	Applied Across G-E	13.5	15.0	16.5	Volts
External Gate Resistance	R_G		0	—	30	Ω

^{*2} Case temperature (T_C) and heatsink temperature (T_S) is measured on the surface (mounting side) of the baseplate and the heatsink side just under the chips. Refer to the figure to the right for chip location. The heatsink thermal resistance should be measured just under the chips.

^{*5} Baseplate (mounting side) flatness measurement points (X, Y) are shown in the figure below.

^{*7} Typical value is measured by using thermally conductive grease of $\lambda = 0.9$ [W/(m • K)].

$$^*8 \ B_{(25/50)} = \ln\left(\frac{R_{25}}{R_{50}}\right) / \left(\frac{1}{T_{25}} - \frac{1}{T_{50}}\right)$$

R_{25} ; Resistance at Absolute Temperature T_{25} [K]; $T_{25} = 25$ [$^\circ\text{C}$] + 273.15 = 298.15 [K]
 R_{50} ; Resistance at Absolute Temperature T_{50} [K]; $T_{50} = 50$ [$^\circ\text{C}$] + 273.15 = 323.15 [K]

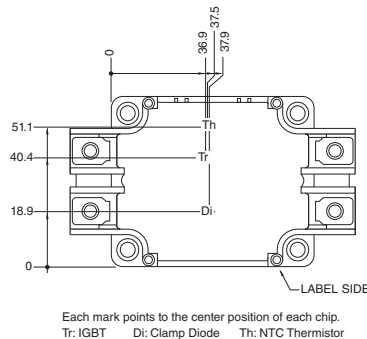
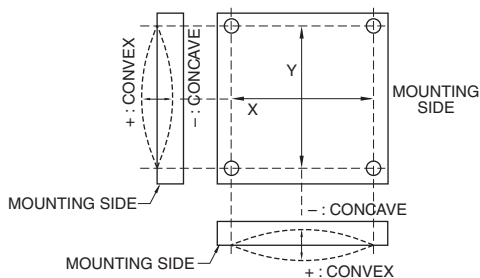

CM200EXS-24S
Chopper IGBT NX-Series Module
 200 Amperes/1200 Volts

OUTPUT CHARACTERISTICS (CHIP - TYPICAL)

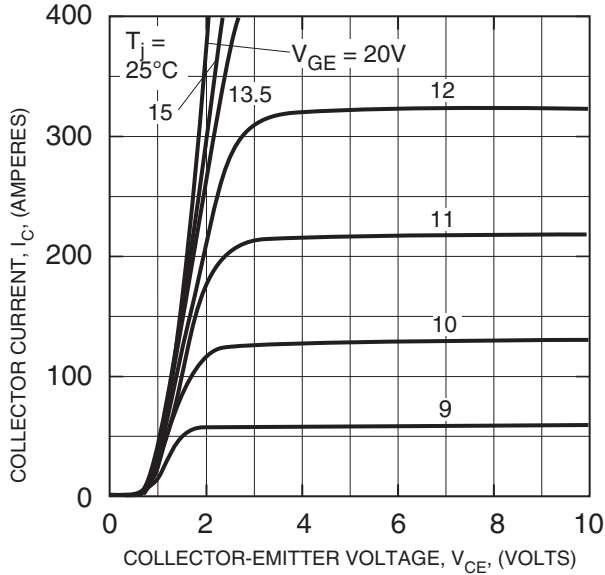

COLLECTOR-EMITTER SATURATION VOLTAGE CHARACTERISTICS (CHIP - TYPICAL)

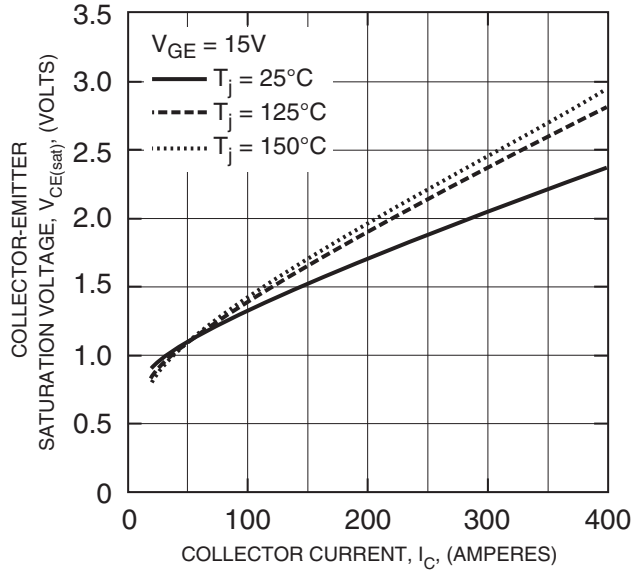

COLLECTOR-EMITTER SATURATION VOLTAGE CHARACTERISTICS (CHIP - TYPICAL)

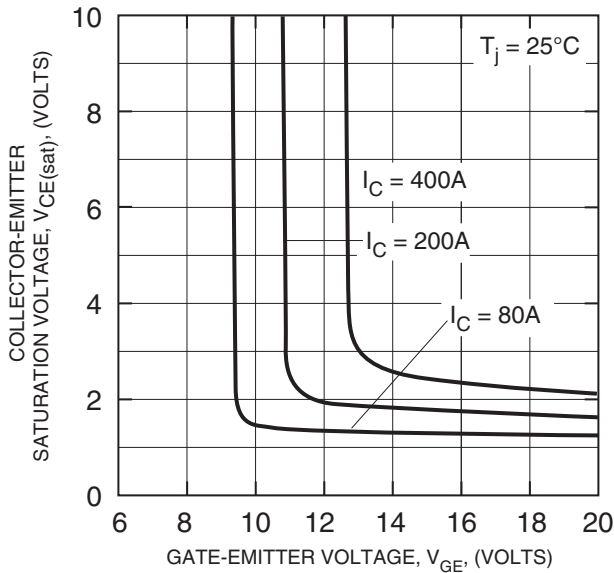

FREE-WHEEL DIODE FORWARD CHARACTERISTICS (CHIP - TYPICAL)

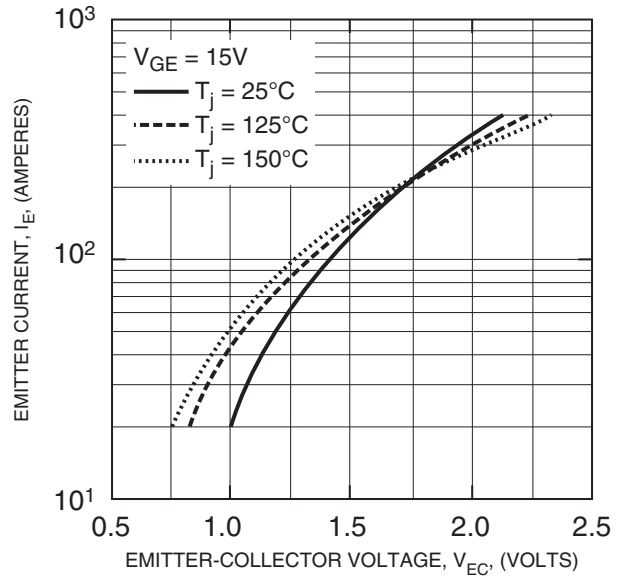

CM200EXS-24S
Chopper IGBT NX-Series Module
 200 Amperes/1200 Volts

CAPACITANCE VS. V_{CE}
(TYPICAL)

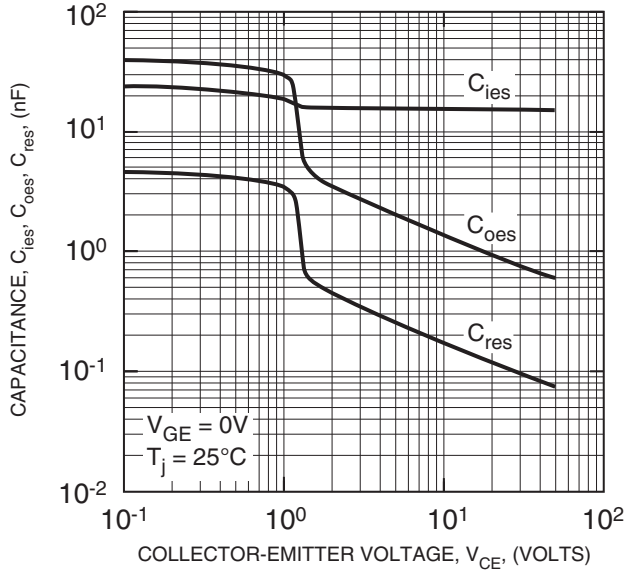

HALF-BRIDGE SWITCHING CHARACTERISTICS
(TYPICAL)

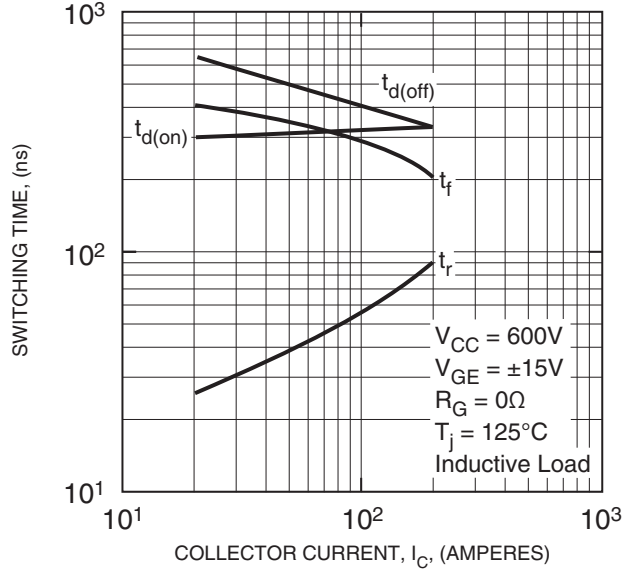

HALF-BRIDGE SWITCHING CHARACTERISTICS
(TYPICAL)

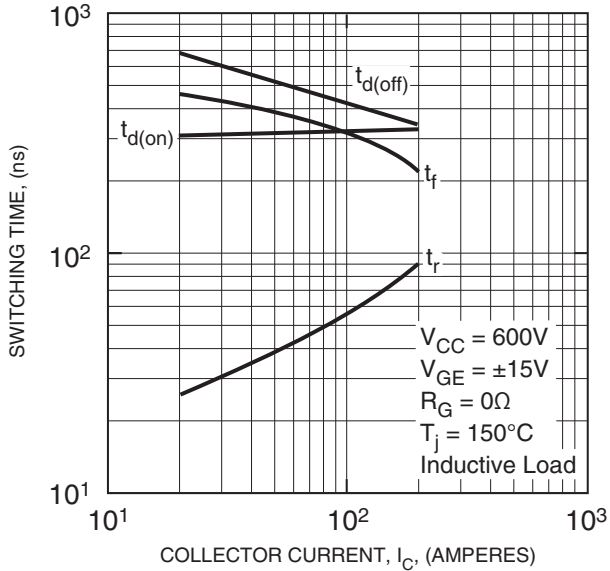

SWITCHING TIME VS. GATE RESISTANCE
(TYPICAL)

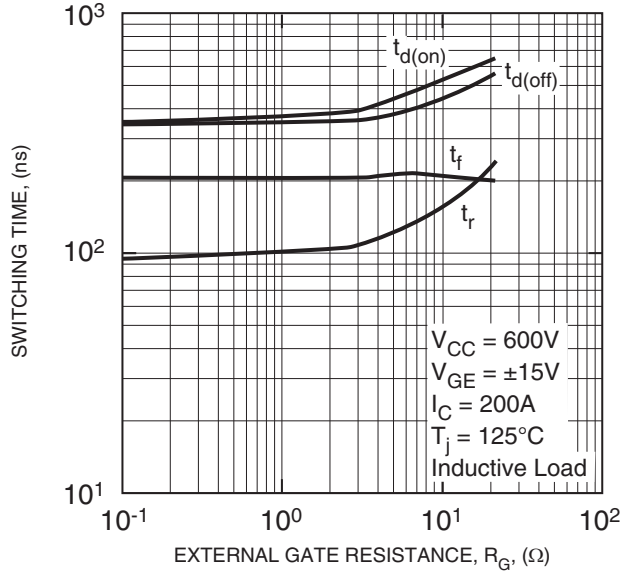

CM200EXS-24S
Chopper IGBT NX-Series Module
 200 Amperes/1200 Volts

SWITCHING TIME VS. GATE RESISTANCE (TYPICAL)

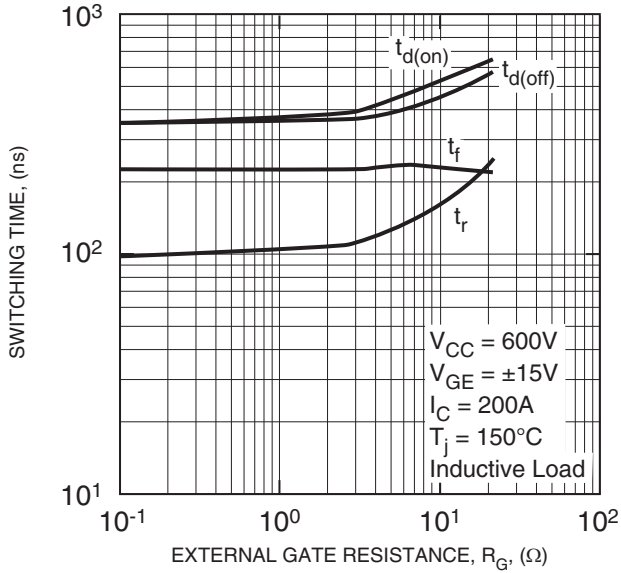

REVERSE RECOVERY CHARACTERISTICS (TYPICAL)

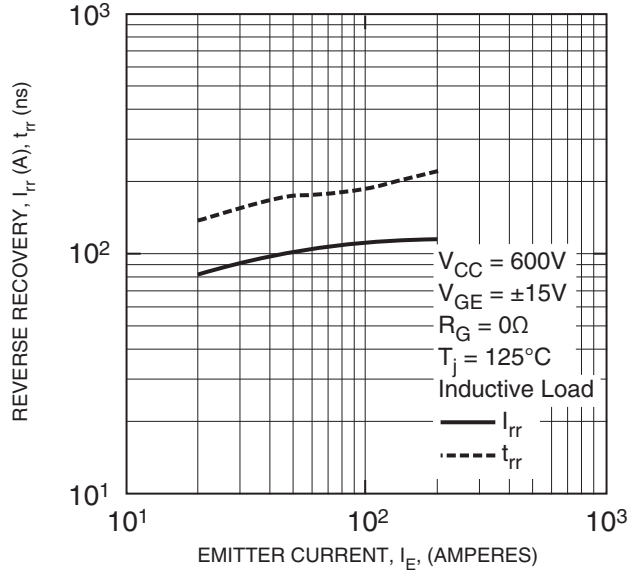

REVERSE RECOVERY CHARACTERISTICS (TYPICAL)

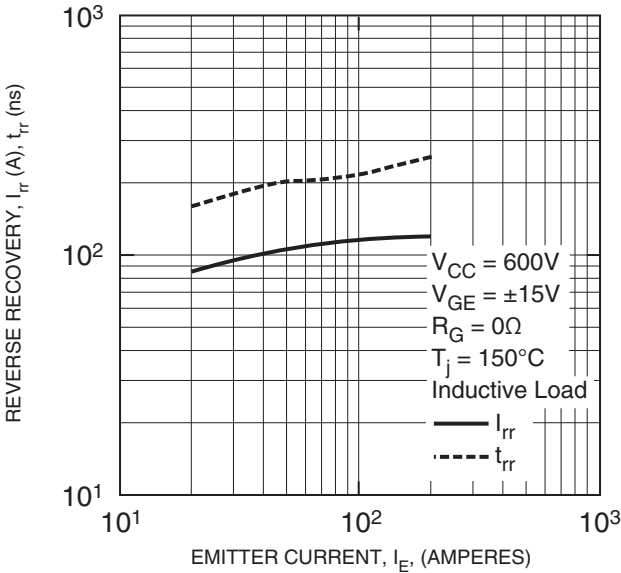

GATE CHARGE VS. V_{GE}

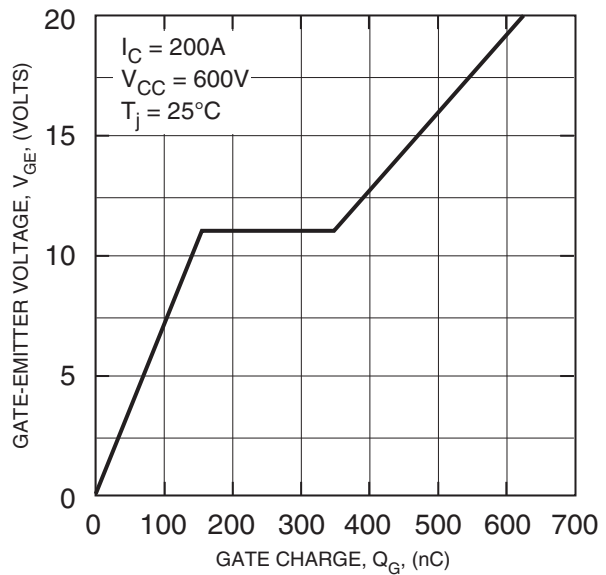

CM200EXS-24S
Chopper IGBT NX-Series Module
 200 Amperes/1200 Volts

HALF-BRIDGE SWITCHING CHARACTERISTICS (TYPICAL)

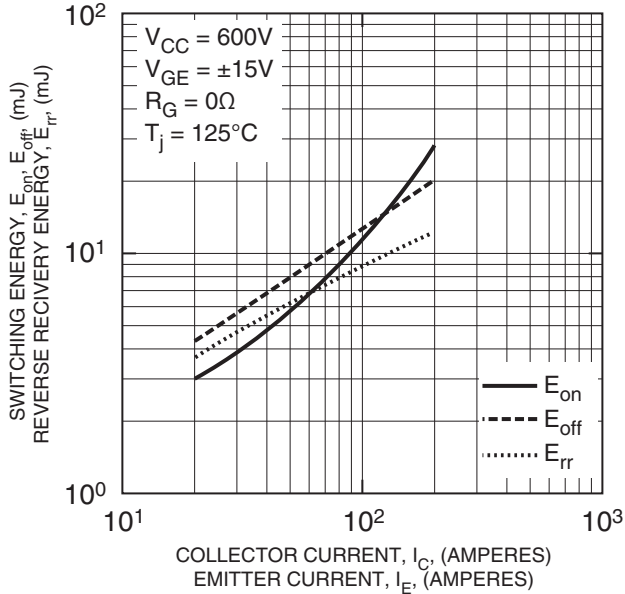

HALF-BRIDGE SWITCHING CHARACTERISTICS (TYPICAL)

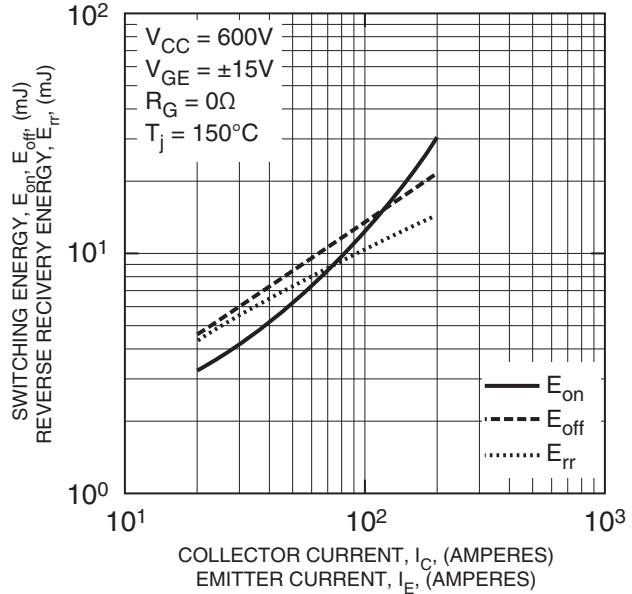

HALF-BRIDGE SWITCHING CHARACTERISTICS (TYPICAL)

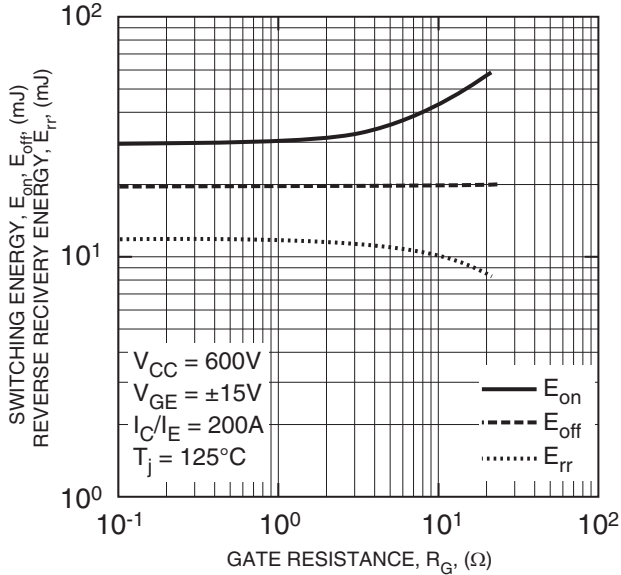

HALF-BRIDGE SWITCHING CHARACTERISTICS (TYPICAL)

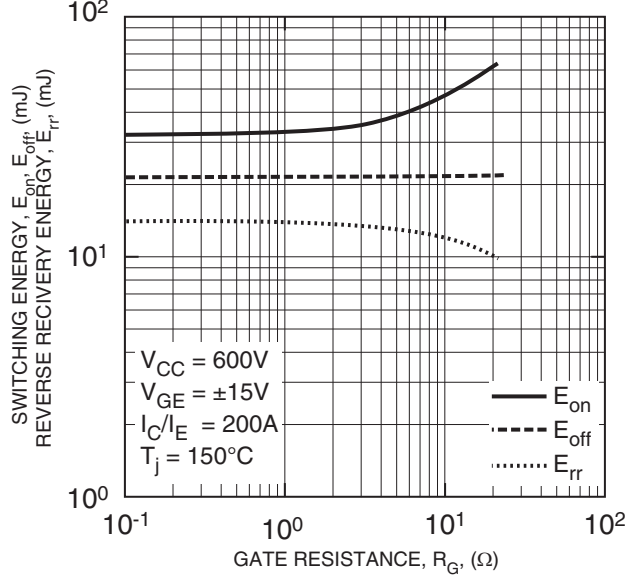

CM200EXS-24S
Chopper IGBT NX-Series Module
 200 Amperes/1200 Volts

