



Model Number AC-50CD350UV

Type: Constant Current LED Driver
 Input Voltage: 120-277V
 Input Frequency: 50/60Hz



ELECTRICAL SPECIFICATIONS:

Output Power Max	Input Power	Input Current	Minimum PF (full load)	Max. THD (full load)	Output Voltage	Output Current	T case Max.	Min. Starting Temp.	Efficiency Up To	Dimming Protocol	Dimming Range	IP Rating
50W	60W @ 120V 59W @ 277V	0.5A @ 120V 0.22A @ 277V	>0.95	<20%	100-143V	350mA±5%	90°C	-40°C	83%	0 to 10V	10 to 100%	66

WIRING:

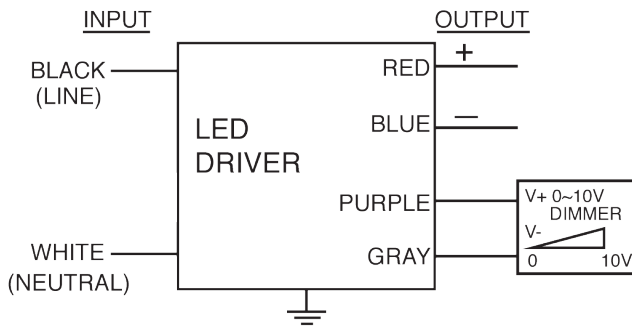

Lead Lengths					
Black	5.9"	Blue	5.9"	Purple	5.9"
White	5.9"	Red	5.9"	Gray	5.9"

PHYSICAL:



Dimensions	
Length	6.5"
Width	2.9"
Height	1.18"
Mounting Length	5.9"
Weight	0.83 lbs.
Case Qty.	30 pcs.

SAFETY & PERFORMANCE:

- UL and cUL Recognized
- UL Outdoor Type I
- Class A sound rating
- No PCBs
- IP Rating 66
- Open/Short Circuit Protection
- LED driver has a life expectancy of 50,000 hours at Tcase of ≤75°C
- LED driver has a life expectancy of 100,000 hours at Tcase of ≤65°C
- Warranty: 5 yrs based on max case temp of <75°C; 3 yrs based on max case temp of 90°C*
- Input/Output Isolation
- FCC Title 47 CFR Part 15
- Surge Protection (2 KV)

INSTALLATION:

- LED drivers shall be installed inside electrical enclosures
- 18 AWG 600V/105C tinned strand copper lead-wires are required to use in installation
- Max Remote installation distance is 18 ft
- LED driver cases should be grounded



*A.C.E. warrants to the purchaser that each LED Driver will be free from defects in material or workmanship for a period of 5 years when operated at max case temp of up to <75°C; 3 years from date of manufacture when operated at a max case temp of up to 90°C when properly installed and under normal conditions of use. See www.aceleds.com for complete warranty policy.

3401 Avenue D, Arlington, TX 76011 • 800-375-6355 • www.aceleds.com

Data is based upon tests performed by AC Electronics in a controlled environment and representative performance. Actual performance can vary depending on operating conditions. Specifications are subject to change without notice. All specifications are nominal unless otherwise noted.