

UNCONTROLLED DOCUMENT

PART NUMBER  
SML-LX15SGC-RP-TR

REV.

D

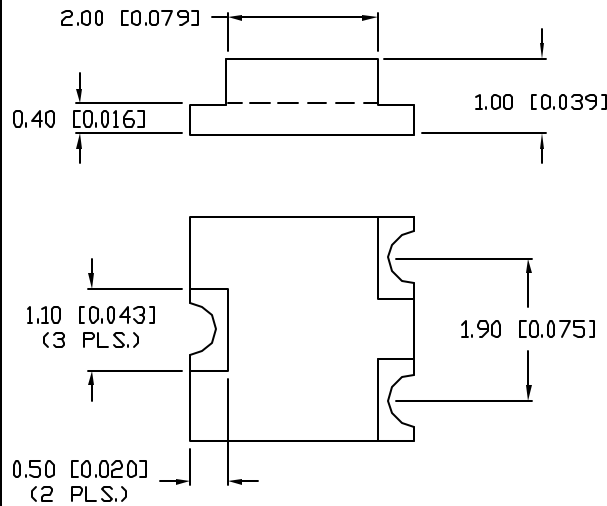
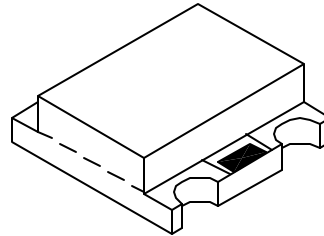
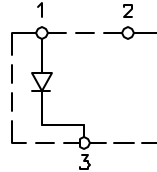
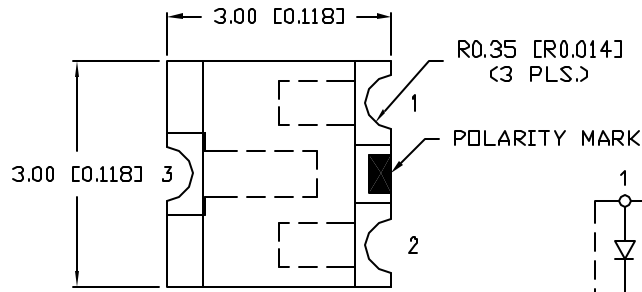

LEAD FREE REFLOW PROFILE

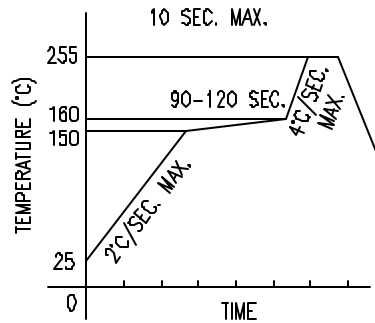

TOTAL TIME ABOVE 220°C IS 60 SECONDS MAX. OPERATING, STORAGE TEMP.

RECOMMENDED PAD LAYOUT

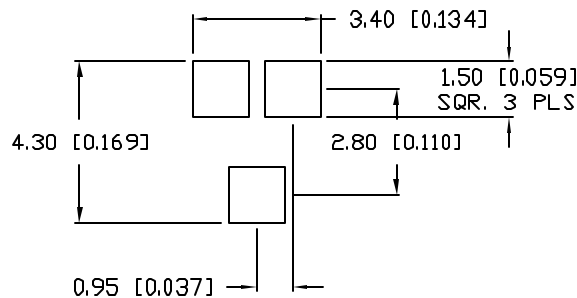

ELECTRO-OPTICAL CHARACTERISTICS  $T_A=25^\circ\text{C}$   $I_f=20\text{mA}$

PARAMETER	MIN	TYP	MAX	UNITS	TEST COND
PEAK WAVELENGTH		565		nm	
FORWARD VOLTAGE		2.2	2.6	$V_f$	
REVERSE VOLTAGE	5.0			$V_r$	$I_f=100\mu\text{A}$
AXIAL INTENSITY		15		mcad	$I_f=20\text{mA}$
VIEWING ANGLE		140		2x theta	
EMITTED COLOR:	GREEN				
EPOXY LENS FINISH:	WATER CLEAR				

LIMITS OF SAFE OPERATION AT 25°C

PARAMETER	MAX	UNITS
PEAK FORWARD CURRENT*	160	mA
STEADY CURRENT	25	mA
POWER DISSIPATION	100	mW
DERATE FROM 25°C	-1.2	mW/°C
OPERATING, STORAGE TEMP.	-40 TO +85	°C

\*  $t < 10\mu\text{s}$

TAPE SPEC DETAIL

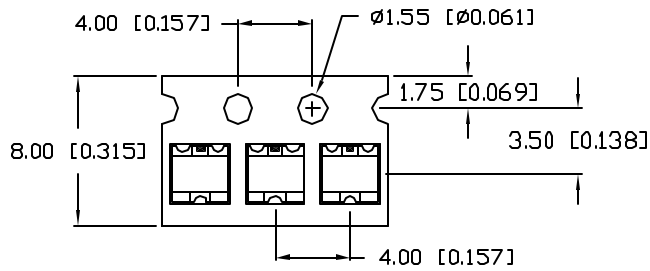

TAPE FEED DIRECTION

NOTES:

1. THE POLARITY MARK IS ORIENTED TOWARDS THE TAPE SPROCKET HOLE.

CAUTION: MOISTURE SENSITIVE DEVICE  
PER JEDEC LEVEL 4 STANDARDS

UNCONTROLLED DOCUMENT

\*UNLESS OTHERWISE SPECIFIED TOLERANCES PER DECIMAL PRECISION ARE: X=±1 (+0.039), XX=±0.5 (+0.020), XXX=±0.25 (+0.010), XXXX=±0.127 (+0.005), LEAD SIZE=±0.05 (0.002), LEAD LENGTH=±0.75 (+0.030), MIN.= +DECIMAL PRECISION MAX.= +0.00 -DECIMAL PRECISION

REV.

D

PART NUMBER

SML-LX15SGC-RP-TR

SOT-23 REPLACEMENT, SURFACE MOUNT LED,  
565nm SUPER GREEN LED, REVERSE POLARITY,  
WATER CLEAR LENS, TAPE AND REEL

CONFIDENTIAL INFORMATION

THE INFORMATION CONTAINED IN THIS DOCUMENT IS THE PROPERTY OF LUMEX INC. EXCEPT AS SPECIFICALLY AUTHORIZED IN WRITING BY LUMEX INC., THE HOLDER OF THIS DOCUMENT SHALL KEEP ALL INFORMATION CONTAINED HEREIN CONFIDENTIAL AND SHALL PROTECT SAME IN WHOLE OR IN PART FROM DISCLOSURE AND DISSEMINATION TO ALL THIRD PARTIES.

RELIABILITY NOTE

OUR MANY YEARS OF EXPERIENCE DATA ACCUMULATION INDICATE THAT SOLDER HEAT IS A MAJOR CAUSE OF EARLY AND FUTURE FAILURE. PLEASE PAY ATTENTION TO YOUR SOLDERING PROCESS.



290 E. HELEN ROAD  
PALATINE, IL 60067-6976  
PHONE: +1.847.359.2790  
US WEB: www.lumex.com  
TW WEB: www.lumex.com.tw

DRAWN BY:

jc

CHECKED BY:

APPROVED BY:

DATE: 11.28.06

PAGE: 1 OF 1

SCALE: N/A