

Screw Connection Single Level

- **Plastic Body:** Polyamide 6.6
- **Internal Bus:** Nickel-plated brass
- **Clamp:** Hardened steel, electro-plated with zinc yellow-chromated
- **Screws:** Steel, zinc-plated and yellow-chromated
- **Marking:** 4 slots on both sides
- **Tracking Resistance:**
IEC 112: CTI > 600
VDE 0303: KB > 600

6102000 2.5/5 Feed Through

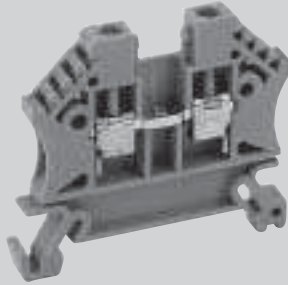

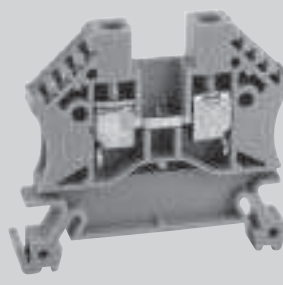

6104000 4/6 Feed Through

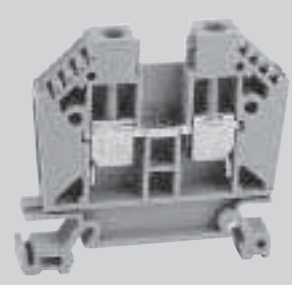

6106000 6/8 Feed Through



Dimensions	44 mm (L) x 36 mm (H) x 5 mm (W)	44 mm (L) x 36 mm (H) x 6 mm (W)	50 mm (L) x 44 mm (H) x 7 mm (W)
Opening	3.6 x 2.6 mm	4 x 3.3 mm	5 x 4 mm
Stripping Length	10 mm	10 mm	12 mm
Screw Thread	M 2.6	M 3	M 3.5
Central Thread	M 2.5	M 3	M 3
Connecting Capacity	Solid conductors mm ² 0.5-4 Stranded conductors mm ² 0.5-2.5	Solid conductors mm ² 0.5-4 Stranded conductors mm ² 0.5-4	Solid conductors mm ² 0.5-10 Stranded conductors mm ² 0.5-6
Conductors with Ferrules	DIN 46288 / 1 mm ² 0.5-2.5	DIN 46288 / 1 mm ² 0.5-4	DIN 46288 / 1 mm ² 0.5-6
Number of Connectable Conductors	2 x 1.5 mm ² 4 x 1.0 mm ²	4 x 1.5 mm ²	2 x 4 mm ²
Approvals			
Wire Range	24-12 AWG 24-12 AWG 2.5 mm ²	24-10 AWG 24-10 AWG 4 mm ²	22-8 AWG 22-8 AWG 10 mm ²
Voltage Rating	600V 600V 800V	600V 600V 800V	600V 600V 800V
Current Rating	20A 20A 20A	30A 30A 32A	50A 50A 41A
Tightening Torque	Max. 0.5 Nm	Max. 0.6 Nm	Max. 1.2 Nm
Gauges	A3	A4	A5
ACCESSORIES	Cat. No.	Cat. No.	Cat. No.
Available Colors	6102000 – Gray 6102001 – Blue 6102002 – Black 6102003 – Brown 6102004 – Yellow-Green 6102005 – Green 6102006 – Yellow 6102007 – Orange 6102008 – Red 6102009 – White	6104000 – Gray 6104001 – Blue 6104002 – Black 6104003 – Brown 6104004 – Yellow-Green 6104005 – Green 6104006 – Yellow 6104007 – Orange 6104008 – Red 6104009 – White	6106000 – Gray 6106001 – Blue 6106004 – Yellow-Green 6106005 – Green 6106006 – Yellow 6106007 – Orange 6106008 – Red
End Plate Qty. pk. 10	6800010 – 44 mm (L) x 35 mm (H) x 1.5 mm (W)	6800010 – 44 mm (L) x 35 mm (H) x 1.5 mm (W)	6800011 – 50 mm (L) x 43 mm (H) x 1.5 mm (W)
Separator Qty. pk. 100	6800051 – 55 mm (L) x 44 mm (H) x 1.5 mm (W)	6800051 – 55 mm (L) x 44 mm (H) x 1.5 mm (W)	6800050 – 55 mm (L) x 49 mm (H) x 1.5 mm (W)
Cover Qty. pk. 100	6800075 – 47 mm (L) x 24.5 mm (H) x 4.8 mm (W)	6800076 – 47 mm (L) x 24.5 mm (H) x 5.8 mm (W)	6800077 – 53 mm (L) x 26 mm (H) x 6.8 mm (W)
Jumper-Bar Package	6800110 – .5M Jumper Bar	6800120 – .5M Jumper Bar	6800130 – .5M Jumper Bar
Jumpers 2 pole	6800102 – 100 pieces	6800112 – 100 pieces	6800122 – 100 pieces
3 pole	6800103 – 100 pieces	6800113 – 100 pieces	6800123 – 100 pieces
4 pole	6800104 – 100 pieces	6800114 – 100 pieces	6800124 – 100 pieces
End Bracket Qty. pk. 100	6804150 – 58 mm (L) x 36 mm (H) x 9 mm (W)	6804150 – 58 mm (L) x 36 mm (H) x 9 mm (W)	6804150 – 58 mm (L) x 36 mm (H) x 9 mm (W)
Test Plug Adapter (red)		6800501 – dia. 2.8 mm	6800501 – dia. 2.8 mm
Test Plug Adapter (black)		6800500 – dia. 2.8 mm	6800500 – dia. 2.8 mm

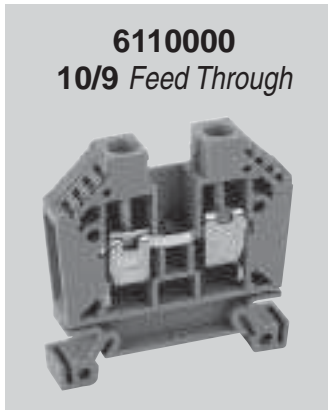

6110000
10/9 Feed Through

50 mm (L) x 44 mm (H) x 9 mm (W)
6 x 5.5 mm
12 mm
M 4
M 3
Solid conductors mm ² 1.5-16 Stranded conductors mm ² 1.5-10
DIN 46288 / 1 mm ² 1.5-10
2 x 6 mm ²

20-6 AWG	20-6 AWG	10 mm ²
600V	600V	800V
65A	65A	57A

Max 2.0 Nm
B6
Cat. No.

- 6110000 – Gray
- 6110001 – Blue
- 6110004 – Yellow-Green
- 6110005 – Green
- 6110006 – Yellow
- 6110007 – Orange



6116000
16-25/12 Feed Through

56 mm (L) x 49 mm (H) x 12 mm (W)
7 x 7.4 mm
14 mm
M 5
M 4
Solid conductors mm ² 1.5-25 Stranded conductors mm ² 1.5-10
DIN 46288 / 1 mm ² 1.5-25
2 x 10 mm ²

14-4 AWG	14-4 AWG	25 mm ²
600V	600V	800V
85A	85A	101A

Max 3.0 Nm
B7
Cat. No.

- 6116000 – Gray
- 6116001 – Blue
- 6116004 – Yellow-Green
- 6116006 – Yellow



6135000
35-50/16 Feed Through

62 mm (L) x 61 mm (H) x 16 mm (W)
11 x 10 mm
17 mm
M 6
M 4
Solid conductors mm ² 2.5-50 Stranded conductors mm ² 2.5-50
DIN 46288 / 1 mm ² 2.5-50
2 x 25 mm ²

14-1/0 AWG	14-1/0 AWG	50 mm ²
600V	600V	800V
130A	130A	150A

Max 5.0 Nm
B9
Cat. No.

- 6135000 – Gray
- 6135001 – Blue
- 6135004 – Yellow-Green
- 6135006 – Yellow
- 6135008 – Red

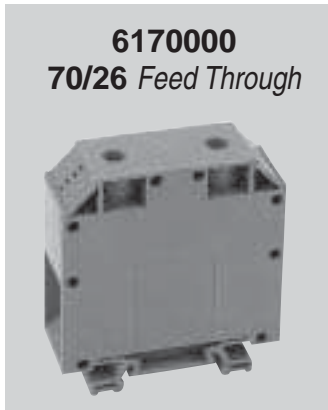

6170000
70/26 Feed Through

74 mm (L) x 75 mm (H) x 26 mm (W)
15.5 x 16.5 mm
26 mm
M 3
M 3
Solid conductors mm ² 16-70 Stranded conductors mm ² 16-70
DIN 46288 / 1 mm ² 16-70
2 x 50 mm ²

4-3/0 AWG	14-3/0 AWG	70 mm ²
600V	600V	800V
185A	185A	192A

Max 10.0 Nm
B11
Cat. No.

- 6170000 – Gray
- 6170001 – Blue
- 6170004 – Yellow-Green
- 6170006 – Yellow

6800011 – 50 mm (L) x 43 mm (H) x 1.5 mm (W)
6800050 – 55 mm (L) x 49 mm (H) x 1.5 mm (W)
6800077 – 53 mm (L) x 26 mm (H) x 6.8 mm (W)
6800140 – .5M Jumper Bar
6800132 – 100 pieces
6800133 – 100 pieces
6800134 – 100 pieces
6804150 – 58 mm (L) x 36 mm (H) x 9 mm (W)
6800501 – dia. 2.8 mm
6800500 – dia. 2.8 mm

6800012 – 44 mm (L) x 35 mm (H) x 1.5 mm (W)
6800078 – 59 mm (L) x 26 mm (H) x 11.5 mm (W)
6800150 – .5M Jumper Bar
6800142 – 100 pieces
6800143 – 100 pieces
6800144 – 100 pieces
6804150 – 58 mm (L) x 36 mm (H) x 9 mm (W)

6800013 – 62 mm (L) x 60 mm (H) x 1.5 mm (W)
6800079 – 59 mm (L) x 26 mm (H) x 15.5 mm (W)
6800160 – .5M Jumper Bar
6800152 – 100 pieces
6800153 – 100 pieces
6800154 – 100 pieces
6804150 – 58 mm (L) x 36 mm (H) x 9 mm (W)

6804150 – 58 mm (L) x 36 mm (H) x 9 mm (W)
--

Dimensions are in inches and millimeters unless otherwise specified. Values in parentheses are metric equivalents.

Screw Connection Single Level

- **Plastic Body:** Polyamide 6.6
- **Internal Bus:** Nickel-plated brass
- **Clamp:** Hardened steel, electro-plated with zinc yellow-chromated
- **Screws:** Steel, zinc-plated and yellow-chromated
- **Marking:** 4 slots on both sides
- **Tracking Resistance:**
IEC 112: CTI > 600
VDE 0303: KB > 600

6504000 4/15 Mini Feed Through

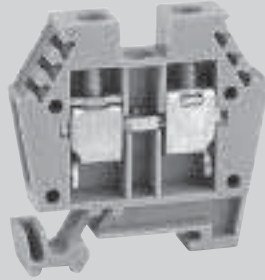

Screw Connection Dual Level

- **Plastic Body:** Polyamide 66.6 VO
- **Internal Bus:** Silver plated copper
- **Clamp:** Hardened steel, electro-plated with zinc yellow chromated
- **Screws:** Steel, zinc plated and yellow chromated
- **Marking:** 4 slots on both sides
- **Tracking Resistance:**
IEC 112: CTI > 600
VDE 0303: KB > 600

6204000 D 4-2/6 Feed Through

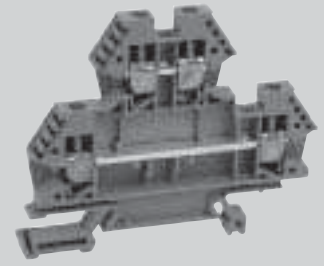

Dimensions	32 mm (L) x 28 mm (H) x 6 mm (W)			Dimensions	72 mm (L) x 55 mm (H) x 6 mm (W)		
Opening	4 x 3.3 mm			Opening	4 x 3.3 mm		
Stripping Length	10 mm			Stripping Length	10 mm		
Screw Thread	M 3			Terminal Screw	M 3		
Central Thread				Terminal Screw	M 3		
Connecting Capacity	Solid conductors mm ² 0.5-6 Stranded conductors mm ² 0.5-4			Connecting Capacity	Solid conductors mm ² 0.5-6 Stranded conductors mm ² 0.5-4		
Conductors with Ferrules	DIN 46288 / 1 mm ² 0.5-4			Conductors with Ferrules	DIN 46288 / 1 mm ² 0.5-4		
Number of Connectable Conductors	4 x 1.5 mm ²			Number of Connectable Conductors	4 x 1.5 mm ²		
Approvals				Approvals			
Wire Range	24-10 AWG	24-10 AWG	4 mm ²	Wire Range	24-10 AWG	24-10 AWG	4 mm ²
Voltage Rating	300V	300V	400V	Voltage Rating	600V	600V	800V
Current Rating	30A	30A	32A	Current Rating	30A	30A	32A
Tightening Torque	Max. 0.6 Nm			Tightening Torque	Max. 0.6 Nm		
Gauges	A4			Gauges	A4		
ACCESSORIES	Cat. No.			ACCESSORIES	Cat. No.		
Available Colors	6504000 – Gray 6504001 – Blue 6504002 – Black 6504004 – Yellow-Green 6504005 – Green 6504006 – Yellow 6504007 – Orange 6504008 – Red			Available Colors	6204000 – Gray 6204001 – Blue 6204002 – Black 6204003 – Brown 6204004 – Yellow-Green 6204005 – Green 6204006 – Yellow 6204007 – Orange 6204008 – Red 6204009 – White		
End Plate Qty. pk. 10	6800017 – 44 mm (L) x 35 mm (H) x 1.5 mm (W)			End Plate Qty. pk. 10	6800014 – 72 mm (L) x 55 mm (H) x 1.5 mm (W)		
Separator Qty. pk. 100				Cover Qty. pk. 100	6800080 – 36 mm (L) x 14 mm (H) x 6 mm (W)		
Cover Qty. pk. 100	6800081 – 47 mm (L) x 24.5 mm (H) x 4.8 mm (W)			Jumper-Bar Package	6800190 – .5M Jumper Bar		
Jumper-Bar Package	6800190 – .5M Jumper Bar			Jumpers 2 pole	6800182 – 100 pieces		
Jumpers 2 pole	6800182 – 100 pieces			3 pole	6800183 – 100 pieces		
3 pole	6800183 – 100 pieces			4 pole	6800184 – 100 pieces		
4 pole	6800184 – 100 pieces			End Bracket Qty. pk. 100	6804150 – 58 mm (L) x 36 mm (H) x 9 mm (W)		
End Bracket Qty. pk. 100	6804500 – 25 mm (L) x 16 mm (H) x 7 mm (W)			Test plug adapter (red)	6800501		
				Test plug adapter (black)	6800500		