

SUCS1R5

SUC S 1R5 12 05 B P - □

① ② ③ ④ ⑤ ⑥ ⑦ ⑧

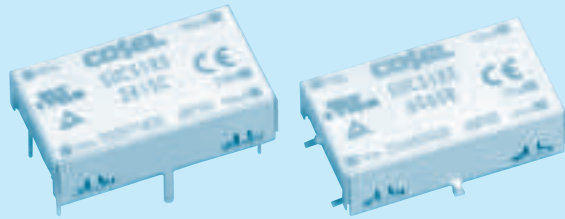
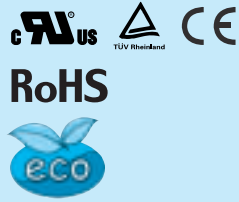

- ① Series name
 - ② Single output
 - ③ Output wattage
 - ④ Input voltage
 - ⑤ Output voltage
 - ⑥ Mounting type
B :SMD
C :DIP
 - ⑦ Packing form
Blank:Plastic cover
P :Tray (SMD type)
 - ⑧ Optional
C :with coating (only DIP type)*
- *Safety standards are pending

MODEL	SUCS1R5053R3	SUCS1R50505	SUCS1R50512	SUCS1R50515	SUCS1R5123R3	SUCS1R51205	SUCS1R51212	SUCS1R51215	
MAX OUTPUT WATTAGE[W]	1.32	1.5	1.56	1.5	1.32	1.5	1.56	1.5	
DC OUTPUT	VOLTAGE[V] *1	3.3	5	12	15	3.3	5	12	15
	CURRENT[A]	0.4	0.3	0.13	0.1	0.4	0.3	0.13	0.1

SPECIFICATIONS

	MODEL	SUCS1R5053R3	SUCS1R50505	SUCS1R50512	SUCS1R50515	SUCS1R5123R3	SUCS1R51205	SUCS1R51212	SUCS1R51215	
INPUT	VOLTAGE[V]	DC4.5 - 9				DC9 - 18				
	CURRENT[A]	*2 0.388typ	0.417typ	0.433typ	0.417typ	0.157typ	0.169typ	0.176typ	0.169typ	
	EFFICIENCY[%]	*2 68typ	72typ	72typ	72typ	70typ	74typ	74typ	74typ	
OUTPUT	VOLTAGE[V]	3.3	5	12	15	3.3	5	12	15	
	CURRENT[A]	0.4	0.3	0.13	0.1	0.4	0.3	0.13	0.1	
	LINE REGULATION[mV]	20max	20max	48max	60max	20max	20max	48max	60max	
	LOAD REGULATION[mV]	40max	40max	100max	120max	40max	40max	100max	120max	
	RIPPLE[mVp-p]	-20 to +55°C *3	80max	80max	120max	120max	80max	80max	120max	120max
		-40 to -20°C *3	120max	120max	150max	150max	120max	120max	150max	150max
	RIPPLE NOISE[mVp-p]	-20 to +55°C *3	120max	120max	150max	150max	120max	120max	150max	150max
		-40 to -20°C *3	200max	200max	200max	200max	200max	200max	200max	200max
	TEMPERATURE REGULATION[mV]	-20 to +55°C	50max	50max	150max	180max	50max	50max	150max	180max
		-40 to +55°C	80max	80max	240max	290max	80max	80max	240max	290max
	DRIFT[mV]	*4 20max	20max	48max	60max	20max	20max	48max	60max	
START-UP TIME[ms]	20max (Minimum input, Io=100%)									
OUTPUT VOLTAGE ADJUSTMENT RANGE	Fixed (TRM pin open) ±5% adjustable by external VR									
OUTPUT VOLTAGE SETTING[V] (±3%)	3.21 - 3.42	4.90 - 5.21	11.64 - 12.36	14.55 - 15.45	3.21 - 3.42	4.90 - 5.21	11.64 - 12.36	14.55 - 15.45		
PROTECTION CIRCUIT AND OTHERS	OVERCURRENT PROTECTION	Works over 105% of rating and recovers automatically								

MODEL	SUCS1R5243R3	SUCS1R52405	SUCS1R52412	SUCS1R52415	SUCS1R5483R3	SUCS1R54805	SUCS1R54812	SUCS1R54815	
MAX OUTPUT WATTAGE[W]	1.32	1.5	1.56	1.5	1.32	1.5	1.56	1.5	
DC OUTPUT	VOLTAGE[V] *1	3.3	5	12	15	3.3	5	12	15
	CURRENT[A]	0.4	0.3	0.13	0.1	0.4	0.3	0.13	0.1

SPECIFICATIONS

	MODEL	SUCS1R5243R3	SUCS1R52405	SUCS1R52412	SUCS1R52415	SUCS1R5483R3	SUCS1R54805	SUCS1R54812	SUCS1R54815	
INPUT	VOLTAGE[V]	DC18 - 36				DC36 - 76				
	CURRENT[A]	*2 0.079typ	0.084typ	0.087typ	0.083typ	0.039typ	0.042typ	0.043typ	0.042typ	
	EFFICIENCY[%]	*2 70typ	74typ	75typ	75typ	70typ	74typ	75typ	75typ	
OUTPUT	VOLTAGE[V]	3.3	5	12	15	3.3	5	12	15	
	CURRENT[A]	0.4	0.3	0.13	0.1	0.4	0.3	0.13	0.1	
	LINE REGULATION[mV]	20max	20max	48max	60max	20max	20max	48max	60max	
	LOAD REGULATION[mV]	40max	40max	100max	120max	40max	40max	100max	120max	
	RIPPLE[mVp-p]	-20 to +55°C *3	80max	80max	120max	120max	80max	80max	120max	120max
		-40 to -20°C *3	120max	120max	150max	150max	120max	120max	150max	150max
	RIPPLE NOISE[mVp-p]	-20 to +55°C *3	120max	120max	150max	150max	120max	120max	150max	150max
		-40 to -20°C *3	200max	200max	200max	200max	200max	200max	200max	200max
	TEMPERATURE REGULATION[mV]	-20 to +55°C	50max	50max	150max	180max	50max	50max	150max	180max
		-40 to +55°C	80max	80max	240max	290max	80max	80max	240max	290max
	DRIFT[mV]	*4 20max	20max	48max	60max	20max	20max	48max	60max	
START-UP TIME[ms]	20max (Minimum input, Io=100%)									
OUTPUT VOLTAGE ADJUSTMENT RANGE	Fixed (TRM pin open) ±5% adjustable by external VR									
OUTPUT VOLTAGE SETTING[V] (±3%)	3.21 - 3.42	4.90 - 5.21	11.64 - 12.36	14.55 - 15.45	3.21 - 3.42	4.90 - 5.21	11.64 - 12.36	14.55 - 15.45		
PROTECTION CIRCUIT AND OTHERS	OVERCURRENT PROTECTION	Works over 105% of rating and recovers automatically								

GENERAL SPECIFICATIONS

ISOLATION	INPUT-OUTPUT	AC500V 1minute, Cutoff current = 10mA, DC500V 50MΩ min (20±15°C)
	INPUT-CASE	AC500V 1minute, Cutoff current = 10mA, DC500V 50MΩ min (20±15°C)
	OUTPUT-CASE	AC500V 1minute, Cutoff current = 10mA, DC500V 50MΩ min (20±15°C)
ENVIRONMENT	OPERATING TEMP., HUMID. AND ALTITUDE	-40 to +85°C, 20 - 95%RH (Non condensing) (Required Derating), 3,000m (10,000feet) max
	STORAGE TEMP., HUMID. AND ALTITUDE	-40 to +100°C, 20 - 95%RH (Non condensing), 9,000m (30,000feet) max
	VIBRATION	10 - 55Hz, 98.0m/s ² (10G), 3minutes period, 60minutes each along X, Y and Z axis
	IMPACT	490.3m/s ² (50G), 11ms, once each along X, Y and Z axis
SAFETY	AGENCY APPROVALS	UL60950-1, C-UL, EN60950-1
OTHERS	CASE SIZE/WEIGHT	22.4 × 7.0 × 13.2mm [0.88 × 0.28 × 0.52 inches] (W × H × D) / 3g max
	COOLING METHOD	Convection/Forced air

- *1 SUCW1R5xx12/SUCW1R5xx15 is available as single output, +24V/+30V.
- *2 Rated input 5V, 12V, 24V or 48V DC I_o=100%
- *3 Ripple and Ripple Noise is measured by using measuring board with capacitor with in 25mm from output pin terminals.
- *4 Drift is the change in DC output for an eight hour period after a half-hour warm-up at 25°C.
- * Parallel operation with other model is not possible.

External view

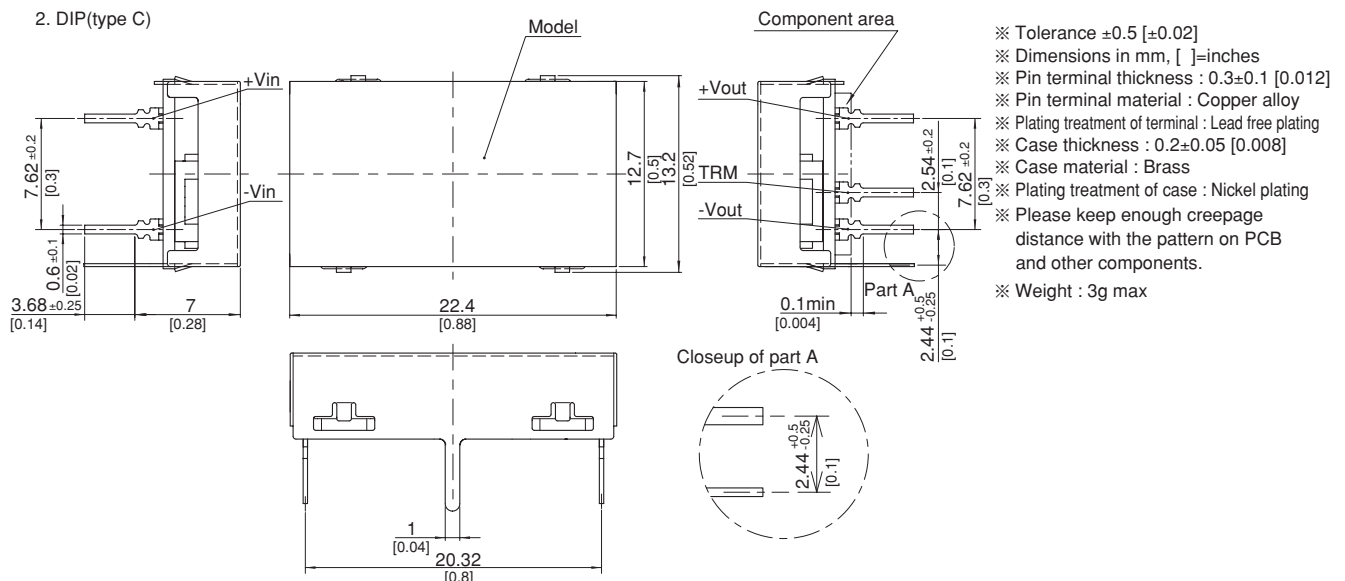
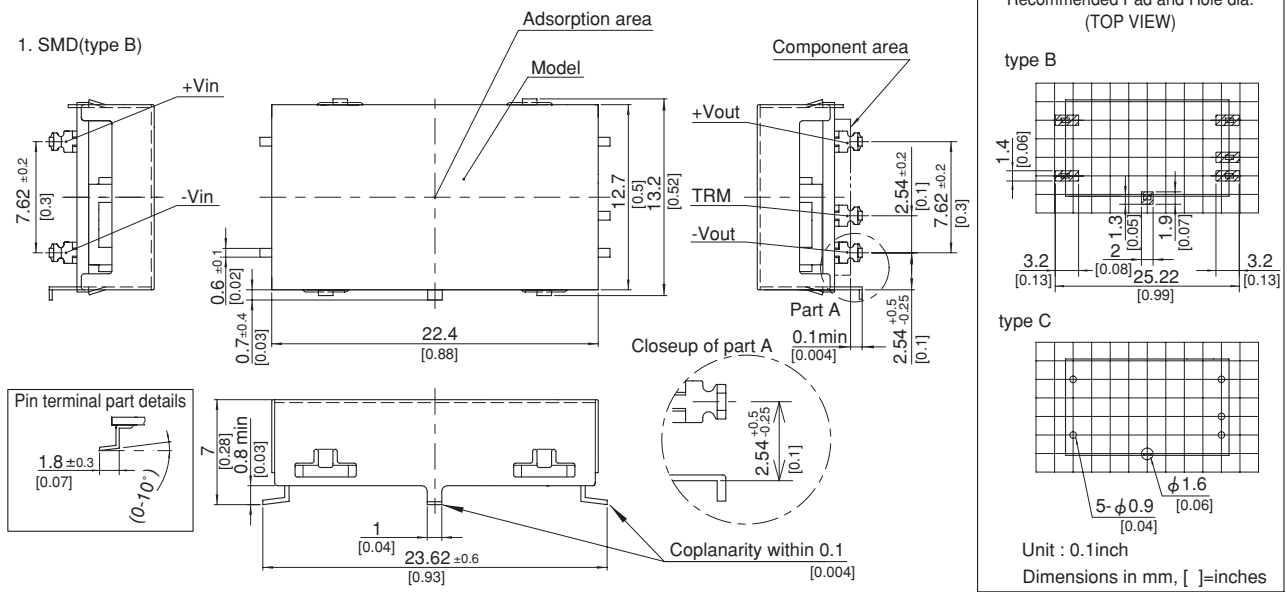

SUCS3

SUC S 3 12 05 B P - □

① ② ③ ④ ⑤ ⑥ ⑦ ⑧

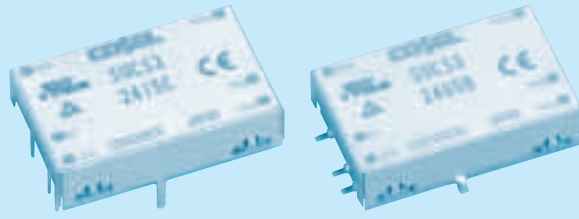
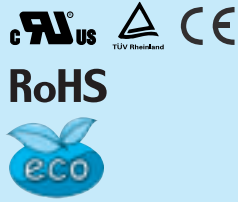

- ① Series name
 - ② Single output
 - ③ Output wattage
 - ④ Input voltage
 - ⑤ Output voltage
 - ⑥ Mounting type
B :SMD
C :DIP
 - ⑦ Packing form
Blank:Plastic cover
P :Tray (SMD type)
 - ⑧ Optional
G :Capacitor between Input and Output is removed.
C :with coating (only DIP type)*
- * Safety standards are pending

MODEL	SUCS3053R3	SUCS30505	SUCS30512	SUCS30515	SUCS3123R3	SUCS31205	SUCS31212	SUCS31215	
MAX OUTPUT WATTAGE[W]	1.98	3	3	3	1.98	3	3	3	
DC OUTPUT	VOLTAGE[V] *1	3.3	5	12	15	3.3	5	12	15
	CURRENT[A]	0.6	0.6	0.25	0.2	0.6	0.6	0.25	0.2

SPECIFICATIONS

	MODEL	SUCS3053R3	SUCS30505	SUCS30512	SUCS30515	SUCS3123R3	SUCS31205	SUCS31212	SUCS31215	
INPUT	VOLTAGE[V]	DC4.5 - 9				DC9 - 18				
	CURRENT[A] *2	0.550typ	0.800typ	0.780typ	0.780typ	0.223typ	0.325typ	0.317typ	0.321typ	
	EFFICIENCY[%] *2	72typ	75typ	77typ	77typ	74typ	77typ	79typ	78typ	
OUTPUT	VOLTAGE[V]	3.3	5	12	15	3.3	5	12	15	
	CURRENT[A]	0.6	0.6	0.25	0.2	0.6	0.6	0.25	0.2	
	LINE REGULATION[mV]	20max	20max	48max	60max	20max	20max	48max	60max	
	LOAD REGULATION[mV]	40max	40max	100max	120max	40max	40max	100max	120max	
	RIPPLE[mVp-p]	-20 to +55°C *3	80max	80max	120max	120max	80max	80max	120max	120max
		-40 to -20°C *3	120max	120max	150max	150max	120max	120max	150max	150max
	RIPPLE NOISE[mVp-p]	-20 to +55°C *3	120max	120max	150max	150max	120max	120max	150max	150max
		-40 to -20°C *3	200max	200max	200max	200max	200max	200max	200max	200max
	TEMPERATURE REGULATION[mV]	-20 to +55°C	50max	50max	150max	180max	50max	50max	150max	180max
		-40 to +55°C	80max	80max	240max	290max	80max	80max	240max	290max
DRIFT[mV] *4	20max	20max	48max	60max	20max	20max	48max	60max		
START-UP TIME[ms]	20max (Minimum input, Io=100%)									
OUTPUT VOLTAGE ADJUSTMENT RANGE	Fixed (TRM pin open) ±5% adjustable by external VR									
OUTPUT VOLTAGE SETTING[V] (±3%)	3.21 - 3.42	4.90 - 5.21	11.64 - 12.36	14.55 - 15.45	3.21 - 3.42	4.90 - 5.21	11.64 - 12.36	14.55 - 15.45		
PROTECTION CIRCUIT AND OTHERS	OVERCURRENT PROTECTION	Works over 105% of rating and recovers automatically								
	REMOTE ON/OFF	Provided (Negative logic L : ON, H : OFF)								

MODEL	SUCS3243R3	SUCS32405	SUCS32412	SUCS32415	SUCS3483R3	SUCS34805	SUCS34812	SUCS34815	
MAX OUTPUT WATTAGE[W]	1.98	3	3	3	1.98	3	3	3	
DC OUTPUT	VOLTAGE[V] *1	3.3	5	12	15	3.3	5	12	15
	CURRENT[A]	0.6	0.6	0.25	0.2	0.6	0.6	0.25	0.2

SPECIFICATIONS

	MODEL	SUCS3243R3	SUCS32405	SUCS32412	SUCS32415	SUCS3483R3	SUCS34805	SUCS34812	SUCS34815	
INPUT	VOLTAGE[V]	DC18 - 36				DC36 - 76				
	CURRENT[A] *2	0.114typ	0.163typ	0.159typ	0.161typ	0.057typ	0.082typ	0.080typ	0.080typ	
	EFFICIENCY[%] *2	73typ	77typ	79typ	78typ	72typ	77typ	79typ	79typ	
OUTPUT	VOLTAGE[V]	3.3	5	12	15	3.3	5	12	15	
	CURRENT[A]	0.6	0.6	0.25	0.2	0.6	0.6	0.25	0.2	
	LINE REGULATION[mV]	20max	20max	48max	60max	20max	20max	48max	60max	
	LOAD REGULATION[mV]	40max	40max	100max	120max	40max	40max	100max	120max	
	RIPPLE[mVp-p]	-20 to +55°C *3	80max	80max	120max	120max	80max	80max	120max	120max
		-40 to -20°C *3	120max	120max	150max	150max	120max	120max	150max	150max
	RIPPLE NOISE[mVp-p]	-20 to +55°C *3	120max	120max	150max	150max	120max	120max	150max	150max
		-40 to -20°C *3	200max	200max	200max	200max	200max	200max	200max	200max
	TEMPERATURE REGULATION[mV]	-20 to +55°C	50max	50max	150max	180max	50max	50max	150max	180max
		-40 to +55°C	80max	80max	240max	290max	80max	80max	240max	290max
DRIFT[mV] *4	20max	20max	48max	60max	20max	20max	48max	60max		
START-UP TIME[ms]	20max (Minimum input, Io=100%)									
OUTPUT VOLTAGE ADJUSTMENT RANGE	Fixed (TRM pin open) ±5% adjustable by external VR									
OUTPUT VOLTAGE SETTING[V] (±3%)	3.21 - 3.42	4.90 - 5.21	11.64 - 12.36	14.55 - 15.45	3.21 - 3.42	4.90 - 5.21	11.64 - 12.36	14.55 - 15.45		
PROTECTION CIRCUIT AND OTHERS	OVERCURRENT PROTECTION	Works over 105% of rating and recovers automatically								
	REMOTE ON/OFF	Provided (Negative logic L : ON, H : OFF)								

GENERAL SPECIFICATIONS

ISOLATION	INPUT-OUTPUT	AC500V 1minute, Cutoff current = 10mA, DC500V 50MΩ min (20±15°C)
	INPUT-CASE	AC500V 1minute, Cutoff current = 10mA, DC500V 50MΩ min (20±15°C)
	OUTPUT-CASE	AC500V 1minute, Cutoff current = 10mA, DC500V 50MΩ min (20±15°C)
ENVIRONMENT	OPERATING TEMP.,HUMID.AND ALTIUDE	-40 to +85°C, 20 - 95%RH (Non condensing) (Required Derating), 3,000m (10,000feet) max
	STORAGE TEMP.,HUMID.AND ALTIUDE	-40 to +100°C, 20 - 95%RH (Non condensing), 9,000m (30,000feet) max
	VIBRATION	10 - 55Hz, 98.0m/s ² (10G), 3minutes period, 60minutes each along X, Y and Z axis
	IMPACT	490.3m/s ² (50G), 11ms, once each along X, Y and Z axis
SAFETY	AGENCY APPROVALS	UL60950-1, C-UL, EN60950-1
OTHERS	CASE SIZE/WEIGHT	25×7.0×16.1mm [0.98×0.28×0.63 inches] (W×H×D) / 5g max
	COOLING METHOD	Convection/Forced air

- *1 SUCW3xx12/SUCW3xx15 is available as single output, +24V/+30V.
- *2 Rated input 5V, 12V, 24V or 48V DC I_o=100%
- *3 Ripple and Ripple Noise is measured by using measuring board with capacitor with in 25mm from output pin terminals.
- *4 Drift is the change in DC output for an eight hour period after a half-hour warm-up at 25°C.
- * Parallel operation with other model is not possible.

External view

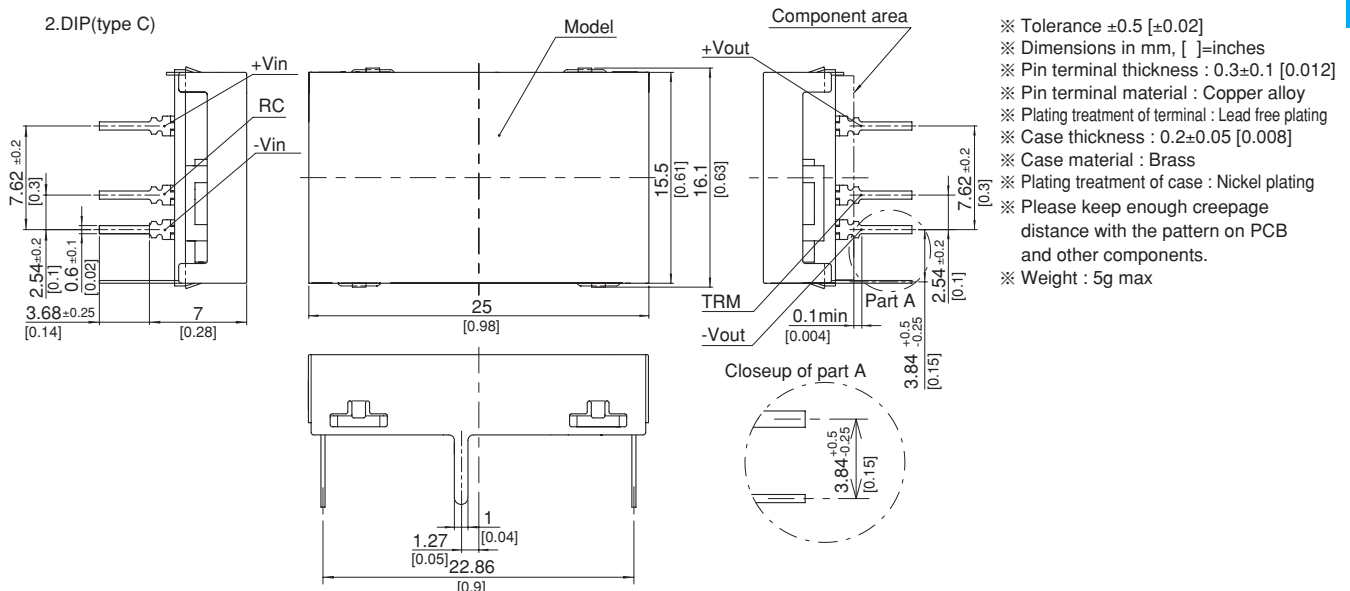
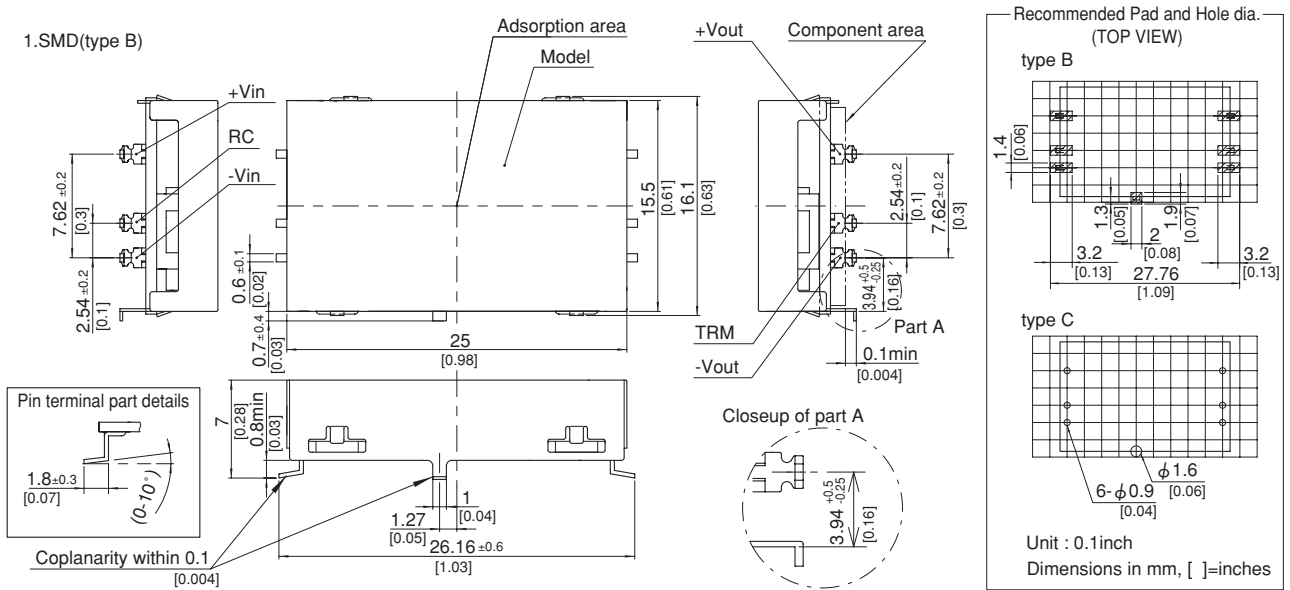

SE-SUC/SUT

SUCS6

SUC S 6 12 05 B P - □

① ② ③ ④ ⑤ ⑥ ⑦ ⑧

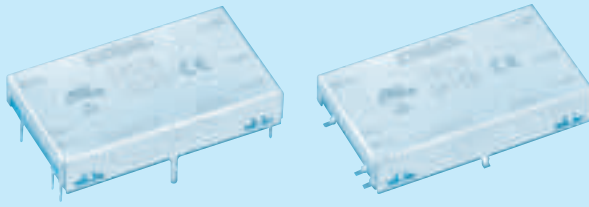
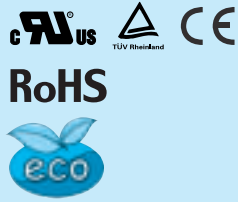

- ① Series name
 - ② Single output
 - ③ Output wattage
 - ④ Input voltage
 - ⑤ Output voltage
 - ⑥ Mounting type
B :SMD
C :DIP
 - ⑦ Packing form
Blank:Plastic cover
P :Tray (SMD type)
 - ⑧ Optional
G :Capacitor between Input and Output is removed.
C :with coating (only DIP type)*
- * Safety standards are pending

MODEL	SUCS6053R3	SUCS60505	SUCS60512	SUCS60515	SUCS6123R3	SUCS61205	SUCS61212	SUCS61215	
MAX OUTPUT WATTAGE[W]	3.96	5	6	6	4.46	6	6	6	
DC OUTPUT	VOLTAGE[V] *1	3.3	5	12	15	3.3	5	12	15
	CURRENT[A]	1.2	1	0.5	0.4	1.35	1.2	0.5	0.4

SPECIFICATIONS

	MODEL	SUCS6053R3	SUCS60505	SUCS60512	SUCS60515	SUCS6123R3	SUCS61205	SUCS61212	SUCS61215	
INPUT	VOLTAGE[V]	DC4.5 - 9				DC9 - 18				
	CURRENT[A] *2	1.100typ	1.316typ	1.500typ	1.500typ	0.502typ	0.617typ	0.588typ	0.588typ	
	EFFICIENCY[%] *2	72typ	76typ	80typ	80typ	74typ	81typ	85typ	85typ	
OUTPUT	VOLTAGE[V]	3.3	5	12	15	3.3	5	12	15	
	CURRENT[A]	1.2	1	0.5	0.4	1.35	1.2	0.5	0.4	
	LINE REGULATION[mV]	20max	20max	48max	60max	20max	20max	48max	60max	
	LOAD REGULATION[mV]	40max	40max	100max	120max	40max	40max	100max	120max	
	RIPPLE[mVp-p]	-20 to +55°C *3	80max	80max	120max	120max	80max	80max	120max	120max
		-40 to -20°C *3	120max	120max	150max	150max	120max	120max	150max	150max
	RIPPLE NOISE[mVp-p]	-20 to +55°C *3	120max	120max	150max	150max	120max	120max	150max	150max
		-40 to -20°C *3	200max	200max	200max	200max	200max	200max	200max	200max
	TEMPERATURE REGULATION[mV]	-20 to +55°C	50max	50max	150max	180max	50max	50max	150max	180max
		-40 to +55°C	80max	80max	240max	290max	80max	80max	240max	290max
DRIFT[mV] *4	20max	20max	48max	60max	20max	20max	48max	60max		
START-UP TIME[ms]	20max (Minimum input, Io=100%)									
OUTPUT VOLTAGE ADJUSTMENT RANGE	Fixed (TRM pin open) ±5% adjustable by external VR									
OUTPUT VOLTAGE SETTING[V] (±3%)	3.21 - 3.42	4.90 - 5.21	11.64 - 12.36	14.55 - 15.45	3.21 - 3.42	4.90 - 5.21	11.64 - 12.36	14.55 - 15.45		
PROTECTION CIRCUIT AND OTHERS	OVERCURRENT PROTECTION	Works over 105% of rating and recovers automatically								
	REMOTE ON/OFF	Provided (Negative logic L : ON, H : OFF)								

MODEL	SUCS6243R3	SUCS62405	SUCS62412	SUCS62415	SUCS6483R3	SUCS64805	SUCS64812	SUCS64815	
MAX OUTPUT WATTAGE[W]	4.46	6	6	6	4.46	6	6	6	
DC OUTPUT	VOLTAGE[V] *1	3.3	5	12	15	3.3	5	12	15
	CURRENT[A]	1.35	1.2	0.5	0.4	1.35	1.2	0.5	0.4

SPECIFICATIONS

	MODEL	SUCS6243R3	SUCS62405	SUCS62412	SUCS62415	SUCS6483R3	SUCS64805	SUCS64812	SUCS64815	
INPUT	VOLTAGE[V]	DC18 - 36				DC36 - 76				
	CURRENT[A] *2	0.248typ	0.309typ	0.291typ	0.291typ	0.121typ	0.154typ	0.145typ	0.145typ	
	EFFICIENCY[%] *2	75typ	81typ	86typ	86typ	77typ	81typ	86typ	86typ	
OUTPUT	VOLTAGE[V]	3.3	5	12	15	3.3	5	12	15	
	CURRENT[A]	1.35	1.2	0.5	0.4	1.35	1.2	0.5	0.4	
	LINE REGULATION[mV]	20max	20max	48max	60max	20max	20max	48max	60max	
	LOAD REGULATION[mV]	40max	40max	100max	120max	40max	40max	100max	120max	
	RIPPLE[mVp-p]	-20 to +55°C *3	80max	80max	120max	120max	80max	80max	120max	120max
		-40 to -20°C *3	120max	120max	150max	150max	120max	120max	150max	150max
	RIPPLE NOISE[mVp-p]	-20 to +55°C *3	120max	120max	150max	150max	120max	120max	150max	150max
		-40 to -20°C *3	200max	200max	200max	200max	200max	200max	200max	200max
	TEMPERATURE REGULATION[mV]	-20 to +55°C	50max	50max	150max	180max	50max	50max	150max	180max
		-40 to +55°C	80max	80max	240max	290max	80max	80max	240max	290max
DRIFT[mV] *4	20max	20max	48max	60max	20max	20max	48max	60max		
START-UP TIME[ms]	20max (Minimum input, Io=100%)									
OUTPUT VOLTAGE ADJUSTMENT RANGE	Fixed (TRM pin open) ±5% adjustable by external VR									
OUTPUT VOLTAGE SETTING[V] (±3%)	3.21 - 3.42	4.90 - 5.21	11.64 - 12.36	14.55 - 15.45	3.21 - 3.42	4.90 - 5.21	11.64 - 12.36	14.55 - 15.45		
PROTECTION CIRCUIT AND OTHERS	OVERCURRENT PROTECTION	Works over 105% of rating and recovers automatically								
	REMOTE ON/OFF	Provided (Negative logic L : ON, H : OFF)								

GENERAL SPECIFICATIONS

ISOLATION	INPUT-OUTPUT	AC500V 1minute, Cutoff current = 10mA, DC500V 50MΩ min (20±15°C)
	INPUT-CASE	AC500V 1minute, Cutoff current = 10mA, DC500V 50MΩ min (20±15°C)
	OUTPUT-CASE	AC500V 1minute, Cutoff current = 10mA, DC500V 50MΩ min (20±15°C)
ENVIRONMENT	OPERATING TEMP.,HUMID.AND ALTITUDE	-40 to +85°C, 20 - 95%RH (Non condensing) (Required Derating), 3,000m (10,000feet) max
	STORAGE TEMP.,HUMID.AND ALTITUDE	-40 to +100°C, 20 - 95%RH (Non condensing), 9,000m (30,000feet) max
	VIBRATION	10 - 55Hz, 98.0m/s ² (10G), 3minutes period, 60minutes each along X, Y and Z axis
	IMPACT	490.3m/s ² (50G), 11ms, once each along X, Y and Z axis
SAFETY	AGENCY APPROVALS	UL60950-1, C-UL, EN60950-1
OTHERS	CASE SIZE/WEIGHT	32.6×7.0×19.1mm [1.28×0.28×0.75 inches] (W×H×D) / 7g max
	COOLING METHOD	Convection/Forced air

- *1 SUCW6xx12/SUCW6xx15 is available as single output, +24V/+30V.
- *2 Rated input 5V, 12V, 24V or 48V DC Io=100%
- *3 Ripple and Ripple Noise is measured by using measuring board with capacitor with in 25mm from output pin terminals.
- *4 Drift is the change in DC output for an eight hour period after a half-hour warm-up at 25°C.
- * Parallel operation with other model is not possible.

External view

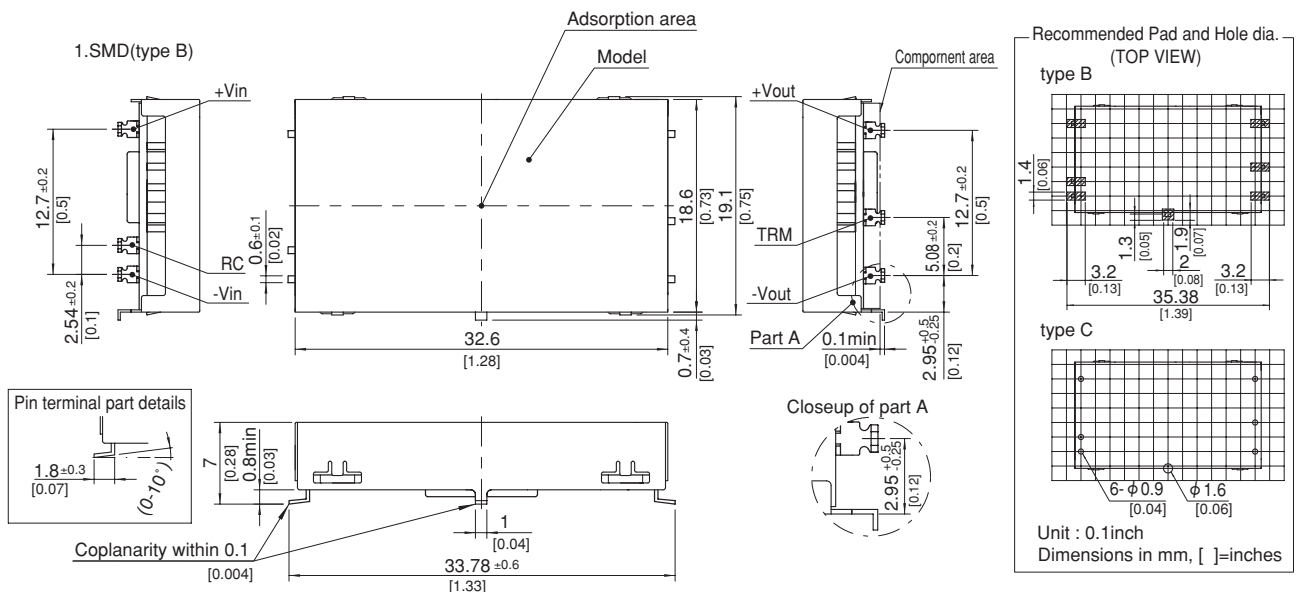

- ※ Tolerance ±0.5 [±0.02]
- ※ Dimensions in mm, []=inches
- ※ Pin terminal thickness : 0.3±0.1 [0.012]
- ※ Pin terminal material : Copper alloy
- ※ Plating treatment of terminal : Lead free plating
- ※ Case thickness : 0.2±0.05 [0.008]
- ※ Case material : Brass
- ※ Plating treatment of case : Nickel plating
- ※ Please keep enough creepage distance with the pattern on PCB and other components.
- ※ Weight : 7g max

SU-SUC/SUT

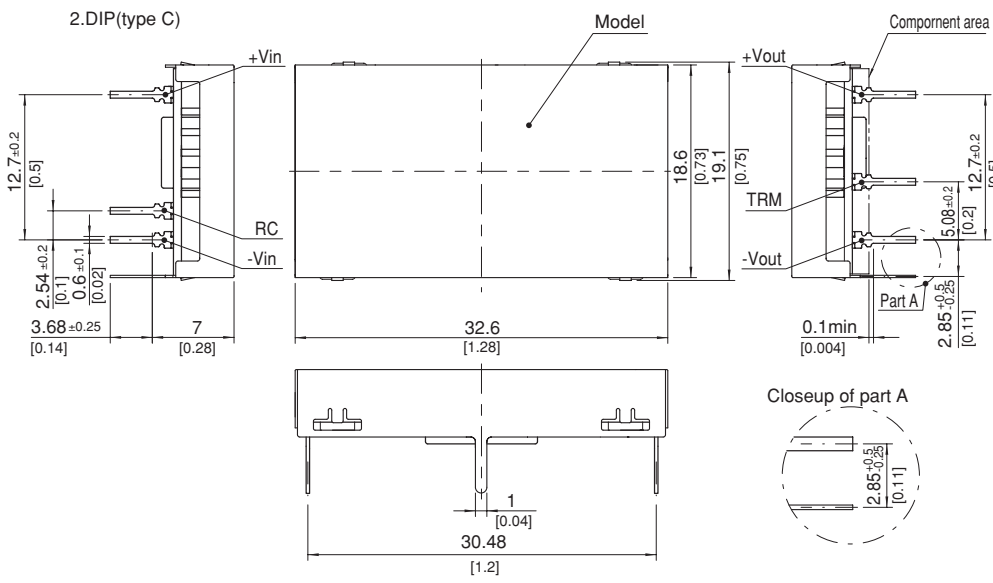

SUCS10

SUC S 10 12 05 B P - □

① ② ③ ④ ⑤ ⑥ ⑦ ⑧

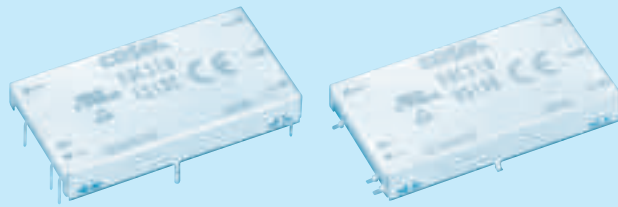
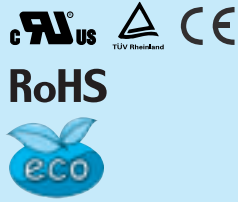

- ① Series name
- ② Single output
- ③ Output wattage
- ④ Input voltage
- ⑤ Output voltage
- ⑥ Mounting type
B :SMD
C :DIP
- ⑦ Packing form
Blank:Plastic cover
P :Tray (SMD type)
- ⑧ Optional
G :Capacitor between Input and Output is removed.
C :with coating (only DIP type)*
* Safety standards are pending

MODEL	SUCS10053R3	SUCS100505	SUCS100512	SUCS100515	SUCS10123R3	SUCS101205	SUCS101212	SUCS101215	
MAX OUTPUT WATTAGE[W]	8.58	10	10.8	10.5	8.58	10	12	12	
DC OUTPUT	VOLTAGE[V] *1	3.3	5	12	15	3.3	5	12	15
	CURRENT[A]	2.6	2	0.9	0.7	2.6	2	1	0.8

SPECIFICATIONS

	MODEL	SUCS10053R3	SUCS100505	SUCS100512	SUCS100515	SUCS10123R3	SUCS101205	SUCS101212	SUCS101215	
INPUT	VOLTAGE[V]	DC4.5 - 9				DC9 - 18				
	CURRENT[A] *2	2.12typ	2.41typ	2.54typ	2.47typ	0.872typ	0.980typ	1.15typ	1.15typ	
	EFFICIENCY[%] *2	81typ	83typ	85typ	85typ	82typ	85typ	87typ	87typ	
OUTPUT	VOLTAGE[V]	3.3	5	12	15	3.3	5	12	15	
	CURRENT[A]	2.6	2	0.9	0.7	2.6	2	1	0.8	
	LINE REGULATION[mV]	20max	20max	48max	60max	20max	20max	48max	60max	
	LOAD REGULATION[mV]	40max	40max	100max	120max	40max	40max	100max	120max	
	RIPPLE[mVp-p]	-20 to +55°C *3	80max	80max	120max	120max	80max	80max	120max	120max
		-40 to -20°C *3	120max	120max	150max	150max	120max	120max	150max	150max
	RIPPLE NOISE[mVp-p]	-20 to +55°C *3	120max	120max	150max	150max	120max	120max	150max	150max
		-40 to -20°C *3	200max	200max	200max	200max	200max	200max	200max	200max
	TEMPERATURE REGULATION[mV]	-20 to +55°C	50max	50max	150max	180max	50max	50max	150max	180max
		-40 to +55°C	80max	80max	240max	290max	80max	80max	240max	290max
DRIFT[mV] *4	20max	20max	48max	60max	20max	20max	48max	60max		
START-UP TIME[ms]	20max (Minimum input, Io=100%)									
OUTPUT VOLTAGE ADJUSTMENT RANGE	Fixed (TRM pin open) ±5% adjustable by external VR									
OUTPUT VOLTAGE SETTING[V] (±3%)	3.21 - 3.42	4.90 - 5.21	11.64 - 12.36	14.55 - 15.45	3.21 - 3.42	4.90 - 5.21	11.64 - 12.36	14.55 - 15.45		
PROTECTION CIRCUIT AND OTHERS	OVERCURRENT PROTECTION	Works over 105% of rating and recovers automatically								
	REMOTE ON/OFF	Provided (Negative logic L : ON, H : OFF)								

MODEL	SUCS10243R3	SUCS102405	SUCS102412	SUCS102415	SUCS10483R3	SUCS104805	SUCS104812	SUCS104815	
MAX OUTPUT WATTAGE[W]	8.58	10	12	12	8.58	10	12	12	
DC OUTPUT	VOLTAGE[V] *1	3.3	5	12	15	3.3	5	12	15
	CURRENT[A]	2.6	2	1	0.8	2.6	2	1	0.8

SPECIFICATIONS

	MODEL	SUCS10243R3	SUCS102405	SUCS102412	SUCS102415	SUCS10483R3	SUCS104805	SUCS104812	SUCS104815	
INPUT	VOLTAGE[V]	DC18 - 36				DC36 - 76				
	CURRENT[A] *2	0.436typ	0.490typ	0.575typ	0.575typ	0.218typ	0.245typ	0.287typ	0.287typ	
	EFFICIENCY[%] *2	82typ	85typ	87typ	87typ	82typ	85typ	87typ	87typ	
OUTPUT	VOLTAGE[V]	3.3	5	12	15	3.3	5	12	15	
	CURRENT[A]	2.6	2	1	0.8	2.6	2	1	0.8	
	LINE REGULATION[mV]	20max	20max	48max	60max	20max	20max	48max	60max	
	LOAD REGULATION[mV]	40max	40max	100max	120max	40max	40max	100max	120max	
	RIPPLE[mVp-p]	-20 to +55°C *3	80max	80max	120max	120max	80max	80max	120max	120max
		-40 to -20°C *3	120max	120max	150max	150max	120max	120max	150max	150max
	RIPPLE NOISE[mVp-p]	-20 to +55°C *3	120max	120max	150max	150max	120max	120max	150max	150max
		-40 to -20°C *3	200max	200max	200max	200max	200max	200max	200max	200max
	TEMPERATURE REGULATION[mV]	-20 to +55°C	50max	50max	150max	180max	50max	50max	150max	180max
		-40 to +55°C	80max	80max	240max	290max	80max	80max	240max	290max
DRIFT[mV] *4	20max	20max	48max	60max	20max	20max	48max	60max		
START-UP TIME[ms]	20max (Minimum input, Io=100%)									
OUTPUT VOLTAGE ADJUSTMENT RANGE	Fixed (TRM pin open) ±5% adjustable by external VR									
OUTPUT VOLTAGE SETTING[V] (±3%)	3.21 - 3.42	4.90 - 5.21	11.64 - 12.36	14.55 - 15.45	3.21 - 3.42	4.90 - 5.21	11.64 - 12.36	14.55 - 15.45		
PROTECTION CIRCUIT AND OTHERS	OVERCURRENT PROTECTION	Works over 105% of rating and recovers automatically								
	REMOTE ON/OFF	Provided (Negative logic L : ON, H : OFF)								

GENERAL SPECIFICATIONS

ISOLATION	INPUT-OUTPUT	AC500V 1minute, Cutoff current = 10mA, DC500V 50MΩ min (20±15°C)
	INPUT-CASE	AC500V 1minute, Cutoff current = 10mA, DC500V 50MΩ min (20±15°C)
	OUTPUT-CASE	AC500V 1minute, Cutoff current = 10mA, DC500V 50MΩ min (20±15°C)
ENVIRONMENT	OPERATING TEMP., HUMID. AND ALTITUDE	-40 to +85°C, 20 - 95%RH (Non condensing) (Required Derating), 3,000m (10,000feet) max
	STORAGE TEMP., HUMID. AND ALTITUDE	-40 to +100°C, 20 - 95%RH (Non condensing), 9,000m (30,000feet) max
	VIBRATION	10 - 55Hz, 98.0m/s ² (10G), 3minutes period, 60minutes each along X, Y and Z axis
	IMPACT	490.3m/s ² (50G), 11ms, once each along X, Y and Z axis
SAFETY	AGENCY APPROVALS	UL60950-1, C-UL, EN60950-1
OTHERS	CASE SIZE/WEIGHT	40.2×7.0×22.0mm [1.58×0.28×0.87 inches] (W×H×D) / 10g max
	COOLING METHOD	Convection/Forced air

- *1 SUCW10xx12/SUCW10xx15 is available as single output, +24V/+30V.
- *2 Rated input 5V, 12V, 24V or 48V DC I_o=100%
- *3 Ripple and Ripple Noise is measured by using measuring board with capacitor with in 25mm from output pin terminals.
- *4 Drift is the change in DC output for an eight hour period after a half-hour warm-up at 25°C.
- * Parallel operation with other model is not possible.

External view

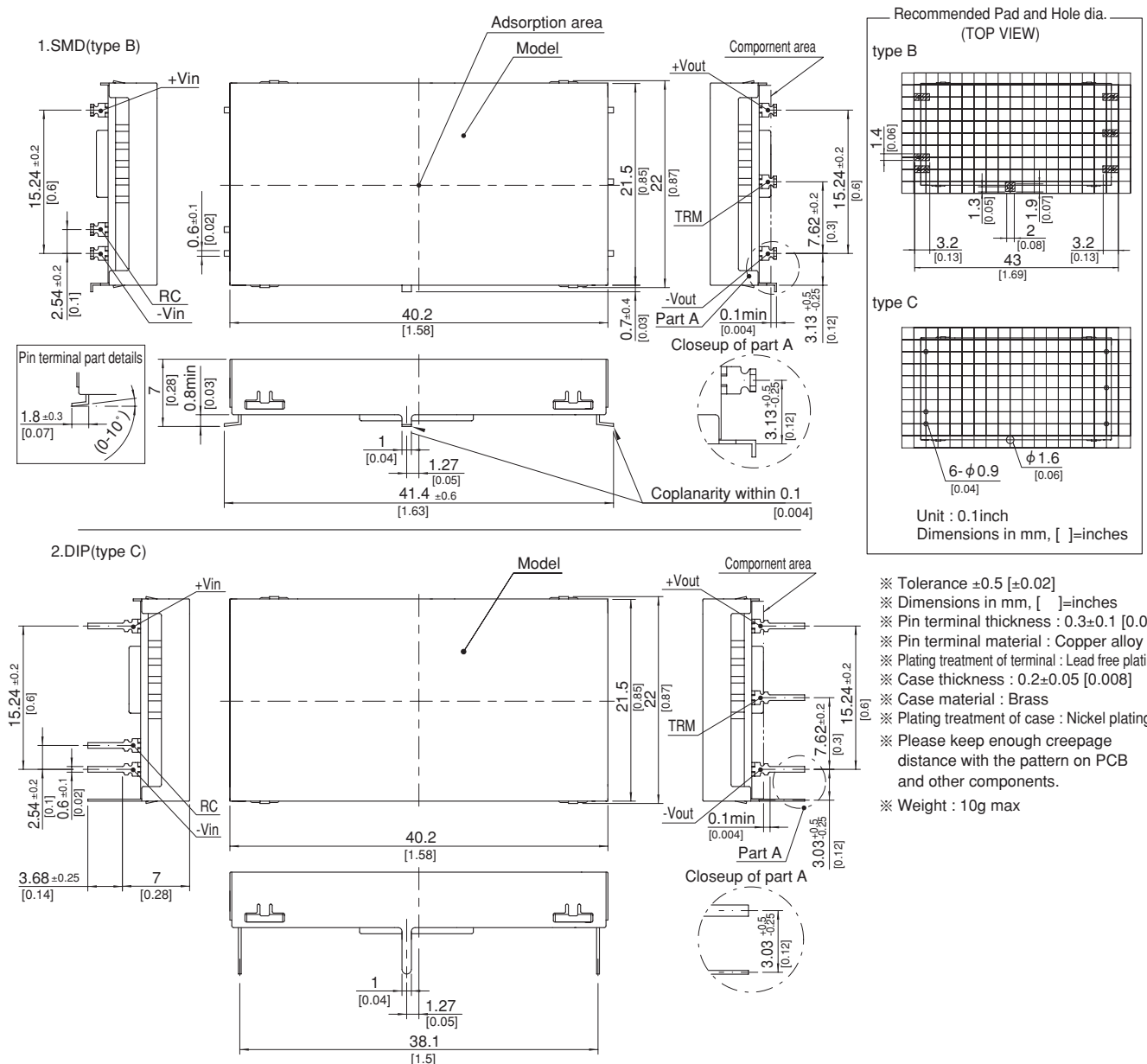

SUCSUT

- ※ Tolerance ±0.5 [±0.02]
- ※ Dimensions in mm, []=inches
- ※ Pin terminal thickness : 0.3±0.1 [0.012]
- ※ Pin terminal material : Copper alloy
- ※ Plating treatment of terminal : Lead free plating
- ※ Case thickness : 0.2±0.05 [0.008]
- ※ Case material : Brass
- ※ Plating treatment of case : Nickel plating
- ※ Please keep enough creepage distance with the pattern on PCB and other components.
- ※ Weight : 10g max