

Sales Outline Drawing

Revision **A**

Specifications:

Resonant Frequency (Hz)	3500 ± 500
Operating Voltage (Vdc/max)	3 ~ 28
Rated Voltage (Vdc)	12
Current Consumption (mA/max)	10 at Rated Voltage
Sound Pressure Level (dB/min)	88 at 30cm at Rated voltage
Operating Temperature (°C)	-20 ~ +90
Storage Temperature (°C)	-30 ~ +100
Housing	ABS 777D UL94HB plastic resin (Color: Black)
Lead Pins	Tin Plated Brass
Weight (Grams)	4.2
Condition by wave soldering (°C)	245 ±5 / 3±0.5 sec
Condition by hand soldering (°C)	350 ±20 / within 5 sec
Options	For other options contact factory

PS: Vp-p = 1/2duty, square wave

RoHS Compliant

Dimensions: (units: mm)

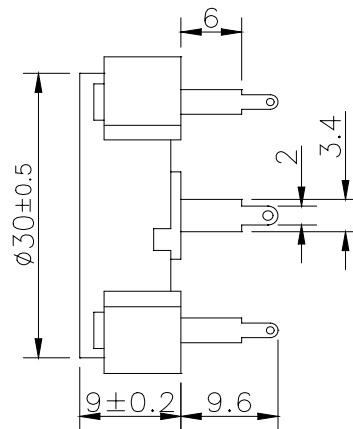
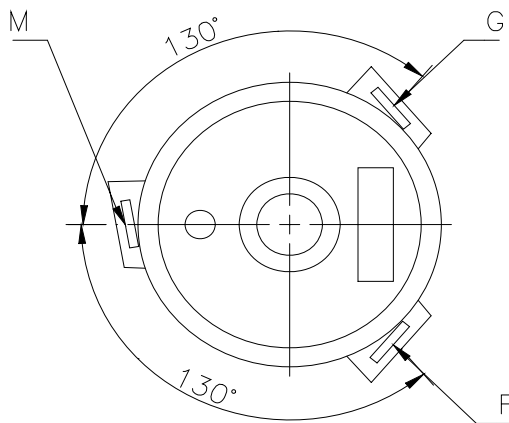

Recommended Driving Circuit

