

Sales Outline Drawing**Specifications:**

Voice Coil Impedance (Ω)	$8 \pm 15\%$ at 800 Hz / 1.0 V
Rated Input (W)	0.25
Max. Input (W)	0.50
Lowest Resonance Freq F_o (Hz)	$550 \pm 20\%$
Frequency Range (Hz)	$F_o \sim 7000$
Output S.P.L. (dB)	89 ± 3 at 1W 1M .8k, 1k, 1.2k, 1.5kHz
Magnet Size (mm)	$\varnothing 12.5 * 1.5$
Magnet	Ferrite
Core Material Mylar	Black
Frame Material	Metal
Operation / Storage Temp	-25 to 50°C
Options	For other options contact factory

Dimensions: (units: mm)**ROHS Compliant**

Frequency Response:

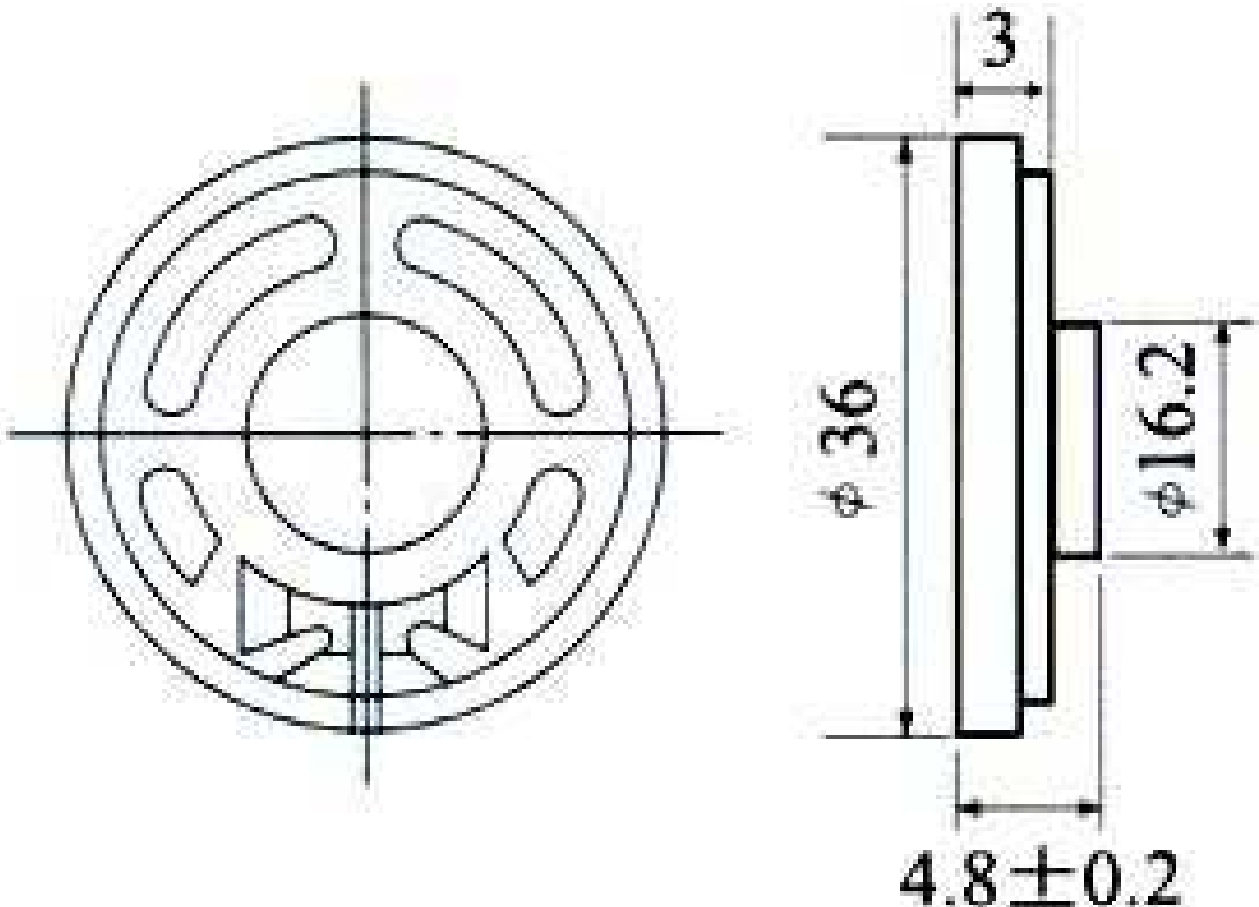