



BAS116H

Low leakage switching diode

Rev. 3 — 31 May 2011

Product data sheet

1. Product profile

1.1 General description

Low leakage switching diode, encapsulated in a SOD123F small and flat lead Surface-Mounted Device (SMD) plastic package.

1.2 Features and benefits

- Small and flat lead SMD plastic package
- Low leakage current
- Excellent coplanarity and improved thermal behavior
- AEC-Q101 qualified

1.3 Applications

- General-purpose switching

1.4 Quick reference data

Table 1. Quick reference data

Symbol	Parameter	Conditions	Min	Typ	Max	Unit
I_F	forward current		[1][2]	-	215	mA
I_R	reverse current	$V_R = 75\text{ V}$	-	0.003	5.0	nA
V_R	reverse voltage		-	-	75	V
t_{rr}	reverse recovery time		[3]	0.8	3.0	μs



[1] Pulse test: $t_p \leq 300\ \mu\text{s}$; $\delta \leq 0.02$.

[2] Device mounted on an FR4 Printed-Circuit Board (PCB), single-sided copper, tin-plated and standard footprint.

[3] When switched from $I_F = 10\ \text{mA}$ to $I_R = 10\ \text{mA}$; $R_L = 100\ \Omega$; measured at $I_R = 1\ \text{mA}$.

2. Pinning information

Table 2. Pinning

Pin	Description	Simplified outline	Graphic symbol
1	cathode	[1]	1  2
2	anode		 sym001

[1] The marking bar indicates the cathode.



3. Ordering information

Table 3. Ordering information

Type number	Package		Version
	Name	Description	
BAS116H	-	plastic surface-mounted package; 2 leads	SOD123F

4. Marking

Table 4. Marking codes

Type number	Marking code
BAS116H	B1

5. Limiting values

Table 5. Limiting values

In accordance with the Absolute Maximum Rating System (IEC 60134).

Symbol	Parameter	Conditions	Min	Max	Unit
V_{RRM}	repetitive peak reverse voltage		-	85	V
V_R	reverse voltage		-	75	V
I_F	forward current		[1][2]	215	mA
I_{FRM}	repetitive peak forward current		-	500	mA
I_{FSM}	non-repetitive peak forward current	square wave	[3]		
		$t_p = 1 \mu\text{s}$	-	4	A
		$t_p = 1 \text{ms}$	-	1	A
		$t_p = 1 \text{s}$	-	0.5	A
P_{tot}	total power dissipation	$T_{amb} \leq 25 \text{ }^\circ\text{C}$	[1][4] [5]	375	mW
T_j	junction temperature		-	150	$^\circ\text{C}$
T_{amb}	ambient temperature		-65	+150	$^\circ\text{C}$
T_{stg}	storage temperature		-65	+150	$^\circ\text{C}$

[1] Device mounted on an FR4 PCB, single-sided copper, tin-plated and standard footprint.

[2] Pulse test: $t_p \leq 300 \mu\text{s}$; $\delta \leq 0.02$.

[3] $T_j = 25 \text{ }^\circ\text{C}$ prior to surge.

[4] Reflow soldering is the only recommended soldering method.

[5] Soldering point of cathode tab.

6. Thermal characteristics

Table 6. Thermal characteristics

Symbol	Parameter	Conditions	Min	Typ	Max	Unit	
$R_{th(j-a)}$	thermal resistance from junction to ambient	in free air	[1][2]	-	-	330	K/W
$R_{th(j-sp)}$	thermal resistance from junction to solder point		[3]	-	-	70	K/W

[1] Device mounted on an FR4 PCB, single-sided copper, tin-plated and standard footprint.

[2] Reflow soldering is the only recommended soldering method.

[3] Soldering point of cathode tab.

7. Characteristics

Table 7. Characteristics

$T_{amb} = 25\text{ °C}$ unless otherwise specified.

Symbol	Parameter	Conditions	Min	Typ	Max	Unit
V_F	forward voltage		[1]			
		$I_F = 1\text{ mA}$	-	-	0.90	V
		$I_F = 10\text{ mA}$	-	-	1.00	V
		$I_F = 50\text{ mA}$	-	-	1.10	V
		$I_F = 150\text{ mA}$	-	-	1.25	V
I_R	reverse current	$V_R = 75\text{ V}$	-	0.003	5.0	nA
		$V_R = 75\text{ V}; T_j = 150\text{ °C}$	-	3	80.0	nA
C_d	diode capacitance	$V_R = 0\text{ V}; f = 1\text{ MHz}$	-	2	-	pF
t_{rr}	reverse recovery time		[2]	0.8	3.0	μs

[1] Pulse test: $t_p \leq 300\text{ }\mu\text{s}$; $\delta \leq 0.02$.

[2] When switched from $I_F = 10\text{ mA}$ to $I_R = 10\text{ mA}$; $R_L = 100\text{ }\Omega$; measured at $I_R = 1\text{ mA}$.

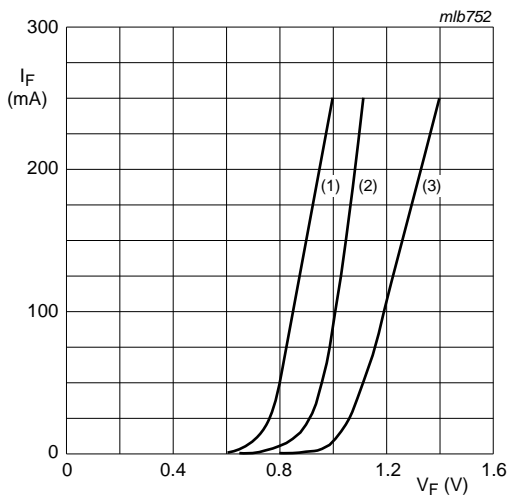

- (1) $T_{amb} = 150\text{ °C}$; typical values
- (2) $T_{amb} = 25\text{ °C}$; typical values
- (3) $T_{amb} = 25\text{ °C}$; maximum values

Fig 1. Forward current as a function of forward voltage

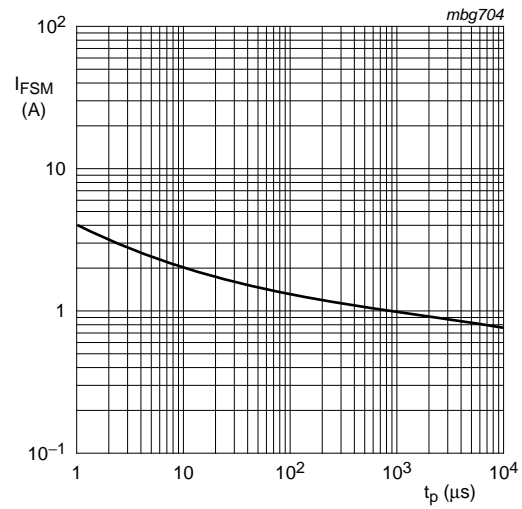

Based on square wave currents
 $T_j = 25\text{ °C}$; prior to surge

Fig 2. Non-repetitive peak forward current as a function of pulse duration; maximum values

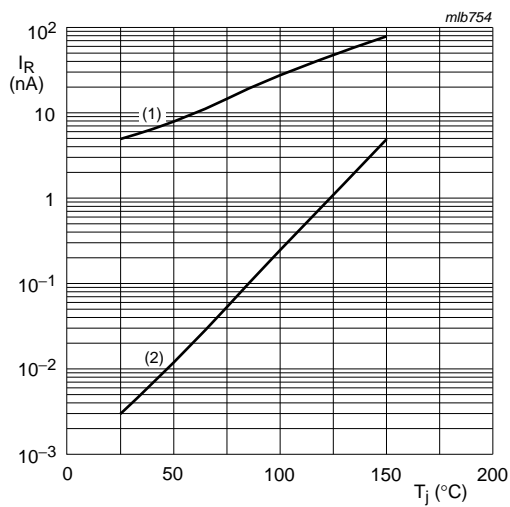

- $V_R = 75\text{ V}$
- (1) Maximum values
 - (2) Typical values

Fig 3. Reverse current as a function of junction temperature

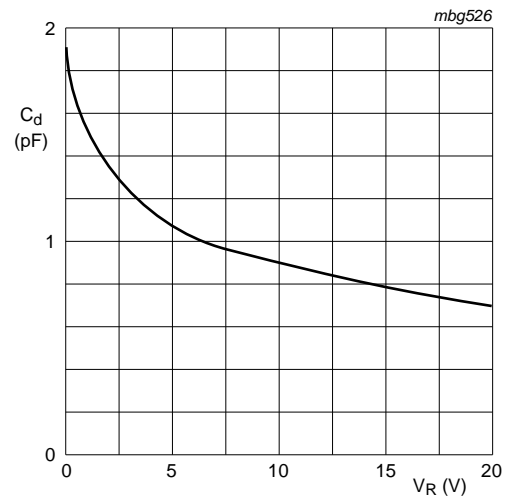

$T_{amb} = 25\text{ °C}$; $f = 1\text{ MHz}$

Fig 4. Diode capacitance as a function of reverse voltage; typical values

8. Test information

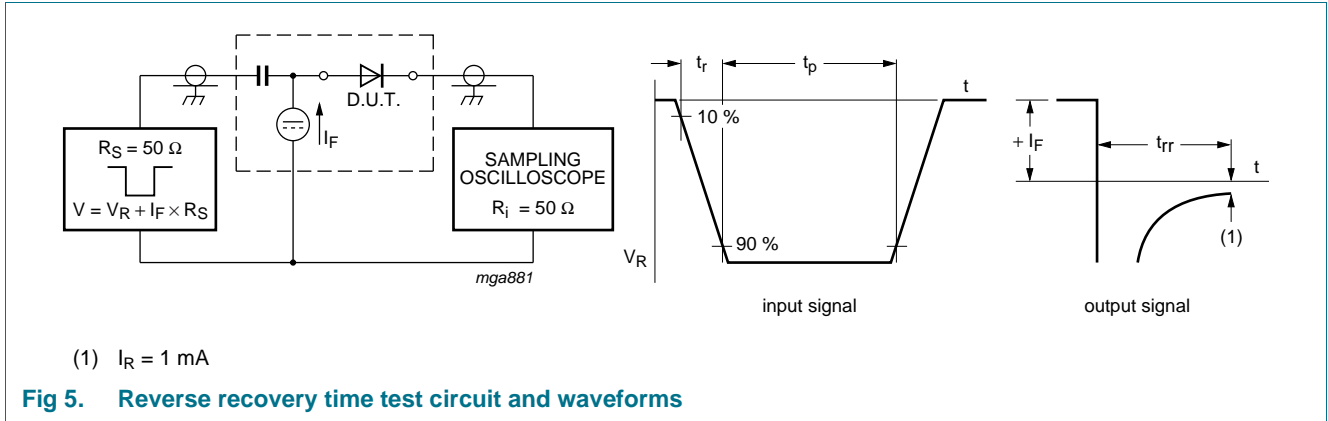

8.1 Quality information

This product has been qualified in accordance with the Automotive Electronics Council (AEC) standard *Q101 - Stress test qualification for discrete semiconductors*, and is suitable for use in automotive applications.

9. Package outline

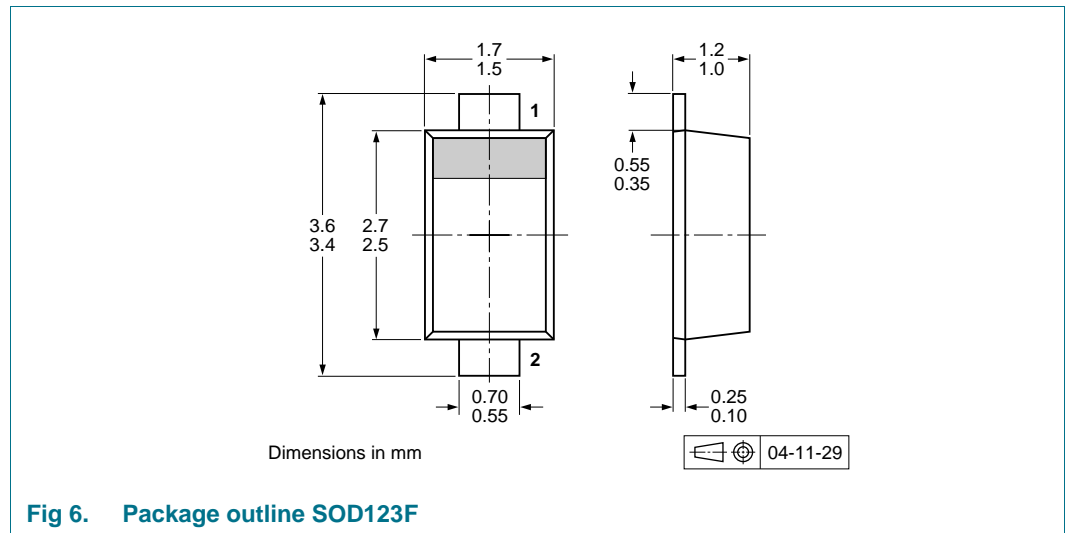

10. Packing information

Table 8. Packing methods

The -xxx numbers are the last three digits of the 12NC ordering code.^[1]

Type number	Package	Description	Packing quantity	
			3000	10000
BAS116H	SOD123F	4 mm pitch, 8 mm tape and reel	-115	-135

[1] For further information and the availability of packing methods, see [Section 14](#).

12. Revision history

Table 9. Revision history

Document ID	Release date	Data sheet status	Change notice	Supersedes
BAS116H v.3	20110531	Product data sheet	-	BAS116H v.2
Modifications:		<ul style="list-style-type: none">• Section 1 "Product profile": updated.• Table 5 and 6: updated.• Table 7: V_F values changed from mV to V.• Figure 2: updated.• Section 8.1 "Quality information": added.• Figure 7: updated.• Section 13 "Legal information": updated.		
BAS116H v.2	20091214	Product data sheet	-	BAS116H v.1
BAS116H v.1	20050411	Product data sheet	-	-

13. Legal information

13.1 Data sheet status

Document status ^{[1][2]}	Product status ^[3]	Definition
Objective [short] data sheet	Development	This document contains data from the objective specification for product development.
Preliminary [short] data sheet	Qualification	This document contains data from the preliminary specification.
Product [short] data sheet	Production	This document contains the product specification.

[1] Please consult the most recently issued document before initiating or completing a design.

[2] The term 'short data sheet' is explained in section "Definitions".

[3] The product status of device(s) described in this document may have changed since this document was published and may differ in case of multiple devices. The latest product status information is available on the Internet at URL <http://www.nxp.com>.

13.2 Definitions

Draft — The document is a draft version only. The content is still under internal review and subject to formal approval, which may result in modifications or additions. NXP Semiconductors does not give any representations or warranties as to the accuracy or completeness of information included herein and shall have no liability for the consequences of use of such information.

Short data sheet — A short data sheet is an extract from a full data sheet with the same product type number(s) and title. A short data sheet is intended for quick reference only and should not be relied upon to contain detailed and full information. For detailed and full information see the relevant full data sheet, which is available on request via the local NXP Semiconductors sales office. In case of any inconsistency or conflict with the short data sheet, the full data sheet shall prevail.

Product specification — The information and data provided in a Product data sheet shall define the specification of the product as agreed between NXP Semiconductors and its customer, unless NXP Semiconductors and customer have explicitly agreed otherwise in writing. In no event however, shall an agreement be valid in which the NXP Semiconductors product is deemed to offer functions and qualities beyond those described in the Product data sheet.

13.3 Disclaimers

Limited warranty and liability — Information in this document is believed to be accurate and reliable. However, NXP Semiconductors does not give any representations or warranties, expressed or implied, as to the accuracy or completeness of such information and shall have no liability for the consequences of use of such information.

In no event shall NXP Semiconductors be liable for any indirect, incidental, punitive, special or consequential damages (including - without limitation - lost profits, lost savings, business interruption, costs related to the removal or replacement of any products or rework charges) whether or not such damages are based on tort (including negligence), warranty, breach of contract or any other legal theory.

Notwithstanding any damages that customer might incur for any reason whatsoever, NXP Semiconductors' aggregate and cumulative liability towards customer for the products described herein shall be limited in accordance with the *Terms and conditions of commercial sale* of NXP Semiconductors.

Right to make changes — NXP Semiconductors reserves the right to make changes to information published in this document, including without limitation specifications and product descriptions, at any time and without notice. This document supersedes and replaces all information supplied prior to the publication hereof.

Suitability for use — NXP Semiconductors products are not designed, authorized or warranted to be suitable for use in life support, life-critical or safety-critical systems or equipment, nor in applications where failure or

malfunction of an NXP Semiconductors product can reasonably be expected to result in personal injury, death or severe property or environmental damage. NXP Semiconductors accepts no liability for inclusion and/or use of NXP Semiconductors products in such equipment or applications and therefore such inclusion and/or use is at the customer's own risk.

Applications — Applications that are described herein for any of these products are for illustrative purposes only. NXP Semiconductors makes no representation or warranty that such applications will be suitable for the specified use without further testing or modification.

Customers are responsible for the design and operation of their applications and products using NXP Semiconductors products, and NXP Semiconductors accepts no liability for any assistance with applications or customer product design. It is customer's sole responsibility to determine whether the NXP Semiconductors product is suitable and fit for the customer's applications and products planned, as well as for the planned application and use of customer's third party customer(s). Customers should provide appropriate design and operating safeguards to minimize the risks associated with their applications and products.

NXP Semiconductors does not accept any liability related to any default, damage, costs or problem which is based on any weakness or default in the customer's applications or products, or the application or use by customer's third party customer(s). Customer is responsible for doing all necessary testing for the customer's applications and products using NXP Semiconductors products in order to avoid a default of the applications and the products or of the application or use by customer's third party customer(s). NXP does not accept any liability in this respect.

Limiting values — Stress above one or more limiting values (as defined in the Absolute Maximum Ratings System of IEC 60134) will cause permanent damage to the device. Limiting values are stress ratings only and (proper) operation of the device at these or any other conditions above those given in the Recommended operating conditions section (if present) or the Characteristics sections of this document is not warranted. Constant or repeated exposure to limiting values will permanently and irreversibly affect the quality and reliability of the device.

Terms and conditions of commercial sale — NXP Semiconductors products are sold subject to the general terms and conditions of commercial sale, as published at <http://www.nxp.com/profile/terms>, unless otherwise agreed in a valid written individual agreement. In case an individual agreement is concluded only the terms and conditions of the respective agreement shall apply. NXP Semiconductors hereby expressly objects to applying the customer's general terms and conditions with regard to the purchase of NXP Semiconductors products by customer.

No offer to sell or license — Nothing in this document may be interpreted or construed as an offer to sell products that is open for acceptance or the grant, conveyance or implication of any license under any copyrights, patents or other industrial or intellectual property rights.

Export control — This document as well as the item(s) described herein may be subject to export control regulations. Export might require a prior authorization from national authorities.

Quick reference data — The Quick reference data is an extract of the product data given in the Limiting values and Characteristics sections of this document, and as such is not complete, exhaustive or legally binding.

13.4 Trademarks

Notice: All referenced brands, product names, service names and trademarks are the property of their respective owners.

14. Contact information

For more information, please visit: <http://www.nxp.com>

For sales office addresses, please send an email to: salesaddresses@nxp.com

15. Contents

1	Product profile	1
1.1	General description	1
1.2	Features and benefits	1
1.3	Applications	1
1.4	Quick reference data	1
2	Pinning information	1
3	Ordering information	2
4	Marking	2
5	Limiting values	2
6	Thermal characteristics	3
7	Characteristics	3
8	Test information	5
8.1	Quality information	5
9	Package outline	5
10	Packing information	5
11	Soldering	6
12	Revision history	7
13	Legal information	8
13.1	Data sheet status	8
13.2	Definitions	8
13.3	Disclaimers	8
13.4	Trademarks	9
14	Contact information	9
15	Contents	10

Please be aware that important notices concerning this document and the product(s) described herein, have been included in section 'Legal information'.

© NXP B.V. 2011.

All rights reserved.

For more information, please visit: <http://www.nxp.com>

For sales office addresses, please send an email to: salesaddresses@nxp.com

Date of release: 31 May 2011

Document identifier: BAS116H