

Firmware Version V1.00

TMC5031-EVAL EVALUATION BOARD MANUAL



TMC5031-EVAL

Evaluation Board for TMC5031
Motor Controller / Driver for
Two Phase Stepper Motors
Up to 2x 0.7A RMS/ +5.5V... 16V DC
USB, RS232, and SPI
2x Ref. Switch Input per Axis

UNIQUE FEATURES:



TABLE OF CONTENTS

1	Features.....	3
2	Order Codes.....	4
3	Hardware.....	5
3.1	Mechanical and Electrical Interfacing.....	5
3.1.1	Size of TM5031-EVAL and Mounting Holes.....	5
3.1.2	Overview of Connectors.....	6
3.1.3	Push Buttons: Reference Switches of Motor 2.....	9
3.1.4	LEDs.....	9
4	Operational Ratings.....	10
5	Getting Started – How to Connect the Board.....	11
5.1	Installing the Virtual Com Port for USB Interface.....	12
6	Evaluation Software.....	13
6.1	Starting the Evaluation Software.....	13
6.2	Main Dialogues.....	14
6.2.1	The Jog Tab.....	14
6.2.2	The Ramp Generator Tab.....	14
6.3	Basic Functions.....	15
6.3.1	Load / Save / Export Settings.....	15
6.3.2	Options Menu.....	15
6.3.3	Get Firmware Version.....	15
6.3.4	Reset to Factory Defaults.....	15
6.4	Special Dialogues.....	16
6.4.1	Motor Current Settings Dialogue.....	16
6.4.2	Ramp Generator Features Dialogue.....	17
6.4.3	coolStep Dialogue.....	21
6.4.4	Chopper Configuration Dialogue.....	22
6.4.5	Driver Status Information.....	24
6.4.6	Microstep Wave Dialogue.....	25
6.4.7	Global Configuration Dialogue.....	28
6.4.8	All Registers Dialogue.....	29
7	Life Support Policy.....	30
8	Revision History.....	31
8.1	Firmware Revision.....	31
8.2	Document Revision.....	31
9	References.....	31

1 Features

The TMC5031 evaluation board is designed for evaluating all features of the TMC5031 controller/driver IC. The STM32F ARM Cortex-M3 microcontroller is used to control the TMC5031. The FLASH memory of the microcontroller contains a program which configures the controller/driver chip and controls the communication with the PC via the USB interface and the RS232 interface.

MAIN CHARACTERISTICS

Integrated motion controller

- Motion profile calculation in real-time
- On the fly alteration of motor parameters (e.g. position, velocity, acceleration)

Integrated motor driver for two motors

- Up to 256 microsteps per full step
- High-efficient operation, low power dissipation
- Dynamic current control
- stallGuard2 feature for stall detection
- coolStep feature for reduced power consumption and heat dissipation
- spreadCycle chopper or classic chopper

Electrical data

- Motor current: up to 2x 0.7A RMS nominal motor current
- Supply voltage: +5.5V... +16V DC operating voltage

Interfaces

- RS232
- USB (type B)
- Native SPI™ of the TMC5031
- 2x reference switch inputs per axis
- Access to all signals of the TMC5031

Motor type

- Two phase bipolar stepper motors

Safety features

- Overcurrent
- Short to GND
- Undervoltage protection
- Integrated diagnostics

Software

- PC demonstration software allowing access to all registers
- Graphical view of position counter and motor velocity
- Special tools for stallGuard2, coolStep, and chopper adjustments

TRINAMICs UNIQUE FEATURES

stallGuard2™ stallGuard2 is a high-precision sensorless load measurement using the back EMF on the coils. It can be used for stall detection as well as other uses at loads below those which stall the motor. The stallGuard2 measurement value changes linearly over a wide range of load, velocity, and current settings. At maximum motor load, the value goes to zero or near to zero. This is the most energy-efficient point of operation for the motor.

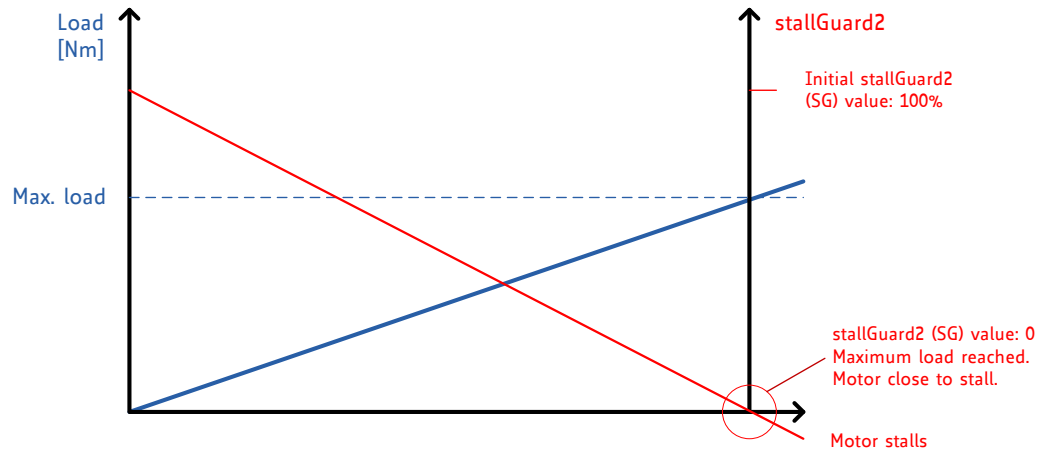

Figure 1.1 stallGuard2 load measurement SG as a function of load

coolStep™ coolStep is a load-adaptive automatic current scaling based on the load measurement via stallGuard2 adapting the required current to the load. Energy consumption can be reduced by as much as 75%. coolStep allows substantial energy savings, especially for motors which see varying loads or operate at a high duty cycle. Because a stepper motor application needs to work with a torque reserve of 30% to 50%, even a constant-load application allows significant energy savings because coolStep automatically enables torque reserve when required. Reducing power consumption keeps the system cooler, increases motor life, and allows reducing cost.

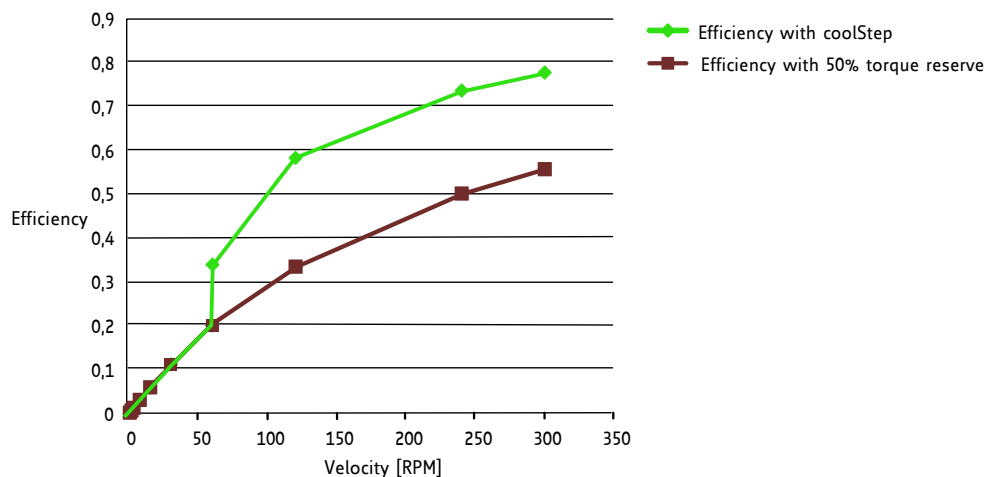

Figure 1.2 Energy efficiency example with coolStep

2 Order Codes

Order code	Description	Size of unit [mm ³]
TMC5031-EVAL	Evaluation board for TMC5031 two phase motor controller/driver	85 x 55 x 13.5

Table 2.1 Order codes

3 Hardware

3.1 Mechanical and Electrical Interfacing

3.1.1 Size of TMC5031-EVAL and Mounting Holes

The board dimensions are 85mm x 55mm. Maximum component height (above PCB level) without mating connectors is 13.5mm. There are four mounting holes suitable for M3 screws.

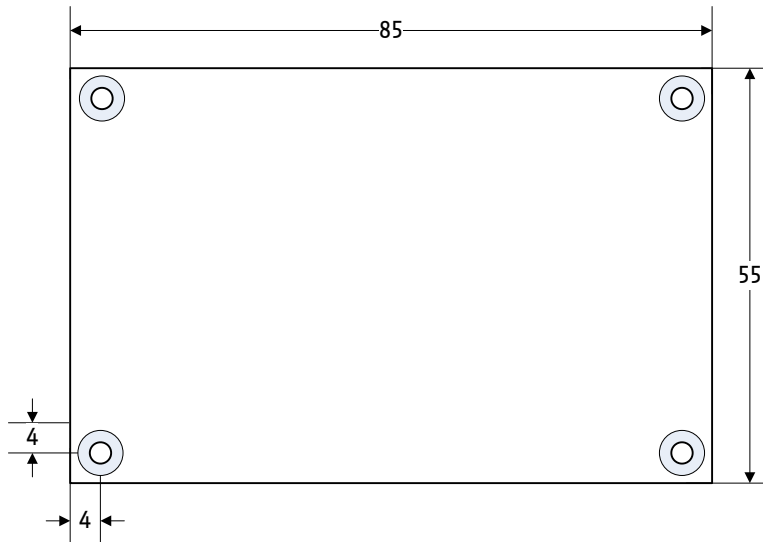

Figure 3.1 TMC5031-EVAL dimensions

3.1.2 Overview of Connectors

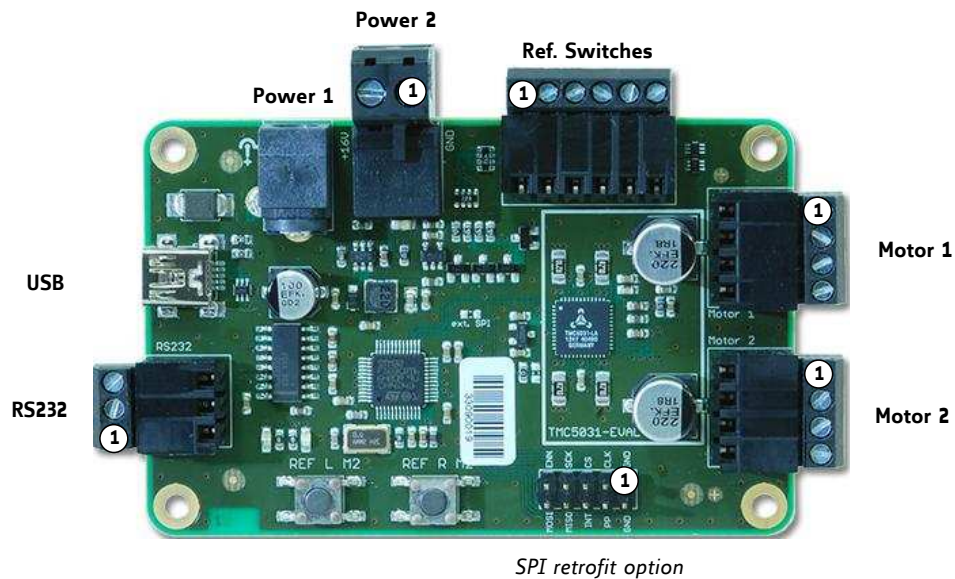

Figure 3.2 Connectors of TMC5031-EVAL

CONNECTORS OF TMC5031-EVAL

Label (Key)	Connector type	Mating connector type
Power 1 (X15)	Switchcraft Power Jack header RAPC722X	Switchcraft two-conductor Power Jack, e.g. S760K
Power 2 (X3)	RIA 330-02, 2 pol., 5mm pitch, shrouded header	RIA 349-2, screw type terminal block, pluggable, centerline 5 mm / 0.197 inches, wire entry parallel to plug direction
Motor 1 (X2) Motor 2 (X1)	RIA 182-04, 4 pol., 3.5mm pitch, header	RIA 169-04, screw type terminal block, pluggable, centerline 3.5 mm / 0.138 inches, wire entry parallel to plug direction
Reference switches (X3)	RIA 182-06, 6 pol., 3.5mm pitch, header	RIA 169-06, screw type terminal block, pluggable, centerline 3.5 mm / 0.138 inches, wire entry parallel to plug direction
USB (X11)	Mini USB, type B, 4 pol., female	Mini USB, type B, 4 pol., male
RS232 (X12)	RIA 182-03, 3 pol., 3.5mm pitch, header	RIA 169-03, screw type terminal block, pluggable, centerline 3.5 mm / 0.138 inches, wire entry parallel to plug direction

Table 3.1 Connectors

3.1.2.1 Power Jack Connector (1)

This jack connector fits for commercially available power supply units for e.g. 12V DC.

Pin	Label	Description
1	GND	Power supply and signal ground
2	GND	Power supply and signal ground
3	+UB	Supply voltage: +5.5V... 18V DC

Table 3.2 Power connector 1

3.1.2.2 RIA Power Connector (2)

Pin	Label	Description
1	GND	Power supply and signal ground
2	+VCC	Operational voltage: +5.5... 18V DC

Table 3.3 Power connector 2

3.1.2.3 Motor Connector Axis 1

Pin	Label	Description
1	O1A1	Motor coil A
2	O1A2	Motor coil A
3	O1B1	Motor coil B
4	O1B2	Motor coil B

Table 3.4 Connector for Step/Dir signals

3.1.2.4 Motor Connector Axis 2

Per default firmware setting, the direction of motor 2 is reversed to compensate for reversed pinning of the motor connector. The following table shows the real pin assignment on the evaluation board without reversing the motor direction.

Pin	Label	Description
1	O2B2	Motor coil B
2	O2B1	Motor coil B
3	O2A2	Motor coil A
4	O2A1	Motor coil A

Table 3.5 Connector for Step/Dir signals

3.1.2.5 USB Connector

Pin	Label	Description
1	+5V	+5V supply from host
2	USB-	Differential USB bus
3	USB+	Differential USB bus
4	GND	System and module ground

Table 3.6 USB connector

3.1.2.6 RS232 Connector

Pin	Label	Description
1	GND	RS232 signal and system ground
2	TXD	Transmitted data line
3	RXD	Received data line

Table 3.7 RS232 connector

3.1.2.7 Reference Switch Connector

Pin	Label	Description
1	GND	System and module ground
2	REF_R1	Right reference switch axis 1
3	REF_L1	Left reference switch axis 1
4	REF_R2	Right reference switch axis 2
5	REF_L2	Left reference switch axis 2
6	+5V	+5V output

Table 3.8 Reference Switch connector

3.1.2.8 SPI and Interrupts (*Measurement Points and Retrofit Option*)

The SPI connector is not assembled, but can be retrofitted in case an external microcontroller should be used. Typically, these pins are used for measurements concerning SPI interface and interrupts (INT and PP).



Figure 3.3 Example for SPI connector assembly (header 2x5)

Pin	Label	Description
1	GND	System and module ground
2	GND	System and module ground
3	CLK	CLK input
4	PP	Tristate position compare output for motor 1 of the TMC5031
5	CS	Chip select input of SPI interface
6	INT	Tristate interrupt output based on ramp generator flags 4, 5, 6 & 7.
7	SCK	Serial clock input of SPI interface
8	SPI_MISO	Serial data input
9	DRV_ENN	Enable (not) input for drivers (tie to GND). Switches off all motor outputs (set high for disable).
10	SPI_MOSI	Serial data output

Table 3.9 SPI and interrupt signals for measurements or connection of external device

3.1.2.8.1 Connecting an External Microcontroller

To enable communication via SPI for connecting an external microcontroller, it is necessary to first solder a 0Ω resistor on the board. A 3V3 supply (VCCIO) for the external microcontroller is available.

Solder 0Ω resistor here.

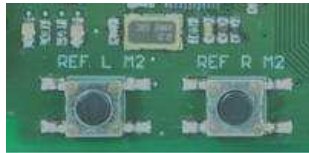

Figure 3.4 Retrofit option: SPI

3.1.3 Push Buttons: Reference Switches of Motor 2

The TMC5031-EVAL offers two push buttons for the reference switches of motor 2. As long as a button is pushed the related reference switch of motor 2 is active.

Note that the *ramp generator features* dialogue of the evaluation software includes a *switch mode tab* which shows the status of switches. The flags can be polled continuously.



REF_L2 REF_R2

Figure 3.5 Push buttons

Label	Description
REF L M2	This button is connected to pin 26 (REF_L2) of the TMC5031.
REF R M2	This button is connected to pin 25 (REF_R2) of the TMC5031.

Table 3.10 Push buttons

3.1.4 LEDs

The TMC5031-EVAL has three LEDs. Two of them indicate the normal operation of the board: the green LED1 glows to show that the +5V supply is available. LED2 flashes constantly to indicate the 16MHz heartbeat of the board. LED3 does not have a specific function and can be used customer specific.

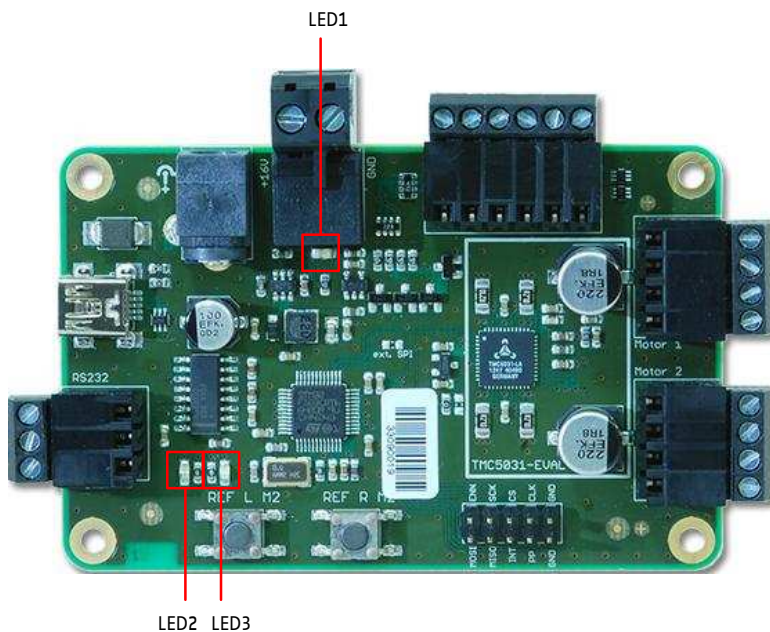

Figure 3.6 LEDs

LEDs of TMC5031-EVAL

Label	Color	Description
LED1	green	Glows, if +5V is available.
LED2	red	Heartbeat of the module. Flashes constantly per default.
LED3	red	Can be used customer specific.

Table 3.11 LEDs

4 Operational Ratings

The operational ratings shown below should be used as design values. The maximum power supply current depends on the used motors and the supply voltage.

Do not exceed the maximum values during operation! Otherwise the driver will be damaged!

Symbol	Parameter	Min	Typ	Max	Unit
VCC	Power supply voltage for operation	-0.5	12	18	V
VCCIO	Digital power supply (for external microcontroller)		3.3		V
+5V	Output of internal switch regulator		5	5.1	V
I_{SUPPLY}	Power supply current		0.2... 0.7	1.1	A
T_{ENV}	Environment temperature at rated current (no forced cooling required)		20°C		°C

Table 4.1 General operational ratings of the module

5 Getting Started – How to Connect the Board

YOU NEED

- Evaluation board with stepper motor (e.g. QSH4218)
- USB interface or RS232 interface
- Nominal supply voltage +12V DC (+5.5... +16V DC)
- TMC50xx-EVAL software and PC
- Cables for interface, motor, and power

PRECAUTIONS

- Do not mix up connections or short-circuit pins.
- Avoid bounding I/O wires with motor wires.
- Do not exceed the maximum power supply of +18V DC!
- Do not connect or disconnect the motor while powered!
- START WITH POWER SUPPLY OFF!

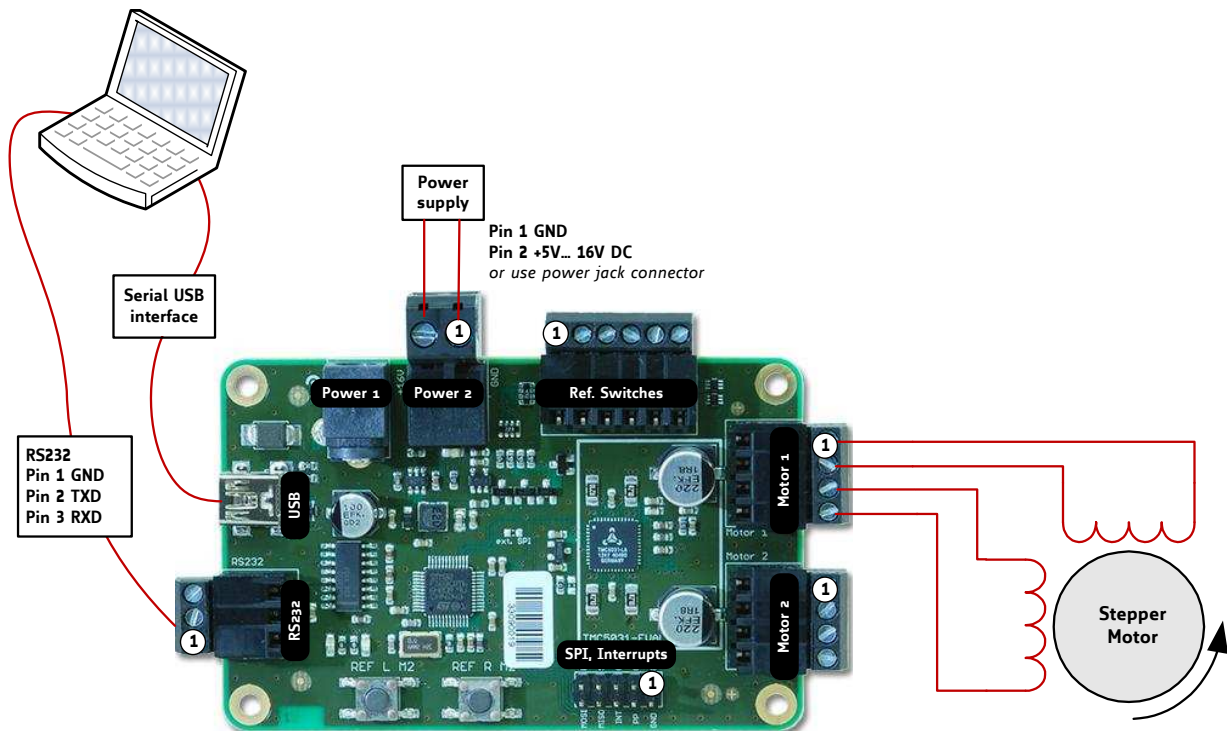

Figure 5.1 Getting started

STARTING UP

1. *USB interface:* the evaluation board software TMC50xx-EVAL is designed to guide you through the installation of a virtual com port for the USB interface. Refer to chapter 5.1 for further information.
RS232 interface: connect RS232 interface to interface converter and afterwards to your PC or connect it directly to your PC, if the RS232 interface is provided.
2. Connect one or two motors to the specific connectors.
3. Connect the power supply of module.
4. Turn power ON. The red LED for heartbeat flashes and the green LED for power glows. The motor is powered but in standstill now. *If this does not occur, turn power OFF and check your connections and power supply!*
5. Download and open the file TMC50xx-EVAL. Now you can start examinations. Note: if you are using the USB interface, the software will do the installation of the virtual comport configuration file now.

5.1 Installing the Virtual Com Port for USB Interface

1. Start the *TMC50xx-EVAL.exe* application with a double click.
2. First, you will be asked, which module you like to connect. Choose the *TMC5031-EVAL*.
3. Then, a hint will appear on the screen. If the module is not already connected, plug it, power it on, and click *OK*.

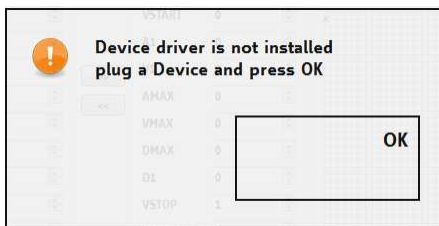

Figure 5.2 Hint related to device driver installation

4. Now, the software will search and install the configuration file.

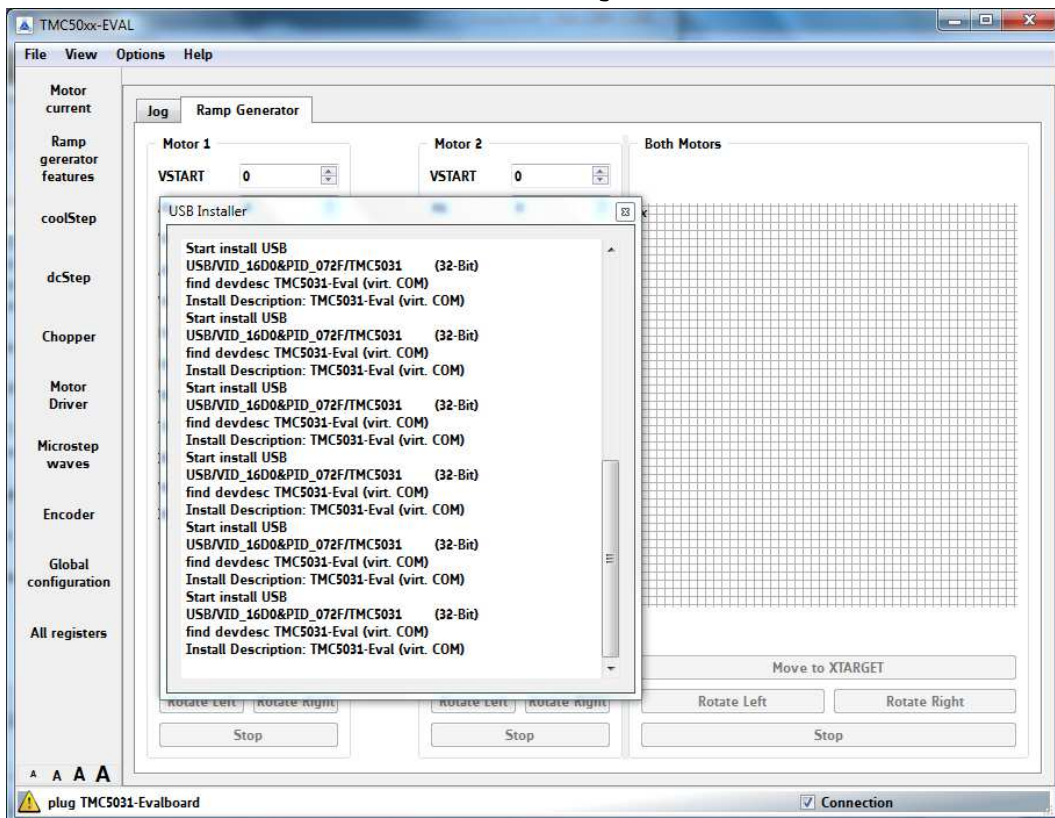

Figure 5.3 Install USB driver

5. You will be asked if you really like to install the unknown file. Answer yes to install it.
6. As soon as the installation of the virtual com port is completed, start your tests.

In case this does not work, install the file using the system control of your PC.

6 Evaluation Software

The evaluation software *TMC50xx-EVAL.exe* is intended for customers who design own PCBs with the TMC5031. In order to understand the settings, the TMC5031 datasheet needs to be referenced. The software is designed for adjusting and testing all settings of the TMC5031 by allowing direct register access. Optimized settings can be stored and exported.

6.1 Starting the Evaluation Software

- Download the file *TMC50xx-EVAL.exe* from our website www.trinamic.com. The software is a PC application running under Windows XP, Vista, Windows 7, and Windows 8 (Windows 3.x is not supported).
- Double-click the file *TMC50xx-EVAL.exe*.
- If you are testing just one module type, click *Remember me*. This way, the software will skip this part of the program next time.
- Choose your module type.
- Plug the evaluation board, if it is not connected yet.



Figure 6.1 Choose module

- Click *Connection* to connect your board. Now, you can start your tests.

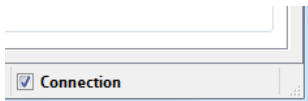

Figure 6.2 Connect module

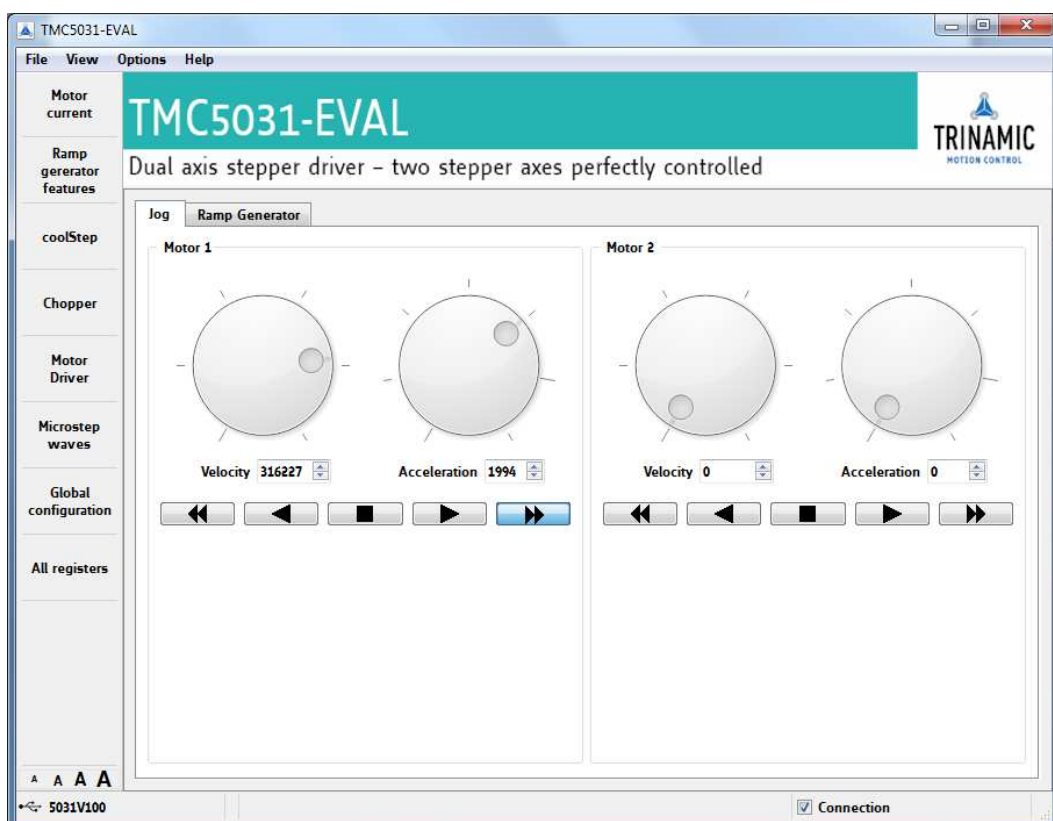

Figure 6.3 Jog tab

6.2 Main Dialogues

The evaluation software offers two main dialogues: the *jog dialogue* and the *ramp generator dialogue* on the next tab. Both dialogues offer separate data input fields for motor 1 and motor 2.

6.2.1 The Jog Tab

Use the rotary control switches with the left key or the small wheel of your computer mouse. Thus, velocity and acceleration for each motor can be set and/or changed. Both values increase/decrease according to a logarithmic function.

There are five keys for each motor. The keys with just one arrow are push-buttons. A motor moves as long as one of these is pressed (using the left mouse key). Acceleration and deceleration will always be adequate to your settings (or default settings), which can be read out using the *all registers dialogue*.



Figure 6.4 Jog tab keys for moving a motor

6.2.2 The Ramp Generator Tab

The design of the ramp generator tab correlates to the jog tab. Ramp generator settings for each motor can be done independently from the other motor. With this, comparisons of different settings are quite easy. The two motors can be driven simultaneously using the buttons for both below the diagram. All values can be calibrated on the fly while a drive is still active.

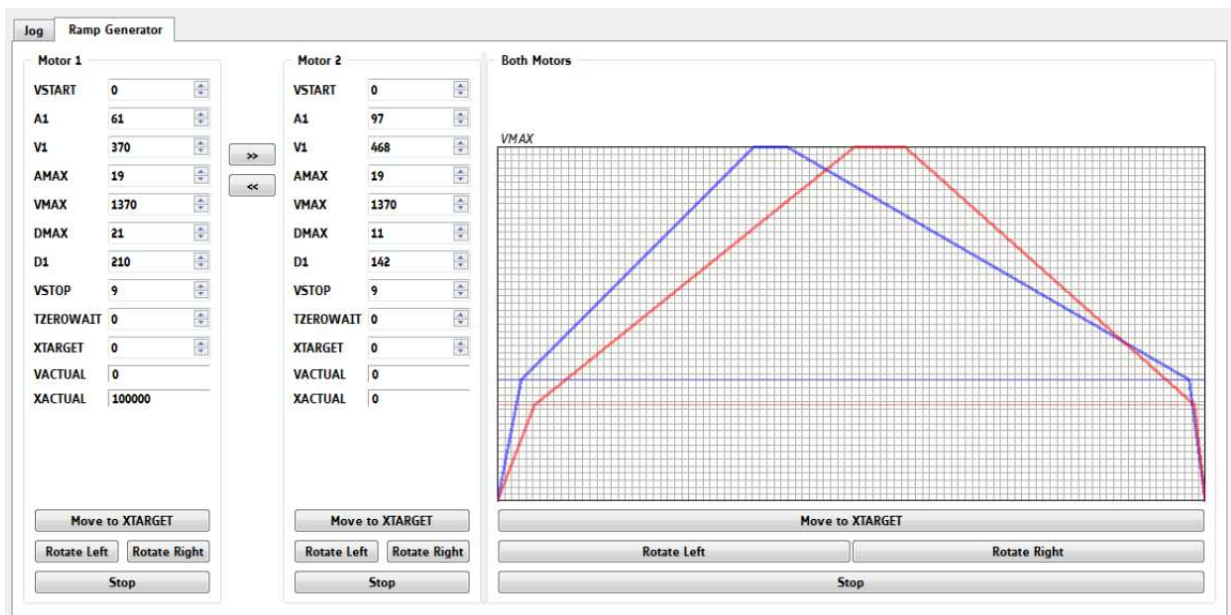

Figure 6.5 Ramp generator tab

A complete set of ramp generator values can be copied to the input data area of the other motor by clicking the buttons with two arrows. Afterwards the value sets can be adjusted individually for each motor.



Figure 6.6 Copy value set

6.3 Basic Functions

6.3.1 Load / Save / Export Settings

Module settings can be loaded, saved, and exported. Click *File* on top menu and choose the desired action. Note that it is not possible to store settings permanently on the board.



Figure 6.7 Load / save / export settings.

6.3.2 Options Menu

There are two special options related to the handling of this software tool:

- If you choose *Extra Style*, the software surface will be colored differently.
- *Remember Module* can be set, if you are always working with the same module. If you intend to test another IC evaluation board, it is necessary to remove the remember module command!

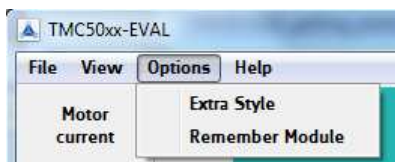

Table 6.1 Options menu

6.3.3 Get Firmware Version

To read out the firmware version, click *Help* on top menu and afterwards *About*. Now, the TMC50xx-EVAL software shows the version number and the build-ID.

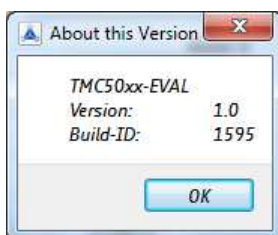

Figure 6.8 Firmware Version

6.3.4 Reset to Factory Defaults

Each time, the evaluation board is powered off and on again it will be reset to factory defaults.

6.4 Special Dialogues

Click *view* on top menu or the specific fields on the left side of the main window to open up dialogues for special settings. Note that *dcStep* and *encoder* are not provided by the TMC5031.

THE FOLLOWING SPECIAL DIALOGUES ARE PROVIDED:

- Motor current settings
- Ramp generator features
- coolStep
- Chopper
- Motor driver
- Microstep waves
- Global configuration
- All registers

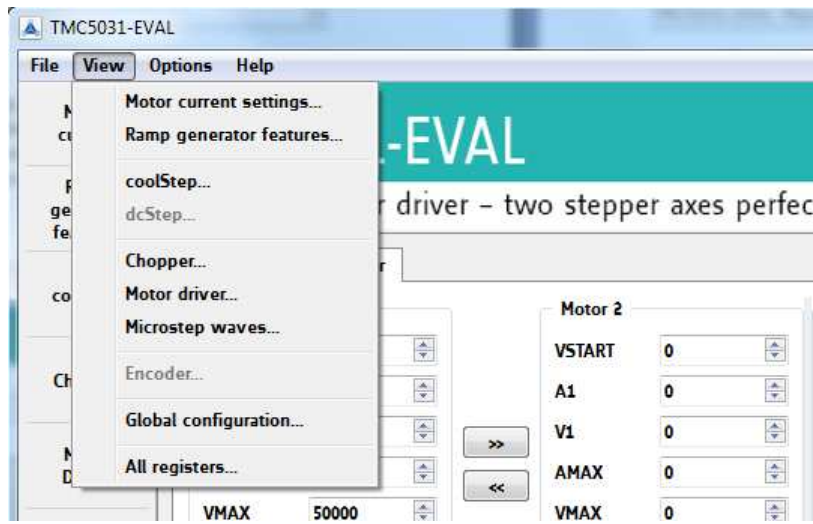
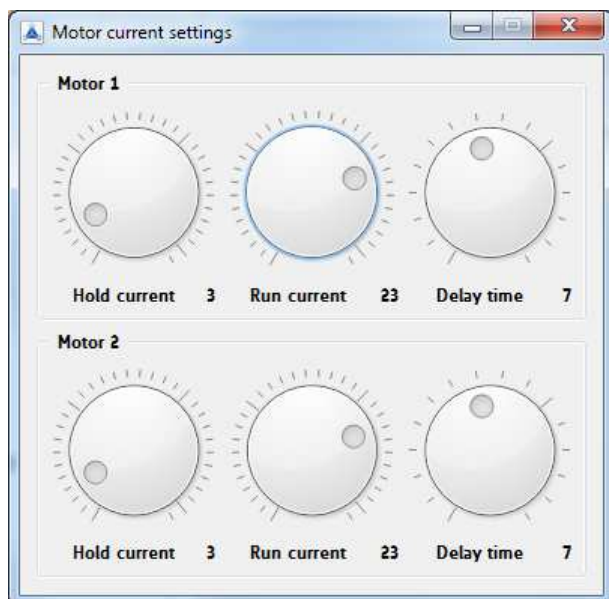

Figure 6.9 View dialogues

6.4.1 Motor Current Settings Dialogue

This dialogue makes the evaluation of the TMC5031 more comfortable. Motor current settings can be tried out by using rotary control switches.



NOTE

Exact values can be read out and changed using the *all registers* dialogue.

Figure 6.10 Motor current settings

6.4.2 Ramp Generator Features Dialogue

This dialogue offers two tabs: the ramp status tab and the switch mode tab. These tabs correlate with each other.

6.4.2.1 Ramp Status Tab

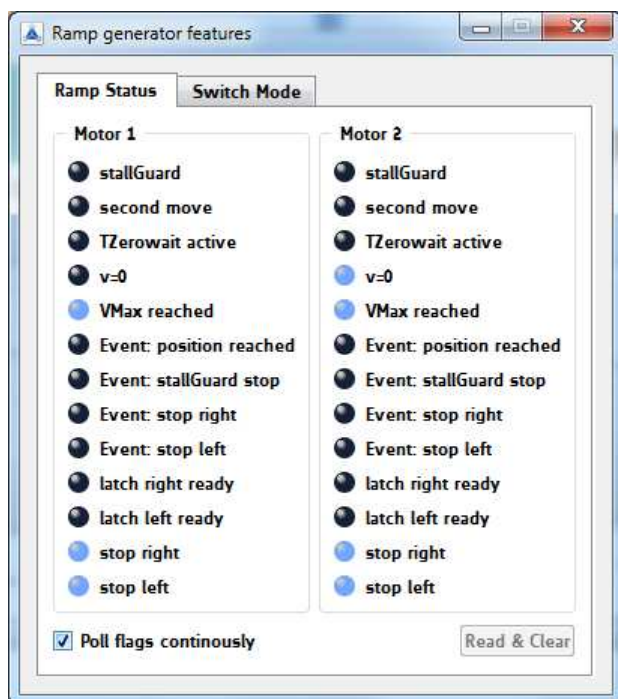

Ramp status flags can be polled continuously or on demand. This status tab is designed to read out the RAMP_STAT register of the TMC5031. Blue marked flags are set.

If you use the push buttons for the reference switches of motor 2 on the evaluation board, the status can be read out here.

Figure 6.11 Ramp and reference switch status flags

0x35, 0x55: RAMP_STAT – RAMP AND REFERENCE SWITCH STATUS REGISTER OF TMC5031			
R/W	Bit	Name	Comment
R	13	<i>status_sg</i>	1: Signals an active stallGuard2 input from the coolStep driver, if enabled. <i>Hint:</i> When polling this flag, stall events may be missed – activate <i>sg_stop</i> to be sure not to miss the stall event.
R+C	12	<i>second_move</i>	1: Signals that the automatic ramp requires moving back in the opposite direction, e.g. due to on-the-fly parameter change (Flag is cleared upon reading)
R	11	<i>t_zerowait_active</i>	1: Signals, that <i>T_ZEROWAIT</i> is active after a motor stop. During this time, the motor is in standstill.
R	10	<i>vzero</i>	1: Signals, that the actual velocity is 0.
R	9	<i>position_reached</i>	1: Signals, that the target position is reached. This flag becomes set while <i>X_ACTUAL</i> and <i>X_TARGET</i> match.
R	8	<i>velocity_reached</i>	1: Signals, that the target velocity is reached. This flag becomes set while <i>V_ACTUAL</i> and <i>VMAX</i> match.
R+C	7	<i>event_pos_reached</i>	1: Signals, that the target position has been reached (<i>pos_reached</i> becoming active). This bit is ORed to the <i>interrupt output</i> signal. (Flag is cleared upon reading)
R+C	6	<i>event_stop_sg</i>	1: Signals an active StallGuard2 stop event. (Flag is cleared upon reading) This bit is ORed to the <i>interrupt output</i> signal.
R	5	<i>event_stop_r</i>	Signals an active stop right condition due to stop switch. This bit is ORed to the <i>interrupt output</i> signal.

0x35, 0x55: RAMP_STAT – RAMP AND REFERENCE SWITCH STATUS REGISTER OF TMC5031			
R/W	Bit	Name	Comment
	4	<i>event_stop_l</i>	1: Signals an active stop left condition due to stop switch. This bit is ORed to the <i>interrupt output</i> signal.
R+C	3	<i>status_latch_r</i>	1: Latch right ready (enable position latching using <i>SWITCH_MODE</i> settings <i>latch_r_active</i> or <i>latch_r_inactive</i>) This bit is ORed to the <i>interrupt output</i> signal. (Flag is cleared upon reading)
	2	<i>status_latch_l</i>	1: Latch left ready (enable position latching using <i>SWITCH_MODE</i> settings <i>latch_l_active</i> or <i>latch_l_inactive</i>) This bit is ORed to the <i>interrupt output</i> signal. (Flag is cleared upon reading)
R	1	<i>status_stop_r</i>	Reference switch right status (1=active)
	0	<i>status_stop_l</i>	Reference switch left status (1=active)

Table 6.2 RAMP_STAT register

6.4.2.2 Switch Mode Tab

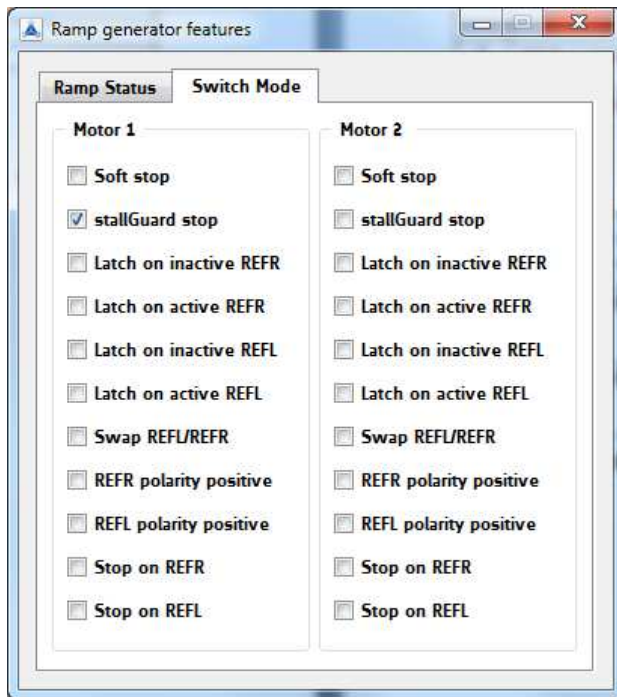

With this tab, the SW_MODE register of the TMC5031 can be adjusted. Just tick the desired function to set it.

NOTE

If *stallGuard stop* is active and the motor stalls, deactivate the stallGuard event before going on with your tests. Otherwise the motor will not rotate.

For a further stallGuard test activate the stallGuard event again.

Figure 6.12 SW_MODE register

0x34, 0x54: SW_MODE – REFERENCE SWITCH AND STALLGUARD2 EVENT CONFIGURATION REGISTER		
Bit	Name	Comment
11	<i>en_softstop</i>	0: Hard stop 1: Soft stop The soft stop mode always uses the deceleration ramp settings <i>DMAX</i> , <i>V1</i> , <i>D1</i> , <i>VSTOP</i> and <i>TZEROWAIT</i> for stopping the motor. A stop occurs when the velocity sign matches the reference switch position (REFL for negative velocities, REFR for positive velocities) and the respective switch stop function is enabled. A hard stop also uses <i>TZEROWAIT</i> before the motor becomes released. <i>Attention: Do not use soft stop in combination with stallGuard2.</i>
10	<i>sg_stop</i>	1: Enable stop by stallGuard2. Disable to release motor after stop event. <i>Attention: Do not enable during motor spin-up, wait until the motor velocity exceeds a certain value, where stallGuard2 delivers a stable result.</i>
9	-	Reserved, set to 0
8	<i>latch_r_inactive</i>	1: Activates latching of the position to <i>XLATCH</i> upon an inactive going edge on the right reference switch input REFR.
7	<i>latch_r_active</i>	1: Activates latching of the position to <i>XLATCH</i> upon an active going edge on the right reference switch input REFR. <i>Hint: Activate latch_r_active to detect any spurious stop event by reading status_latch_r.</i>
6	<i>latch_l_inactive</i>	1: Activates latching of the position to <i>XLATCH</i> upon an inactive going edge on the left reference switch input REFL.
5	<i>latch_l_active</i>	1: Activates latching of the position to <i>XLATCH</i> upon an active going edge on the left reference switch input REFL. <i>Hint: Activate latch_l_active to detect any spurious stop event by reading status_latch_l.</i>
4	<i>swap_lr</i>	1: Swap the left and the right reference switch input

0x34, 0x54: SW_MODE – REFERENCE SWITCH AND STALLGUARD2 EVENT CONFIGURATION REGISTER		
Bit	Name	Comment
3	<i>pol_stop_r</i>	Sets the polarity of the right reference switch input (0=neg., 1=pos.)
2	<i>pol_stop_l</i>	Sets the polarity of the left reference switch input (0=neg., 1=pos.)
1	<i>stop_r_enable</i>	1: Enables automatic motor stop during active right reference switch input <i>Hint:</i> The motor restarts in case the stop switch becomes released.
0	<i>stop_l_enable</i>	1: Enables automatic motor stop during active left reference switch input <i>Hint:</i> The motor restarts in case the stop switch becomes released.

Table 6.3 SW_MODE register

6.4.3 coolStep Dialogue

This dialogue is designed for adjusting coolStep. The coolStep current is shown in red and the stallGuard2 load in blue. The coolStep current value increases/decreases adequate to the measured load on the axis. Energy savings can be optimized.

The input data area fields for the two motors are related to the COOLCONF register of the TMC5031.

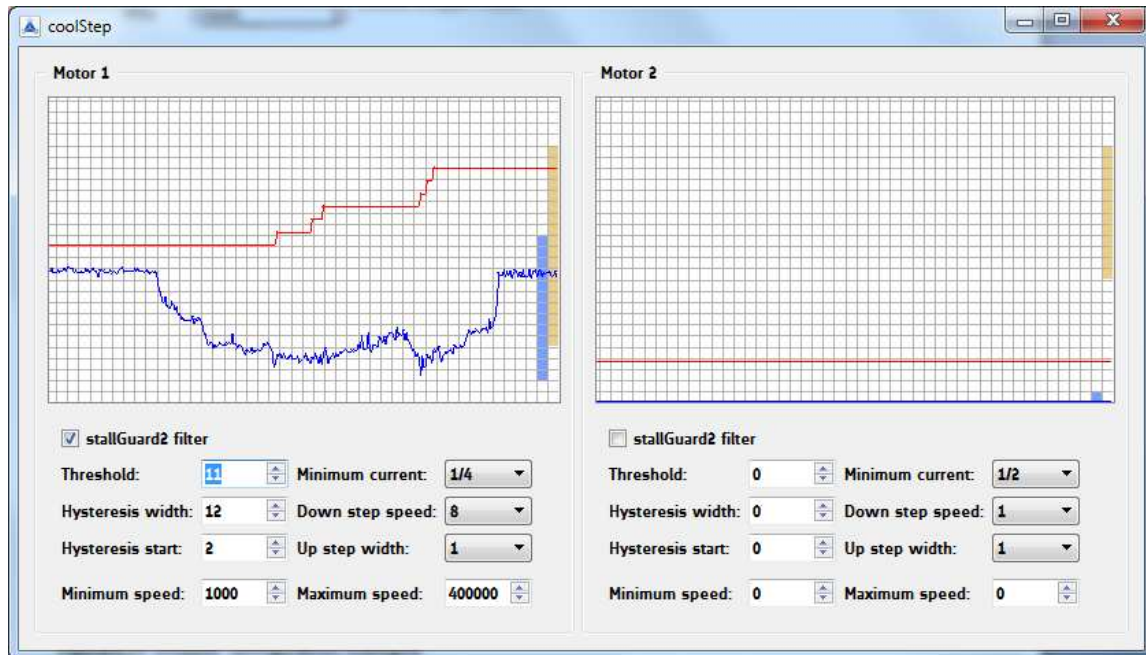

Figure 6.13 coolStep dialogue

0x6D, 0x7D: COOLCONF – SMART ENERGY CONTROL COOLSTEP AND STALLGUARD2				
Bit	Name	Function	Comment	
24	<i>sfilt</i>	stallGuard2 filter enable	0	Standard mode, high time resolution for stallGuard2
			1	Filtered mode, stallGuard2 signal updated for each four fullsteps only to compensate for motor pole tolerances
22	<i>sgt6</i>	stallGuard2 threshold value	This signed value controls stallGuard2 level for stall output and sets the optimum measurement range for readout. A lower value gives a higher sensitivity. Zero is the starting value working with most motors. -64 to +63: A higher value makes stallGuard2 less sensitive and requires more torque to indicate a stall.	
21	<i>sgt5</i>			
20	<i>sgt4</i>			
19	<i>sgt3</i>			
18	<i>sgt2</i>			
17	<i>sgt1</i>			
16	<i>sgt0</i>			
15	<i>seimin</i>	minimum current for smart current control	0: 1/2 of current setting (<i>IRUN</i>) 1: 1/4 of current setting (<i>IRUN</i>)	
14	<i>sedn1</i>	current down step speed	%00: For each 32 stallGuard2 values decrease by one %01: For each 8 stallGuard2 values decrease by one %10: For each 2 stallGuard2 values decrease by one %11: For each stallGuard2 value decrease by one	
13	<i>sedn0</i>			
11	<i>semax3</i>	stallGuard2 hysteresis value for smart current control	If the stallGuard2 result is equal to or above $(SEMIN+SEMAX+1)*32$, the motor current becomes decreased to save energy. %0000 ... %1111: 0 ... 15	
10	<i>semax2</i>			
9	<i>semax1</i>			
8	<i>semax0</i>			
6	<i>seup1</i>	current up step width	Current increment steps per measured stallGuard2 value %00 ... %11: 1, 2, 4, 8	
5	<i>seup0</i>			
3	<i>semin3</i>	minimum stallGuard2 value for smart current control and smart current enable	If the stallGuard2 result falls below $SEMIN*32$, the motor current becomes increased to reduce motor load angle. %0000: smart current control coolStep off %0001 ... %1111: 1 ... 15	
2	<i>semin2</i>			
1	<i>semin1</i>			
0	<i>semin0</i>			

Table 6.4 Abridgement of COOLCONF register

6.4.4 Chopper Configuration Dialogue

This dialogue has two tabs, one for motor 1 and the other one for motor 2. First, it is necessary to specify the chopper mode: *spreadCycle* or *Classic*.

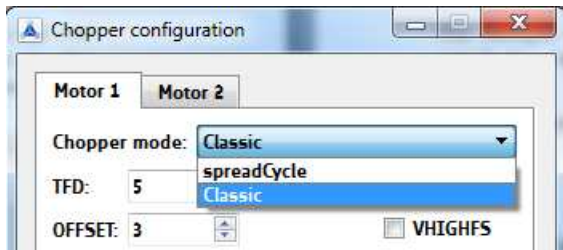

Figure 6.14 Choose chopper mode

spreadCycle (standard mode) and *classic* chopper (constant off time with fast decay time) have to be configured differently:

- For *spreadCycle* configuration the hysteresis has to be defined by setting a start value (HSTRT) and an end value (HEND).
- The *classic* chopper needs a fast decay time setting (TFD) and a specified offset (OFFSET).

Parameters with more than one bit have value fields; parameters with just one bit can be set by ticking them. Please refer to the chopper configuration register below for detailed information.

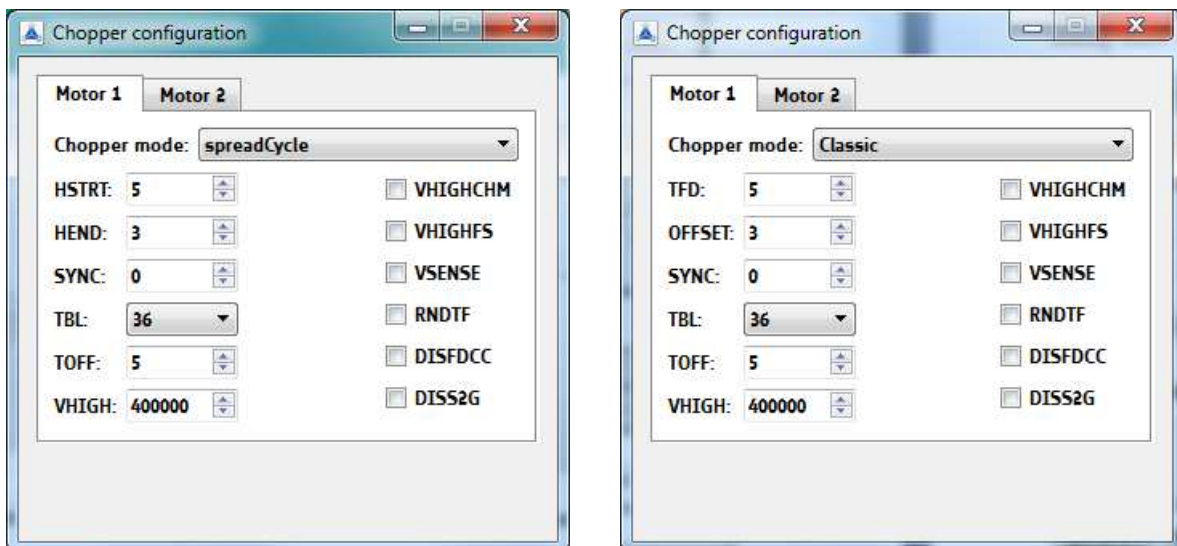

Figure 6.15 Chopper configuration dialogue (*spreadCycle* or *classic*)

0x6C, 0x7C: CHOPCONF – CHOPPER CONFIGURATION			
Bit	Name	Function	Comment
30	<i>diss2g</i>	short to GND protection disable	0: Short to GND protection is on 1: Short to GND protection is disabled
23	<i>sync3</i>	SYNC PWM synchronization clock	This register allows synchronization of the chopper for both phases of a two phase motor in order to avoid the occurrence of a beat, especially at low motor velocities. It is automatically switched off above VHIGH. %0000: Chopper sync function chopSync off %0001 ... %1111: Synchronization with $f_{\text{SYNC}} = f_{\text{CLK}} / (\text{sync} * 64)$ Hint: Set TOFF to a low value, so that the chopper cycle is ended, before the next sync clock pulse occurs. Set for the double desired chopper frequency for chm=0, for the desired base chopper frequency for chm=1.
22	<i>sync2</i>		
21	<i>sync1</i>		
20	<i>sync0</i>		

0x6C, 0x7C: CHOPCONF – CHOPPER CONFIGURATION				
Bit	Name	Function	Comment	
19	<i>vhighchm</i>	high velocity chopper mode	This bit enables switching to <i>chm</i> =1 and <i>fd</i> =0, when <i>VHIGH</i> is exceeded. This way, a higher velocity can be achieved. Can be combined with <i>vhighfs</i> =1. If set, the <i>TOFF</i> setting automatically becomes doubled during high velocity operation in order to avoid doubling of the chopper frequency.	
18	<i>vhighfs</i>	high velocity fullstep selection	This bit enables switching to fullstep, when <i>VHIGH</i> is exceeded. Switching takes place only at 45° position. The fullstep target current uses the current value from the microstep table at the 45° position.	
17	<i>vsense</i>	sense resistor voltage based current scaling	0: Low sensitivity, high sense resistor voltage 1: High sensitivity, low sense resistor voltage	
16	<i>tbl1</i>	TBL blank time select	%00 ... %11: Set comparator blank time to 16, 24, 36 or 54 clocks Hint: %10 is recommended for most applications	
15	<i>tbl0</i>			
14	<i>chm</i>	chopper mode	0	Standard mode (spreadCycle)
			1	Constant off time with fast decay time. Fast decay time is also terminated when the negative nominal current is reached. Fast decay is after on time.
13	<i>rndtf</i>	random <i>TOFF</i> time	0	Chopper off time is fixed as set by <i>TOFF</i>
			1	Random mode, <i>TOFF</i> is random modulated by $d_{NCLK} = -12 \dots +3$ clocks.
12	<i>disfdcc</i>	fast decay mode	<i>chm</i> =1: <i>disfdcc</i> =1 disables current comparator usage for termination of the fast decay cycle	
11	<i>fd3</i>	<i>TFD</i> [3]	<i>chm</i> =1: MSB of fast decay time setting <i>TFD</i>	
10	<i>hend3</i>	<i>HEND</i> hysteresis low value <i>OFFSET</i> sine wave offset	<i>chm</i> =0	%0000 ... %1111: Hysteresis is -3, -2, -1, 0, 1, ..., 12 (1/512 of this setting adds to current setting)
9	<i>hend2</i>			<i>chm</i> =1
8	<i>hend1</i>		%0000 ... %1111: Offset is -3, -2, -1, 0, 1, ..., 12 This is the sine wave offset and 1/512 of the value becomes added to the absolute value of each sine wave entry.	
7	<i>hend0</i>			
6	<i>hstrt2</i>	<i>HSTRT</i> hysteresis start value added to <i>HEND</i>	<i>chm</i> =0	%000 ... %111: Add 1, 2, ..., 8 to hysteresis low value <i>HEND</i> (1/512 of this setting adds to current setting) Attention: Effective $HEND + HSTRT \leq 16$. Hint: Hysteresis decrement is done each 16 clocks
5	<i>hstrt1</i>			
4	<i>hstrt0</i>			
		<i>TFD</i> [2..0] fast decay time setting	<i>chm</i> =1	Fast decay time setting (MSB: <i>fd3</i>): %0000 ... %1111: Fast decay time setting <i>TFD</i> with $NCLK = 32 * HSTRT$ (%0000: slow decay only)
3	<i>toff3</i>	<i>TOFF</i> off time and driver enable	Off time setting controls duration of slow decay phase $NCLK = 12 + 32 * TOFF$	
2	<i>toff2</i>		%0000: Driver disable, all bridges off	
1	<i>toff1</i>		%0001: 1 – use only with $TBL \geq 2$	
0	<i>toff0</i>		%0010 ... %1111: 2 ... 15	

Table 6.5 Abridgement of CHOPCONF register

6.4.5 Driver Status Information

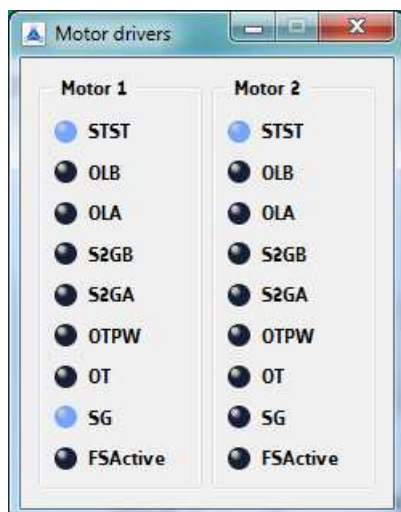

This dialogue shows all driver error flags of the two motor drivers. The flags are related to the DRV_STATUS register. Blue marked flags are set.

Figure 6.16 Motor driver error flags

0x6F, 0x7F: DRV_STATUS – STALLGUARD2 VALUE AND DRIVER ERROR FLAGS			
Bit	Name	Function	Comment
31	<i>stst</i>	standstill indicator	This flag indicates motor stand still.
30	<i>olb</i>	open load indicator phase B	1: Open load detected on phase A or B <i>Hint:</i> This is just an informative flag. The driver takes no action upon it. False detection may occur in fast motion and standstill. Check during slow motion, only.
29	<i>ola</i>	open load indicator phase A	
28	<i>s2gb</i>	short to ground indicator phase B	1: Short to GND detected on phase A or B The driver becomes disabled. The flags stay active, until the driver is disabled by software or by the ENN input.
27	<i>s2ga</i>	short to ground indicator phase A	
26	<i>otpw</i>	overtemperature pre-warning flag	1: Overtemperature pre-warning threshold is exceeded. The overtemperature pre-warning flag is common for both drivers.
25	<i>ot</i>	overtemperature flag	1: Overtemperature limit has been reached. Drivers become disabled until <i>otpw</i> is also cleared due to cooling down of the IC. The overtemperature flag is common for both drivers.
15	<i>fsactive</i>	full step active indicator	1: Indicates that the driver has switched to fullstep as defined by chopper mode settings and velocity thresholds.

Table 6.6 Abridgement of DRV_STATUS register

6.4.6 Microstep Wave Dialogue

The microstep wave dialogue has two tabs, one for motor 1 and the other one for motor 2. Each motor driver of the TMC5031 provides a programmable look-up table for storing the microstep current wave. Per default, the tables are pre-programmed with a sine wave, which is a good starting point for most stepper motors. Reprogramming the table to a motor specific wave allows improved microstepping. In order to minimize required memory and the amount of data to be programmed, only a quarter of the wave becomes stored. The internal microstep table maps the microstep wave from 0° to 90°. It becomes symmetrically extended to 360°.

The microstep wave dialogue for each motor has four input fields (a1, a3, a5, and a7) for amplitude settings. These values are used for the microstep wave calculation. All amplitude values normally should meet the condition $a1 \gg a3 \gg a5 \gg a7$ within the range 0.00... 1.00. The microstep wave calculation is done via Fourier synthesis.

Please refer to the MOTOR DRIVER REGISTER of the TMC5031 datasheet.

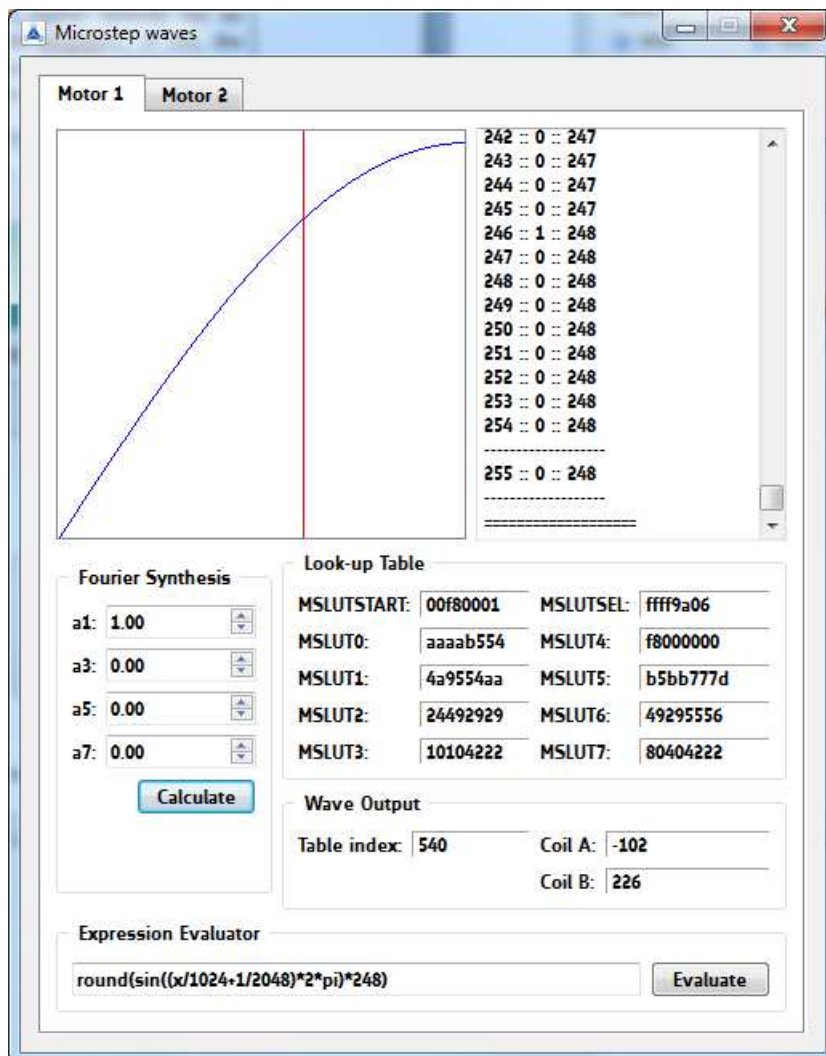

Figure 6.17 Microstep wave dialogue with sin wave (default setting)

The formula in the *expression evaluator* can be changed to optimize motor performance. Have a look at the following examples, please.

EXAMPLE 1: TRIANGULAR MICROSTEP CURVE

For a triangular curve, enter the following formula into the *expression evaluator*:

$$\text{round} \frac{x}{256} \times 248$$

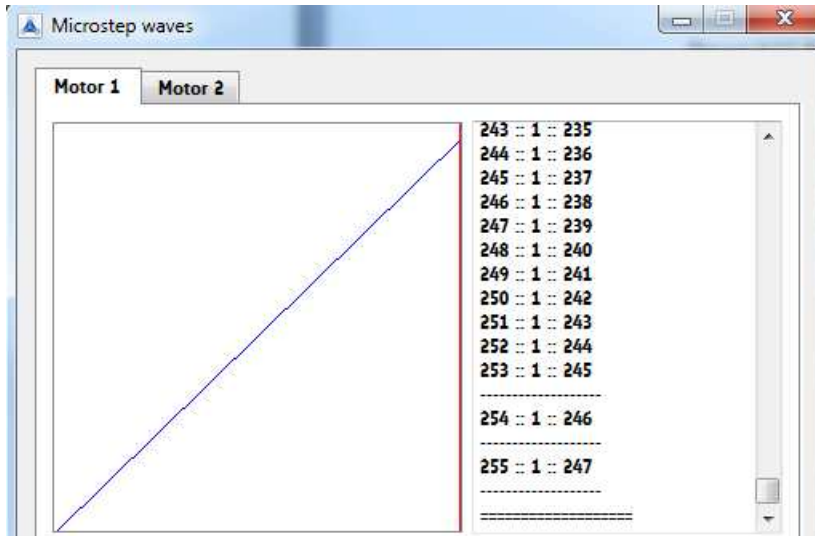

Figure 6.18 Triangular curve

EXAMPLE 2: MICROSTEP WAVE WITH LINEAR SCALED SINE WAVE AMPLITUDE

For a wave with linear scaled sine wave amplitude the following formula may fit:

$$\text{round} \left(\sin \left(\left(\frac{x}{1024} + \frac{1}{2048} \right) \times 2 \times \pi \right) \times \left(240 + \left(\frac{256-x}{256} \right) \times 80 \right) \right)$$

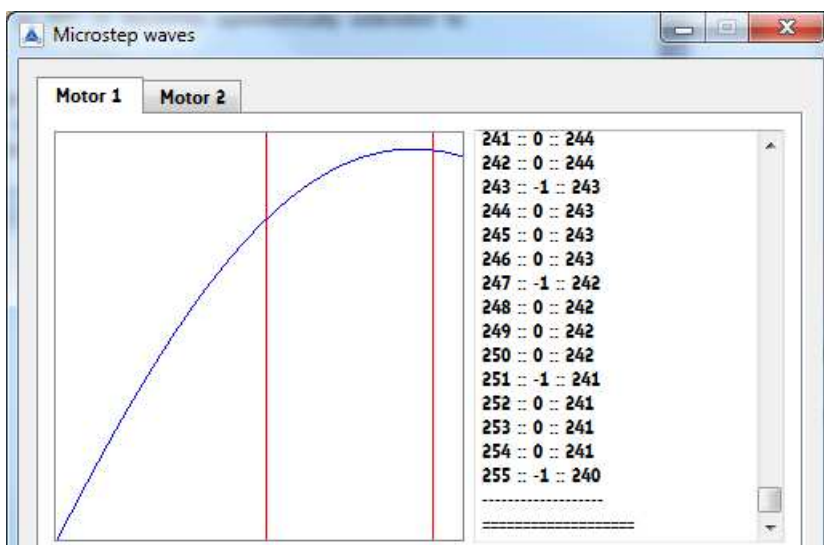

Figure 6.19 Example for microstep wave with linear scaled sine wave amplitude

MOTOR DRIVER REGISTER SET (MOTOR 1: 0x60...0x6F, MOTOR 2: 0x70...0x7F)					
R/W	Addr	n	Register	Description / bit names	Range [Unit]
W	0x60 0x70	32	<i>MSLUT1[0]</i> <i>MSLUT2[0]</i> microstep table entries 0...31	Each bit gives the difference between microstep x and x+1 when combined with the corresponding <i>MSLUTSEL W</i> bits: 0: <i>W</i> = %00: -1 %01: +0 %10: +1 %11: +2 1: <i>W</i> = %00: +0 %01: +1 %10: +2 %11: +3	32x 0 or 1 <i>reset default=</i> <i>sine wave</i> <i>table</i>
W	0x61 ... 0x67 0x71 ... 0x77	7 x 32	<i>MSLUT1[1...7]</i> <i>MSLUT2[1...7]</i> microstep table entries 32...255	This is the differential coding for the first quarter of a wave. Start values for <i>CUR_A</i> and <i>CUR_B</i> are stored for <i>MSCNT</i> position 0 in <i>START_SIN</i> and <i>START_SIN90_120</i> . <i>ofs31, ofs30, ..., ofs01, ofs00</i> ... <i>ofs255, ofs254, ..., ofs225, ofs224</i>	7x 32x 0 or 1 <i>reset default=</i> <i>sine wave</i> <i>table</i>
W	0x68 0x78	32	<i>MSLUTSEL1</i> <i>MSLUTSEL2</i>	This register defines four segments within each quarter <i>MSLUT</i> wave. Four 2 bit entries determine the meaning of a 0 and a 1 bit in the corresponding segment of <i>MSLUT</i> . <i>See separate table in TMC5031 datasheet.</i>	0< <i>X1</i> < <i>X2</i> < <i>X3</i> <i>reset default=</i> <i>sine wave</i> <i>table</i>
W	0x69 0x79	8 + 8	<i>MSLUTSTART</i>	bit 7... 0: <i>START_SIN</i> bit 23... 16: <i>START_SIN90_120</i> <i>START_SIN</i> gives the absolute current at microstep table entry 0. <i>START_SIN90_120</i> gives the absolute current for microstep table entry at positions 256. Start values are transferred to the microstep registers <i>CUR_A</i> and <i>CUR_B</i> , whenever the reference position <i>MSCNT=0</i> is passed.	<i>START_SIN</i> <i>reset default</i> <i>=0</i> <i>START_SIN90_1</i> <i>20</i> <i>reset default</i> <i>=247</i>

Table 6.7 Abridgement of motor driver register set

Please refer to the TMC5031 datasheet for detailed information about microstep table registers.

6.4.7 Global Configuration Dialogue

This dialogue shows global status flags on the front tab and global settings on the rear tab. These flags and settings are related to the GENERAL CONFIGURATION REGISTERS of the TMC5031. Flags can be pulled continuously or on demand. Blue marked flags are set.

Note that the direction of motor 2 is reversed per default. This way, both motors rotate in the same direction. In hardware, motor 2 is connected mirror-inverted.

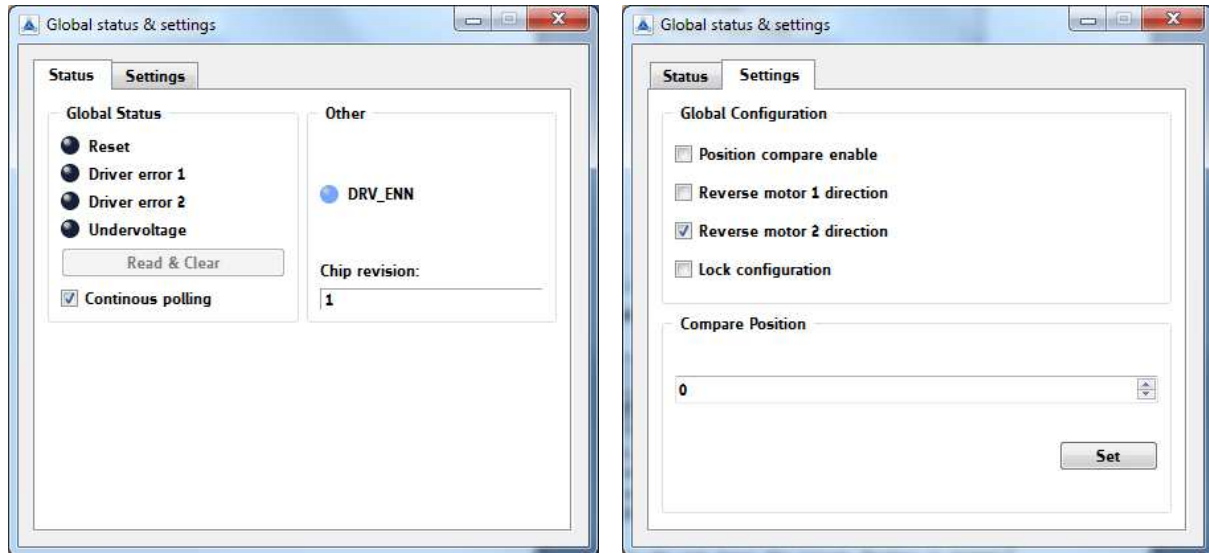

Figure 6.20 Global status tab and global settings tab

GENERAL CONFIGURATION REGISTERS (0x00...0x1F)					
R/W	Addr	n	Register	Description / bit names	
RW	0x00	11	GCONF	Bit	GCONF – Global configuration flags
				3	<i>poscmp_enable</i> 0: Outputs INT and PP are tristated. 1: Position compare pulse (PP) and interrupt output (INT) are available <i>Attention: do not leave the outputs floating in tristate condition, provide an external pull-up or set this bit 1.</i>
				8	<i>shaft1</i> 1: Inverse motor 1 direction
				9	<i>shaft2</i> 1: Inverse motor 2 direction
				10	<i>lock_gconf</i> 1: GCONF is locked against further write access.
R+C	0x01	4	GSTAT	Bit	GSTAT – Global status flags
				0	<i>reset</i> 1: Indicates that the IC has been reset since the last read access to GSTAT.
				1	<i>drv_err1</i> 1: Indicates, that driver 1 has been shut down due to an error since the last read access.
				2	<i>drv_err2</i> 1: Indicates, that driver 2 has been shut down due to an error since the last read access.
				3	<i>uv_cp</i> 1: Indicates an undervoltage on the charge pump. The driver is disabled in this case.

GENERAL CONFIGURATION REGISTERS (0x00...0x1F)				
R/W	Addr	n	Register	Description / bit names
W	0x05	32	X_COMPARE	Position comparison register for motor 1 position strobe. Activate <i>poscmp_enable</i> to get position pulse on output PP. <i>XACTUAL</i> = X_COMPARE: - Output PP becomes high. It returns to a low state, if the positions mismatch.

Table 6.8 Abridgement of general configuration registers

6.4.8 All Registers Dialogue

This dialogue shows all registers, which can be set and/or read out with the TMC50xx-EVAL software tool. Addresses, register names and actual values can be read. New values can be written in the specific data input fields. To copy an actual value into a new value field just double-click the actual value. New values can be changed on the fly while the motor is still rotating.

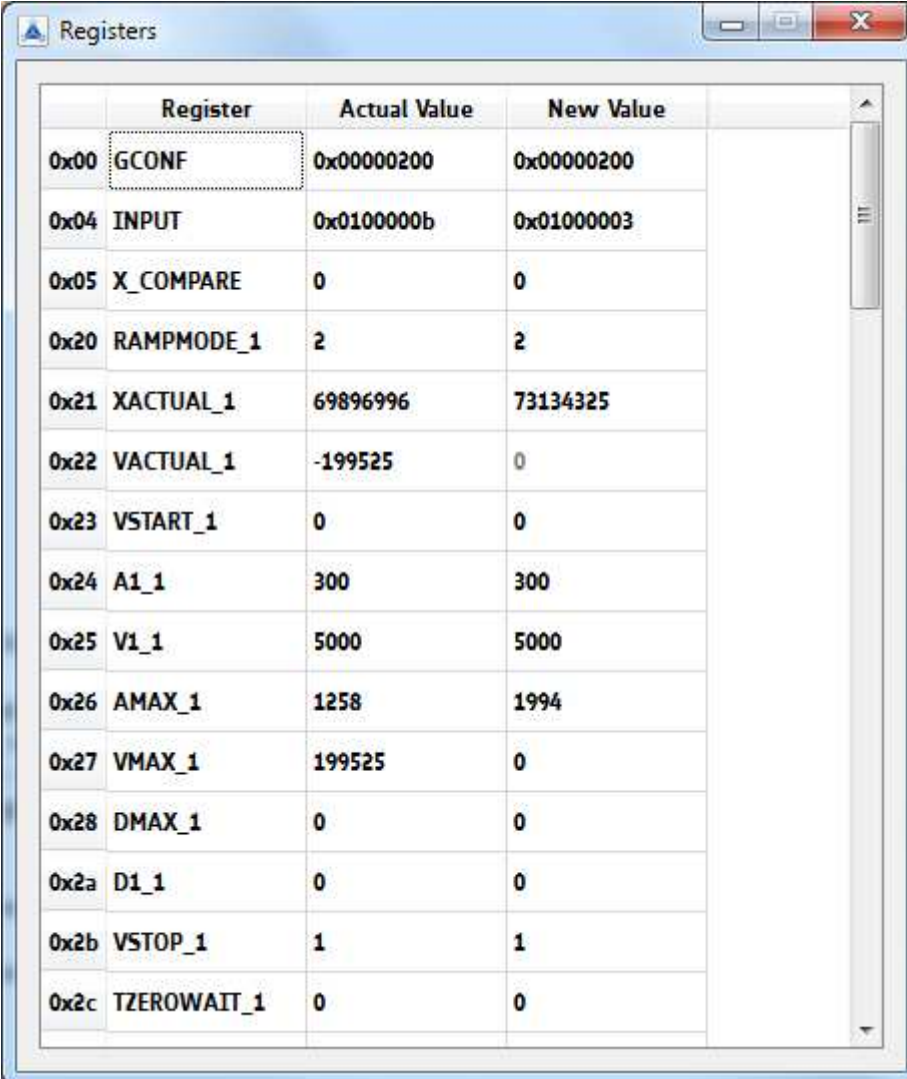

Register	Actual Value	New Value
0x00 GCONF	0x00000200	0x00000200
0x04 INPUT	0x0100000b	0x01000003
0x05 X_COMPARE	0	0
0x20 RAMPMODE_1	2	2
0x21 XACTUAL_1	69896996	73134325
0x22 VACTUAL_1	-199525	0
0x23 VSTART_1	0	0
0x24 A1_1	300	300
0x25 V1_1	5000	5000
0x26 AMAX_1	1258	1994
0x27 VMAX_1	199525	0
0x28 DMAX_1	0	0
0x2a D1_1	0	0
0x2b VSTOP_1	1	1
0x2c TZEROWAIT_1	0	0

Figure 6.21 All registers dialogue

7 Life Support Policy

TRINAMIC Motion Control GmbH & Co. KG does not authorize or warrant any of its products for use in life support systems, without the specific written consent of TRINAMIC Motion Control GmbH & Co. KG.

Life support systems are equipment intended to support or sustain life, and whose failure to perform, when properly used in accordance with instructions provided, can be reasonably expected to result in personal injury or death.

© TRINAMIC Motion Control GmbH & Co. KG 2013

Information given in this data sheet is believed to be accurate and reliable. However neither responsibility is assumed for the consequences of its use nor for any infringement of patents or other rights of third parties, which may result from its use.

Specifications are subject to change without notice.

All trademarks used are property of their respective owners.



8 Revision History

8.1 Firmware Revision

Version	Date	Author	Description
1.0	2013-JAN-23	OK, MJ	Initial version

Table 8.1: Firmware revision

8.2 Document Revision

Version	Date	Author <small>SD – Sonja Dwersteg</small>	Description
1.00	2013-FEB-22	SD	Initial version
1.01	2013-MAR-26	SD	<ul style="list-style-type: none">- Information about the installation of a virtual com port for USB interface updated (chapter 5 and chapter 5.1).- Photo of the module new.

Table 8.2 Document revision

9 References

[TMC5031] TMC5031 Datasheet (please refer to <http://www.trinamic.com>)