

# HIL CONNECTOR

## 3.3mm pitch/Crimp style Wire-to-wire connectors

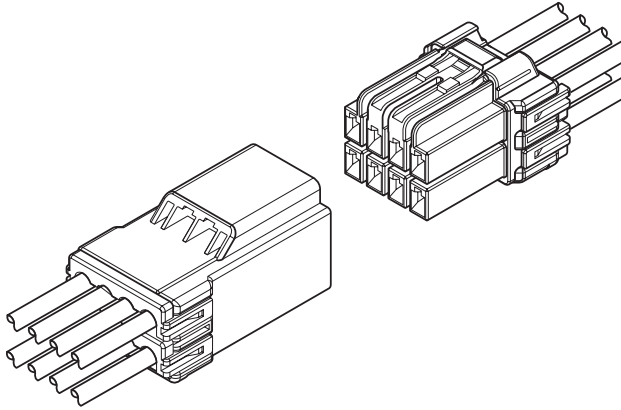

**This HIL connector is 3.3mm pitch wire-to-wire connector that has a mechanism to prevent an incomplete mating when mating connector.**

- **Inertia lock mechanism to prevent an incomplete mating**
- **Box-shaped contact to prevent the influence by external forces**
- **Polarizing key to prevent connector from mating with incorrect circuits**

### Assembly layout

<2, 3 circuits>

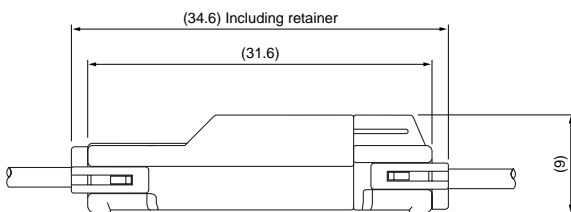

<4, 6, 8 circuits>

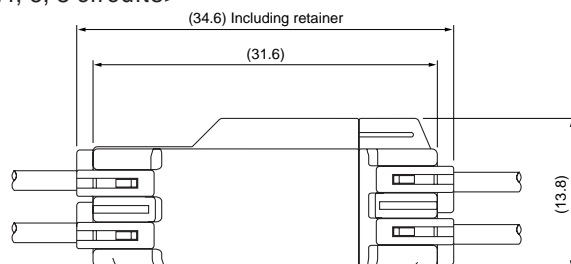

### Specifications

- Current rating: 5A AC, DC (2 circuits AWG #18)
  - Voltage rating: 300V AC, DC
  - Temperature range: -25°C to +85°C  
(including temperature rise in applying electrical current)
  - Contact resistance: Initial value/10m max.  
After environmental testing/20m max.
  - Insulation resistance: 1,000M min.
  - Withstanding voltage: 1,500V AC/minute
  - Applicable wire: Conductor size/01 type AWG #24 to #20  
/21 type AWG #22 to #18  
Insulation O.D./01 type 1.3 to 2.5mm  
/21 type 1.5 to 2.7mm  
(when using retainer for 21 type 1.5 to 2.5mm)
- \* Compliant with RoHS.  
\* Refer to "General Instruction and Notice when using Terminals and Connectors" at the end of this catalog.  
\* Contact JST for details.

Note: The current rating varies depending on the number of circuits and the wire size used in each connector. The table below lists the current rating as a function of the number of circuits and the wire size.

Current unit: A

Circuits	Wire size (AWG)			
	#18	#20	#22	#24
2	5	4	3	3
3	4	4	3	2
4	3	3	2	2
6	3	3	2	2
8	3	3	2	2

### List of combinations

Resin color (Plug/ Receptacle)	Natural	Red	Blue
Polarizing key pattern	Polarizing key pattern 1	Polarizing key pattern 2	Polarizing key pattern 3
Plug Model No.	HILP-( )V-1-S	HILP-( )V-2-R	HILP-( )V-3-E
Receptacle Model No.	HILR-( )VF-1-S	HILR-( )VF-2-R	HILR-( )VF-3-E

# HIL CONNECTOR

## Contact

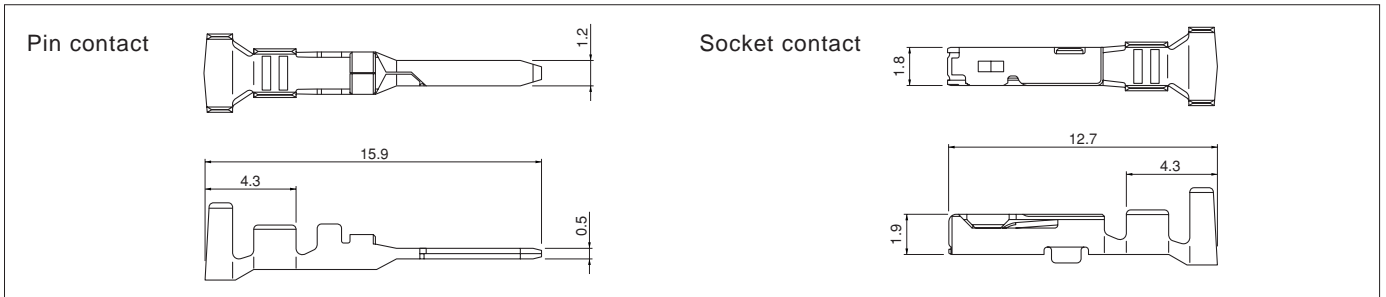

Model No.		Applicable wire		Insulation O.D. (mm)	Q'ty / reel
Pin contact	Socket contact	mm <sup>2</sup>	AWG #		
<b>SHIM-01T-P0.5</b>	<b>SHIF-01T-P0.5</b>	0.2~0.5	24~20	1.3~2.5	5,000
<b>SHIM-21T-P0.5</b>	<b>SHIF-21T-P0.5</b>	0.3~0.75	22~18	1.5~2.7	5,000

### Material and Finish

Copper alloy, tin-plated

### RoHS compliance

Note: Insulation O.D. is 1.5mm to 2.5mm when using retainer for 21 type barrel size contact.

Contact	Crimping machine	Applicator			Contact	Crimping machine	Applicator		
		Crimp applicator	Dies	Crimp applicator with dies			Crimp applicator	Dies	Crimp applicator with dies
<b>SHIM-01T-P0.5</b>	AP-K2N	MKS-L	MK/SHIF/M-01-05	APLMK SHIF/M01-05	<b>SHIF-01T-P0.5</b>	AP-K2N	MKS-L	MK/SHIF/M-01-05	APLMK SHIF/M01-05
<b>SHIM-21T-P0.5</b>			MK/SHIF/M-21-05	APLMK SHIF/M21-05	<b>SHIF-21T-P0.5</b>			MK/SHIF/M-21-05	APLMK SHIF/M21-05

## Contact position location numbers

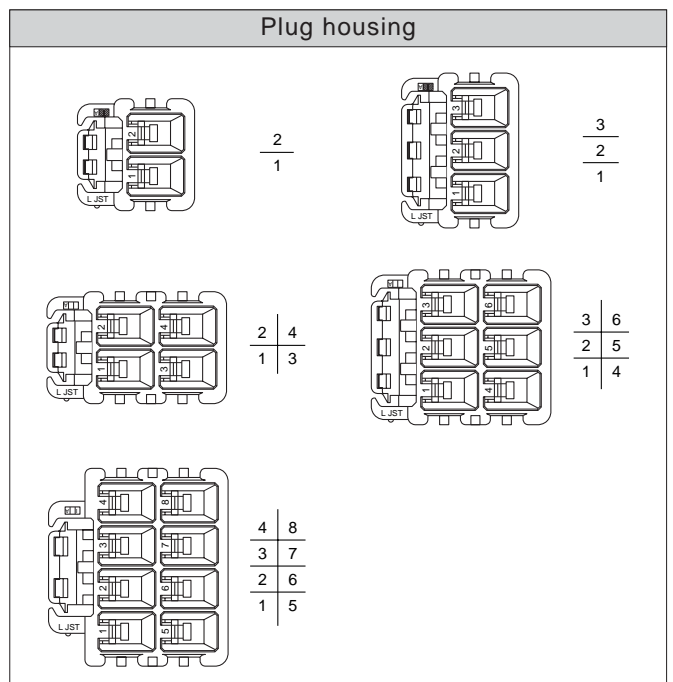
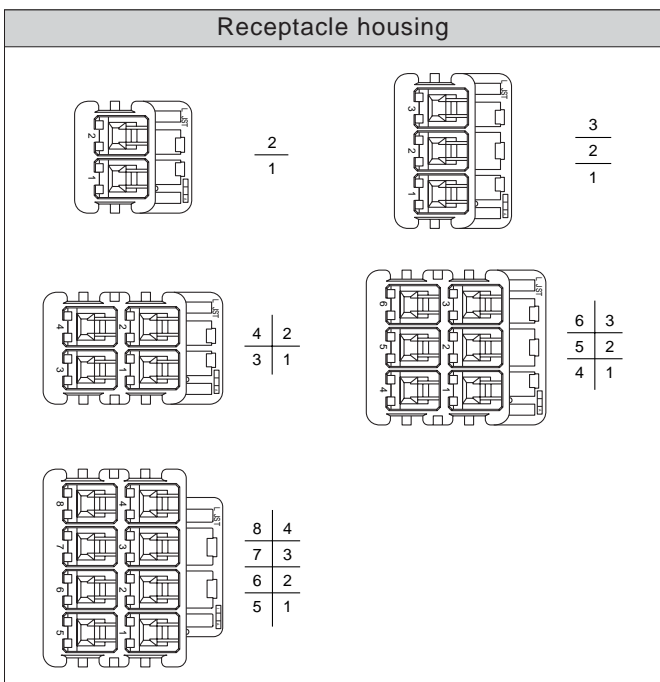
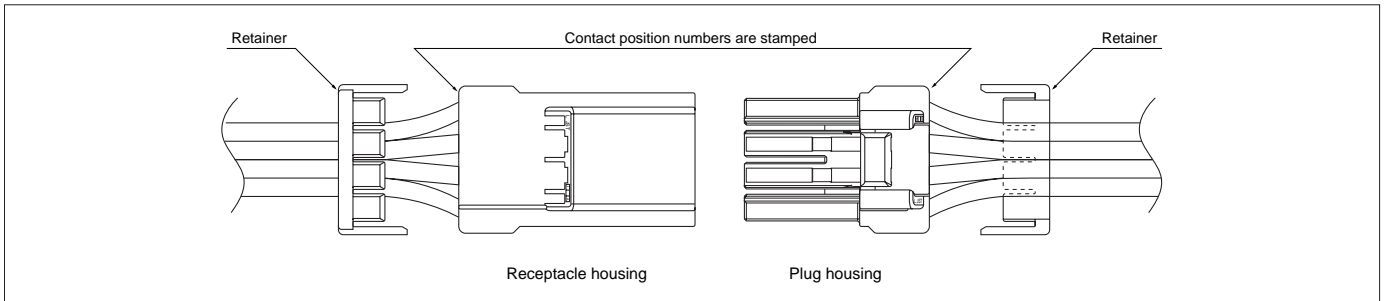

# HIL CONNECTOR

## Housing

Material: Housing...PA 66, UL94V-0, natural  
Retainer...Glass-filled PA 66, UL94V-0, natural

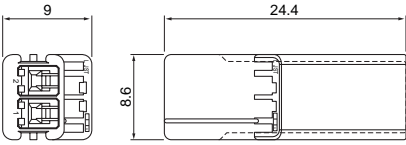
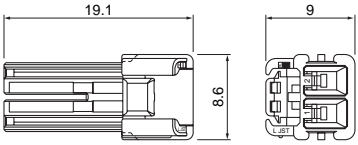
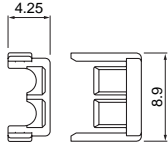
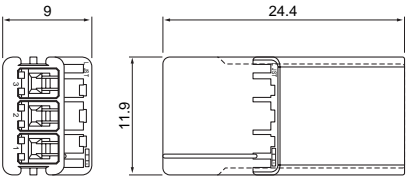
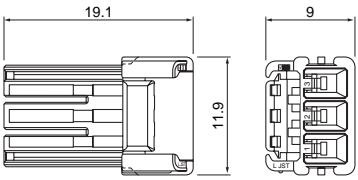
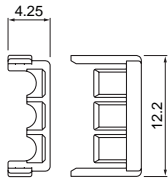
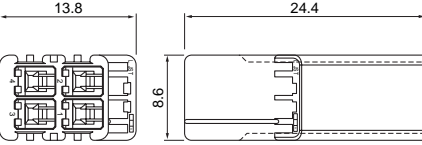
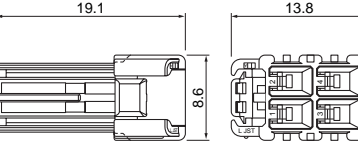
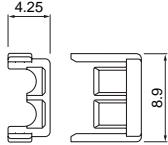
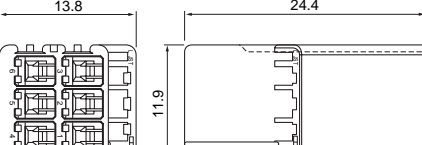
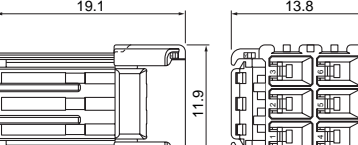
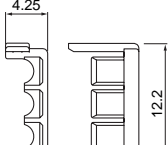
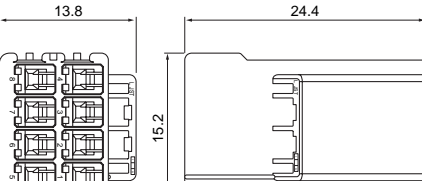
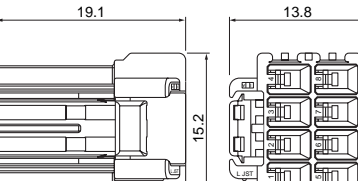
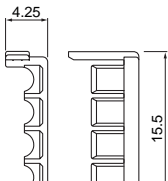
Circuits	Voltage rating	Current rating	Receptacle housing (for pin contact)		Plug housing (for socket contact)		Retainer	
2	300V	5A	<b>HILR-02VF-1-S</b> 	Q'ty / bag 1,000	<b>HILP-02V-1-S</b> 	Q'ty / bag 1,000	<b>HILS-02V</b> (commonly used for 2-circuit housing and 4-circuit housing) 	Q'ty / bag 1,000
3	300V	4A	<b>HILR-03VF-1-S</b> 	Q'ty / bag 1,000	<b>HILP-03V-1-S</b> 	Q'ty / bag 1,000	<b>HILS-03V</b> (commonly used for 3-circuit housing and 6-circuit housing) 	Q'ty / bag 1,000
4	300V	3A	<b>HILR-04VF-1-S</b> 	Q'ty / bag 1,000	<b>HILP-04V-1-S</b> 	Q'ty / bag 1,000	<b>HILS-02V</b> (commonly used for 2-circuit housing and 4-circuit housing) 	Q'ty / bag 1,000
6	300V	3A	<b>HILR-06VF-1-S</b> 	Q'ty / bag 500	<b>HILP-06V-1-S</b> 	Q'ty / bag 1,000	<b>HILS-03V</b> (commonly used for 3-circuit housing and 6-circuit housing) 	Q'ty / bag 1,000
8	300V	3A	<b>HILR-08VF-1-S</b> 	Q'ty / bag 500	<b>HILP-08V-1-S</b> 	Q'ty / bag 1,000	<b>HILS-04V</b> 	Q'ty / bag 1,000

RoHS compliance

Note: Current rating is for use with AWG #18 wire.