

MULTI-LAYER HIGH-Q CAPACITORS

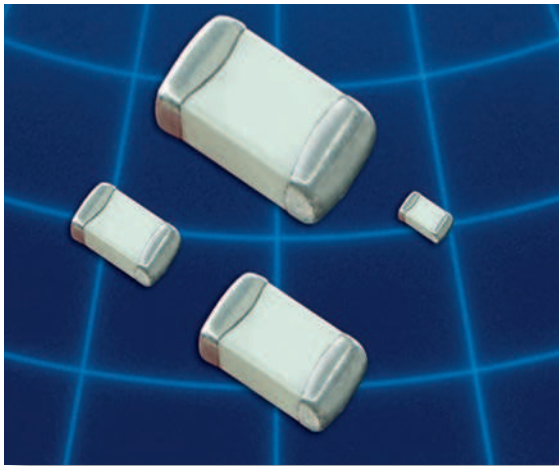

These lines of multilayer capacitors have been developed for High-Q and microwave applications.

- The **S-Series** (R03S, R07S, R14S, R15S) capacitors give an ultra-high Q performance, and exhibit NP0 temperature characteristics.
- The **L-Series** (R05L) capacitors give mid-high Q performance, and exhibit NP0 temperature characteristics.
- The **E-Series** (S42E, S48E, S58E) capacitors give excellent high-Q performance from HF to Microwave frequencies. Typical uses are high voltage, high current applications. They are offered in chip (Ni barrier or Non-Magnetic Pt.-Ag) or in Non-Magnetic leaded form.
- The **W-Series** (R05W) capacitors offer a large capacitance value in an ultra-small 0201 package size. These exhibit a X7R temperature characteristic.
- RoHS compliance is standard for all unleaded parts (see termination options box).

HOW TO ORDER

| | | | | | | | |
|---|---|---|--|---|---|---|----------|
| 252 | S48 | E | 470 | K | V | 4 | E |
| VOLTAGE (DC) 6R3 = 6.3 V 101 = 100 V 160 = 16 V 250 = 25 V 500 = 50 V 201 = 200 V 251 = 250 V 301 = 300 V 501 = 500 V 102 = 1000 V 152 = 1500 V 202 = 2000 V 252 = 2500 V 362 = 3600 V 502 = 5000 V 722 = 7200 V | CASE SIZE R03 (01005) R05 (0201) R07 (0402) R14 (0603) R15 (0805) S42 (1111) S48 (2525) S58 (3838) | CAPACITANCE (pF) 1st two digits are significant; third digit denotes number of zeros, R = decimal. 100 = 10 pF 101 = 100 pF | DIELECTRIC S = Ultra High Q NPO L = High Q NPO E = Ultra High Q NPO, High Voltage, High Power, *T = High Temp (175C) Ultra High Q NPO W = X7R | TOLERANCE A = ± 0.05 pF B = ± 0.10 pF C = ± 0.25 pF D = ± 0.50 pF F = ± 1 % G = ± 2 % J = ± 5 % K = ± 10 % For tolerance availability, see chart. | TERMINATION Nickel Barrier V = Ni/Sn (Green) T = Ni/SnPb G = Ni/Au (Green) Non-Mag* U = Cu/Sn (Green) C = Cu/SnPb Leaded (All Non-Mag)* 1 = Microstrip 2 = Axial Ribbon 3 = Axial Wire 4 = Radial Ribbon 5 = Radial Wire | PACKAGING S = Bulk W = Waffle Pack 01005 - 0603 Y = Paper 5" Reel T = Paper 7" Reel *R = Paper 13" Reel *J = Paper 5" Reel - Horizontally Oriented Electrodes *N = Paper 5" Reel - Vertically Oriented Electrodes *L = Paper 7" Reel - Horizontally Oriented Electrodes *V = Paper 7" Reel - Vertically Oriented Electrodes 0805 - 3838 Z = Embossed 5" Reel E = Embossed 7" Reel *U = Embossed 13" Reel *M = Embossed 5" Reel - Horizontally Oriented Electrodes *Q = Embossed 5" Reel - Vertically Oriented Electrodes *G = Embossed 7" Reel - Horizontally Oriented Electrodes *P = Embossed 7" Reel - Vertically Oriented Electrodes Tape specifications conform to EIA RS481 | |
| Part Number written: 252S48E470KV4E | | | | | | MARKING 3 = Cap Code & Tolerance 4 = No Marking 6 = EIA Code (Marking on 0805 and larger only) | |



** - Not available for all MLCC - Call factory for info.

LOW ESR / HIGH-Q CAPACITOR SELECTION CHART

| EIA Size | | Miniature Size - Portable Electronics | | | | RF Power Applications | | | | | | | | |
|---------------|-------------------|---------------------------------------|------------|-----|----------------|-----------------------|----------------|----------------|----------------|----------------|----------------|-------|-------|-------|
| | | 01005 (R03S) | 0201 (R05) | | 0402 (R07S) | 0603 (R14S) | 0805 (R15S) | 0805 (R15E) | 1111 (S42E) | 2525 (S48E) | 3838 (S58E) | | | |
| NPO (R05L) | X7R* (R05W) | | | | | | | | | | | | | |
| Cap. Value | Capacitance pF | Code | Voltage | | | | | | | | | | | |
| | | | 0.1 | 0R1 | A | | | | | | | | | |
| 0.2 | 0R2 | 16 V | 25 V | | | 50/200 V | 250 V | | | 500V | 1000V | | | |
| 0.3 | 0R3 | 16 V | 25 V | | | 50/200 V | 250 V | 250 V | 500V | 500V | 1000V | | | |
| 0.4 | 0R4 | 16 V | 25 V | | | 50/200 V | 250 V | 250 V | 500V | 500V | 1000V | | | |
| 0.5 | 0R5 | 16 V | 25 V | | | 50/200 V | 250 V | 250 V | 500V | 500V | 1000V | 2500V | | |
| 0.6 | 0R6 | 16 V | 25 V | | | 50/200 V | 250 V | 250 V | 500V | 500V | 1000V | 2500V | 3600V | 7200V |
| 0.7 | 0R7 | 16 V | 25 V | | | 50/200 V | 250 V | 250 V | 500V | 500V | 1000V | 2500V | 3600V | 7200V |
| 0.8 | 0R8 | 16 V | 25 V | | | 50/200 V | 250 V | 250 V | 500V | 500V | 1000V | 2500V | 3600V | 7200V |
| 0.9 | 0R9 | 16 V | 25 V | | | 50/200 V | 250 V | 250 V | 500V | 500V | 1000V | 2500V | 3600V | 7200V |
| 1.0 | 1R0 | 16 V | 25 V | | | 50/200 V | 250 V | 250 V | 500V | 500V | 1000V | 2500V | 3600V | 7200V |
| 1.1 | 1R1 | 16 V | 25 V | | | 50/200 V | 250 V | 250 V | 500V | 500V | 1000V | 2500V | 3600V | 7200V |
| 1.2 | 1R2 | 16 V | 25 V | | | 50/200 V | 250 V | 250 V | 500V | 500V | 1000V | 2500V | 3600V | 7200V |
| 1.3 | 1R3 | 16 V | 25 V | | | 50/200 V | 250 V | 250 V | 500V | 500V | 1000V | 2500V | 3600V | 7200V |
| 1.4 | 1R4 | 16 V | 25 V | | | 50/200 V | 250 V | 250 V | 500V | 500V | 1000V | 2500V | 3600V | 7200V |
| 1.5 | 1R5 | 16 V | 25 V | | | 50/200 V | 250 V | 250 V | 500V | 500V | 1000V | 2500V | 3600V | 7200V |
| 1.6 | 1R6 | 16 V | 25 V | | | 50/200 V | 250 V | 250 V | 500V | 500V | 1000V | 2500V | 3600V | 7200V |
| 1.7 | 1R7 | 16 V | 25 V | | | 50/200 V | 250 V | 250 V | 500V | 500V | 1000V | 2500V | 3600V | 7200V |
| 1.8 | 1R8 | 16 V | 25 V | | | 50/200 V | 250 V | 250 V | 500V | 500V | 1000V | 2500V | 3600V | 7200V |
| 1.9 | 1R9 | 16 V | 25 V | | | 50/200 V | 250 V | 250 V | 500V | 500V | 1000V | 2500V | 3600V | 7200V |
| 2.0 | 2R0 | 16 V | 25 V | | | 50/200 V | 250 V | 250 V | 500V | 500V | 1000V | 2500V | 3600V | 7200V |
| 2.1 | 2R1 | 16 V | 25 V | | | 50/200 V | 250 V | 250 V | 500V | 500V | 1000V | 2500V | 3600V | 7200V |
| 2.2 | 2R2 | 16 V | 25 V | | | 50/200 V | 250 V | 250 V | 500V | 500V | 1000V | 2500V | 3600V | 7200V |
| 2.4 | 2R4 | 16 V | 25 V | | | 50/200 V | 250 V | 250 V | 500V | 500V | 1000V | 2500V | 3600V | 7200V |
| 2.7 | 2R7 | 16 V | 25 V | | | 50 V | 250 V | 250 V | 500V | 500V | 1000V | 2500V | 3600V | 7200V |
| 3.0 | 3R0 | 16 V | 25 V | | | 50 V | 250 V | 250 V | 500V | 500V | 1000V | 2500V | 3600V | 7200V |
| 3.3 | 3R3 | 16 V | 25 V | | | 50 V | 250 V | 250 V | 500V | 500V | 1000V | 2500V | 3600V | 7200V |
| 3.6 | 3R6 | 16 V | 25 V | | | 50 V | 250 V | 250 V | 500V | 500V | 1000V | 2500V | 3600V | 7200V |
| 3.9 | 3R9 | 16 V | 25 V | | | 50 V | 250 V | 250 V | 500V | 500V | 1000V | 2500V | 3600V | 7200V |
| 4.3 | 4R3 | 16 V | 25 V | | | 50 V | 250 V | 250 V | 500V | 500V | 1000V | 2500V | 3600V | 7200V |
| 4.7 | 4R7 | 16 V | 25 V | | | 50 V | 250 V | 250 V | 500V | 500V | 1000V | 2500V | 3600V | 7200V |
| 5.1 | 5R1 | 16 V | 25 V | | | 50 V | 250 V | 250 V | 500V | 500V | 1000V | 2500V | 3600V | 7200V |
| 5.6 | 5R6 | 16 V | 25 V | | | 50 V | 250 V | 250 V | 500V | 500V | 1000V | 2500V | 3600V | 7200V |
| 6.2 | 6R2 | 16 V | 25 V | | | 50 V | 250 V | 250 V | 500V | 500V | 1000V | 2500V | 3600V | 7200V |
| 6.8 | 6R8 | 16 V | 25 V | | 50 V | 250 V | 250 V | 500V | 500V | 1000V | 2500V | 3600V | 7200V | |
| 7.5 | 7R5 | 16 V | 25 V | | 50 V | 250 V | 250 V | 500V | 500V | 1000V | 2500V | 3600V | 7200V | |
| 8.2 | 8R2 | 16 V | 25 V | | 50 V | 250 V | 250 V | 500V | 500V | 1000V | 2500V | 3600V | 7200V | |
| 9.1 | 9R1 | 16 V | 25 V | | 50 V | 250 V | 250 V | 500V | 500V | 1000V | 2500V | 3600V | 7200V | |
| 10 | 100 | 16 V | 25 V | | 50 V | 250 V | 250 V | 500V | 500V | 1000V | 2500V | 3600V | 7200V | |
| 11 | 110 | 16 V | 25 V | | 50 V | 250 V | 250 V | 500V | 500V | 1000V | 2500V | 3600V | 7200V | |
| 12 | 120 | 16 V | 25 V | | 50 V | 250 V | 250 V | 500V | 500V | 1000V | 2500V | 3600V | 7200V | |
| 13 | 130 | 16 V | 25 V | | 50 V | 250 V | 250 V | 500V | 500V | 1000V | 2500V | 3600V | 7200V | |
| 15 | 150 | 16 V | 25 V | | 50 V | 250 V | 250 V | 500V | 500V | 1000V | 2500V | 3600V | 7200V | |
| 16 | 160 | 16 V | 25 V | | 50 V | 250 V | 250 V | 500V | 500V | 1000V | 2500V | 3600V | 7200V | |
| 18 | 180 | | 25 V | | 50 V | 250 V | 250 V | 500V | 500V | 1000V | 2500V | 3600V | 7200V | |
| 20 | 200 | | 25 V | | 50 V | 250 V | 250 V | 500V | 500V | 1000V | 2500V | 3600V | 7200V | |
| 22 | 220 | | 25 V | | 50 V | 250 V | 250 V | 500V | 500V | 1000V | 2500V | 3600V | 7200V | |
| 24 | 240 | | 25 V | | 50 V | 250 V | 250 V | 500V | 500V | 1000V | 2500V | 3600V | 7200V | |
| 27 | 270 | | 25 V | | 50 V | 250 V | 250 V | 500V | 500V | 1000V | 2500V | 3600V | 7200V | |
| 30 | 300 | | 25 V | | 50 V | 250 V | 250 V | 500V | 500V | 1000V | 2500V | 3600V | 7200V | |
| 33 | 330 | | 25 V | | 50 V | 250 V | 250 V | 500V | 500V | 1000V | 2500V | 3600V | 7200V | |

* The R05W parts, which are X7R, can only be provided with "K" or "M" tolerance.

Consult factory for Non-Standard values.

**A tolerance only available for R07S (0402) and R14S(0603) caps

LOW ESR / HIGH-Q CAPACITOR SELECTION CHART

| EIA Size Cap. Value | | Miniature Size - Portable Electronics | | | | RF Power Applications | | | | | | | | |
|------------------------|------|---------------------------------------|--------------------------------------|-------|----------------|-----------------------|----------------|----------------|----------------|----------------|----------------|-------|-------|--|
| | | 01005 (R03S) | 0201 (R05) NPO (R05L) X7R* (R05W) | | 0402 (R07S) | 0603 (R14S) | 0805 (R15S) | 0805 (R15E) | 1111 (S42E) | 2525 (S48E) | 3838 (S58E) | | | |
| Capacitance pF | Code | Voltage | | | | | | | | | | | | |
| 36 | 360 | | 25 V | | | 250 V | 250 V | 500V | 500V | 1000V | 2500V | 3600V | 7200V | |
| 39 | 390 | | 25 V | | | 250 V | 250 V | 500V | 500V | 1000V | 2500V | 3600V | 7200V | |
| 43 | 430 | | 25 V | | | 250 V | 250 V | 500V | 500V | 1000V | 2500V | 3600V | 7200V | |
| 47 | 470 | | 25 V | | | 250 V | 250 V | 500V | 500V | 1000V | 2500V | 3600V | 7200V | |
| 51 | 510 | | 25 V | | | 250 V | 250 V | 500V | 500V | 1000V | 2500V | 3600V | 7200V | |
| 56 | 560 | | 25 V | | | 250 V | 250 V | 500V | 500V | 1000V | 2500V | 3600V | 7200V | |
| 62 | 620 | | 25 V | | | 250 V | 250 V | 500V | 500V | 1000V | 2500V | 3600V | 7200V | |
| 68 | 680 | | 25 V | | | 250 V | 250 V | 500V | 500V | 1000V | 2500V | 3600V | 7200V | |
| 75 | 750 | | 25 V | | | 250 V | 250 V | 500V | 500V | 1000V | 2500V | 3600V | 7200V | |
| 82 | 820 | F | 25 V | | | 250 V | 250 V | 500V | 500V | 1000V | 2500V | 3600V | 7200V | |
| 91 | 910 | | 25 V | | | 250 V | 250 V | 500V | 500V | 1000V | 2500V | 3600V | 7200V | |
| 100 | 101 | | 25 V | | | 250 V | 250 V | 500V | 500V | 1000V | 2500V | 3600V | 7200V | |
| 110 | 111 | G | | 16 V | | | 250 V | | 300V | 500V | 2500V | 3600V | 7200V | |
| 120 | 121 | J | | | | | 250 V | | 300V | 500V | 2500V | 3600V | 7200V | |
| 130 | 131 | K | | | | | 250 V | | 300V | 500V | 2500V | 3600V | 7200V | |
| 150 | 151 | | | | | | 250 V | | 300V | 500V | 2500V | 3600V | 7200V | |
| 160 | 161 | | | | | | 250 V | | 300V | 500V | 2500V | 3600V | 7200V | |
| 180 | 181 | | | | | | 250 V | | 300V | 500V | 2500V | 3600V | 7200V | |
| 200 | 201 | | | | | | 250 V | | 300V | 500V | 2500V | 3600V | | |
| 220 | 221 | | | 16 V | | | 250 V | | 200V | 500V | 2500V | 3600V | | |
| 240 | 241 | | | | | | | | 200V | 500V | 2500V | 3600V | | |
| 270 | 271 | | | | | | | | 200V | 500V | 2500V | 3600V | | |
| 300 | 301 | | | | | | | | 200V | 500V | 1500V | 2500V | | |
| 330 | 331 | | | | | | | | 200V | 500V | 1500V | 2500V | | |
| 360 | 361 | | | | | | | | 200V | 500V | 1500V | 2500V | | |
| 390 | 391 | | | | | | | | 200V | 500V | 1500V | 2500V | | |
| 430 | 431 | | | | | | | | 200V | 500V | 1500V | 2500V | | |
| 470 | 471 | | | 16 V | | | | | 200V | 500V | 1500V | 2500V | | |
| 510 | 511 | | | | | | | | 100V | 500V | 1000V | 2500V | | |
| 560 | 561 | | | | | | | | 100V | 500V | 1000V | 2500V | | |
| 620 | 621 | | | | | | | | 100V | 500V | 1000V | 2500V | | |
| 680 | 681 | | | 16 V | | | | | 50V | | 1000V | 2500V | | |
| 750 | 751 | | | | | | | | 50V | | 1000V | 2500V | | |
| 820 | 821 | G | | 16 V | | | | | 50V | | 1000V | 2500V | | |
| 910 | 911 | | | | | | | | 50V | | 1000V | 1000V | | |
| 1000 | 102 | J | | 10 V | | | | | 50V | | 1000V | 1000V | | |
| 1200 | 122 | K | | | | | | | | | 1000V | 1000V | | |
| 1500 | 152 | | | | | | | | | | 500V | 1000V | | |
| 1800 | 182 | | | | | | | | | | 500V | 1000V | | |
| 2200 | 222 | | | 10 V | | | | | | | 300V | 1000V | | |
| 2700 | 272 | | | | | | | | | | 300V | 500V | | |
| 3300 | 332 | | | | | | | | | | | 500V | | |
| 3900 | 392 | | | | | | | | | | | 500V | | |
| 4700 | 472 | | | 10 V | | | | | | | | 500V | | |
| 5100 | 512 | | | | | | | | | | | 500V | | |
| 10000 | 103 | | | 6.3 V | | | | | | | | | | |

* The R05W parts, which are X7R, can only be provided with "K" and "M" tolerance.
Consult factory for Non-Standard values.

DIELECTRIC CHARACTERISTICS

NPO

X7R

| | | |
|---------------------------------|--|--|
| TEMPERATURE COEFFICIENT: | 0 ± 30ppm /°C, -55 to 125°C | ± 15%, -55 to 125°C |
| QUALITY FACTOR / DF: | Q > 1,000 @ 1 MHz, Typical 10,000 | 16VDC DF ≤ 3.5% @ 1 KHz, 25°C 10VDC DF ≤ 5.0% @ 1 KHz, 25°C |
| INSULATION RESISTANCE: | > 100 GΩ @ 25°C, WVDC; 125°C IR is 10% of 25°C rating | > 500 ΩF* or 10 GΩ* @ 25°C, WVDC; 125°C IR is 10% of 25°C rating * whichever is less |
| DIELECTRIC STRENGTH: | 500 V ≤ 2.5 X WVDC Min., 25°C, 50 mA max 1000 V ≤ 1.5 X WVDC Min., 25°C, 50 mA max > 1500 = 1 X WVDC Min., 25°C, 50 mA max | 2.5 X WVDC Min., 25°C, 50 mA max 1KHz ±50Hz, 1.0±0.2 VRMS, 25°C 100 - 10,000 pF |
| TEST PARAMETERS:: | 1MHz ±50kHz, 1.0±0.2 VRMS, 25°C | |
| AVAILABLE CAPACITANCE: | | |
| Size 01005: | 0.2 - 10 pF | Size 0805: 0.3 - 220 pF |
| Size 0201: | 0.2 - 100 pF | Size 1111: 0.2 - 1000 pF |
| Size 0402: | 0.2 - 33 pF | Size 2525: 1.0 - 2700 pF |
| Size 0603: | 0.2 - 100 pF | Size 3838: 1.0 - 5100 pF |

MECHANICAL & ENVIRONMENTAL CHARACTERISTICS

| | SPECIFICATION | TEST PARAMETERS |
|--------------------------------------|--|---|
| SOLDERABILITY: | Solder coverage ≥ 90% of metalized areas No termination degradation | Preheat chip to 120°-150°C for 60 sec., dip terminals in rosin flux then dip in Sn62 solder @ 240°±5°C for 5±1 sec |
| RESISTANCE TO SOLDERING HEAT: | No mechanical damage Capacitance change: ±2.5% or 0.25pF Q>500 I.R. >10 G Ohms Breakdown voltage: 2.5 x WVDC | Preheat device to 80°-100°C for 60 sec. followed by 150°-180°C for 60 sec. Dip in 260°±5°C solder for 10±1 sec. Measure after 24±2 hour cooling period |
| TERMINAL ADHESION: | Termination should not pull off. Ceramic should remain undamaged. | Linear pull force* exerted on axial leads soldered to each terminal. *0402 ≥ 2.0lbs, 0603 ≥ 2.0lbs (min.) |
| PCB DEFLECTION: | No mechanical damage. Capacitance change: 2% or 0.5pF Max | Glass epoxy PCB: 0.5 mm deflection |
| LIFE TEST: | MIL-STD-202, Method 108I No mechanical damage Capacitance change: ±3.0% or 0.3 pF Q>500 I.R. >1 G Ohms Breakdown voltage: 2.5 x WVDC | Applied voltage: 120% of WDVC for capacitors rated at 500 volts DC or less. 100% of WDVC for capacitors rated at 1250 volts DC or less. Temperature: 125°±3°C Test time: 1000+48-0 hours |
| THERMAL CYCLE: | No mechanical damage. Capacitance change: ±2.5% or 0.25pF Q>2000 I.R. >10 G Ohms Breakdown voltage: 2.5 x WVDC | 5 cycles of: 30±3 minutes @ -55°+0/-3°C, 2-3 min. @ 25°C, 30±3 min. @ +125°+3/-0°C, 2-3 min. @ 25°C Measure after 24±2 hour cooling period |
| HUMIDITY, STEADY STATE: | No mechanical damage. Capacitance change: ±5.0% or 0.50pF max. Q>300 I.R. ≥ 1 G-Ohm Breakdown voltage: 2.5 x WVDC | Relative humidity: 90-95% Temperature: 40°±2°C Test time: 500 +12/-0 Hours Measure after 24±2 hour cooling period |
| HUMIDITY, LOW VOLTAGE: | No mechanical damage. Capacitance change: ±5.0% or 0.50pF max. Q>300 I.R. = 1 G-Ohm min. Breakdown voltage: 2.5 x WVDC | Applied voltage: 1.5 VDC, 50 mA max. Relative humidity: 85±2% Temperature: 40°±2°C Test time: 240 +12/-0 Hours Measure after 24±2 hour cooling period |
| VIBRATION: | No mechanical damage. Capacitance change: ±2.5% or 0.25pF Q>1000 I.R. ≥ 10 G-Ohm Breakdown voltage: 2.5 x WVDC | Cycle performed for 2 hours in each of three perpendicular directions Frequency range 10Hz to 55 Hz to 10 Hz traversed in 1 minute. Harmonic motion amplitude: 1.5mm |

MECHANICAL CHARACTERISTICS

| Size | Units | Length | Width | Thickness | End Band |
|---------------|-------|--------------|--------------|------------------|-------------|
| EIA 01005 | In | .016 ±.001 | .008 ±.001 | .008 ±.001 | .006 Max. |
| Metric (0402) | mm | (0.40 ±0.03) | (0.20 ±0.03) | (0.20 ±0.03) | (0.15 Max.) |
| EIA 0201 | In | .024 ±.001 | .012 ±.001 | .012 ±.001 | .008 Max. |
| Metric (0603) | mm | (0.60 ±0.03) | (0.30 ±0.03) | (0.30 ±0.03) | (0.20 Max.) |
| EIA 0402 | In | .040 ±.004 | .020 ±.004 | .020 ±.004 | .010 ±.006 |
| Metric (1005) | mm | (1.02 ±0.1) | (0.51 ±0.1) | (0.51 ±0.1) | (0.25 ±.15) |
| EIA 0603 | In | .062 ±.006 | .032 ±.006 | .030 +.005/-.003 | .014 ±.006 |
| Metric (1608) | mm | (1.57 ±0.15) | (0.81 ±0.15) | (0.76 +.13-.08) | (0.35 ±.15) |
| EIA 0805 | In | .080 ±.008 | .050 ±.008 | .040 ±.006 | .020 ±.010 |
| Metric (2012) | mm | (2.03 ±0.20) | (1.27 ±0.20) | (1.02 ±.15) | (0.50 ±.25) |

HORIZONTAL AND VERTICAL ORIENTED CAPACITORS

Horizontal Electrode Orientation

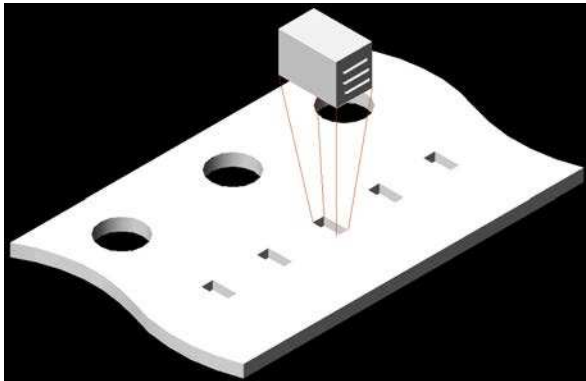

Vertical Electrode Orientation

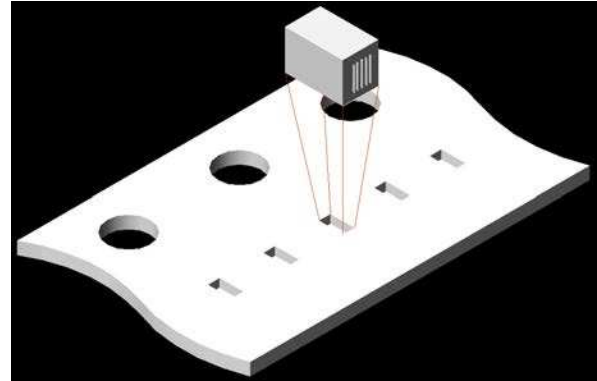

APPLICATIONS & FEATURES

| | |
|---------------|--|
| Size: | EIA 0201, 0402 |
| Performance: | SRF's up to 20 GHz, Ultra High Q, Tight tolerance, Ultralow ESR |
| Termination: | Ni/Au, Ni/Sn, Ni/SnPb |
| Applications: | High Frequency Wireless Communications, Portable Wireless Products, Battery Powered Products |

RoHS Compliant

BENEFITS OF USING ORIENTED CAPACITORS

- Consistent Orientation - Improved repeatability of production circuits.
- Consistent Orientation - More consistent filter performance.
- Vertical Orientation - The elimination of parallel frequencies.
- Vertical Orientation - Lower inductance for a given capacitor.
- Horizontal Orientation - Lower coupling between adjacent capacitors.

E-SERIES TERMINATIONS AND LEADS

| Termination | Size | Units | L | Tol | W | Tol | T | E / B | Tol |
|--------------|------|-------|-------|---------------|-------|----------|------------|------------|-----------|
| V, T U, C | S42E | In | 0.110 | +0.020 -0.010 | 0.110 | +/- .015 | 0.086 Max. | 0.015 Typ. | +/- 0.008 |
| | | mm | 2.79 | +0.51 -0.25 | 2.79 | +/- 0.38 | 2.18 Max. | 0.38 Typ. | +/- 0.20 |
| | S48E | In | 0.230 | +0.025 -0.010 | 0.250 | +/- .015 | 0.150 Max. | 0.025 Typ. | |
| | | mm | 5.84 | +0.63 -0.25 | 6.35 | +/- 0.38 | 3.81 Max. | 0.63 Typ. | |
| | S58E | In | 0.380 | +0.015 -0.010 | 0.380 | +/- .010 | 0.170 Max. | 0.025 Typ. | |
| | | mm | 9.65 | +0.38 -0.25 | 9.65 | +/- 0.25 | 4.32 Max. | 0.63 Typ. | |

For all E-Series Models:

OPERATING TEMP. :

-55 to +125°C

INSULATION RESISTANCE:

>1000 ΩF or >10 GΩ,
whichever is less
@ 25°C WVDC

TEMPERATURE COEFFICIENT:

0 ± 30ppm /°C, -55 to 125°C

DISSIPATION FACTOR (TYP):

< 0.05% @ 1 MHz

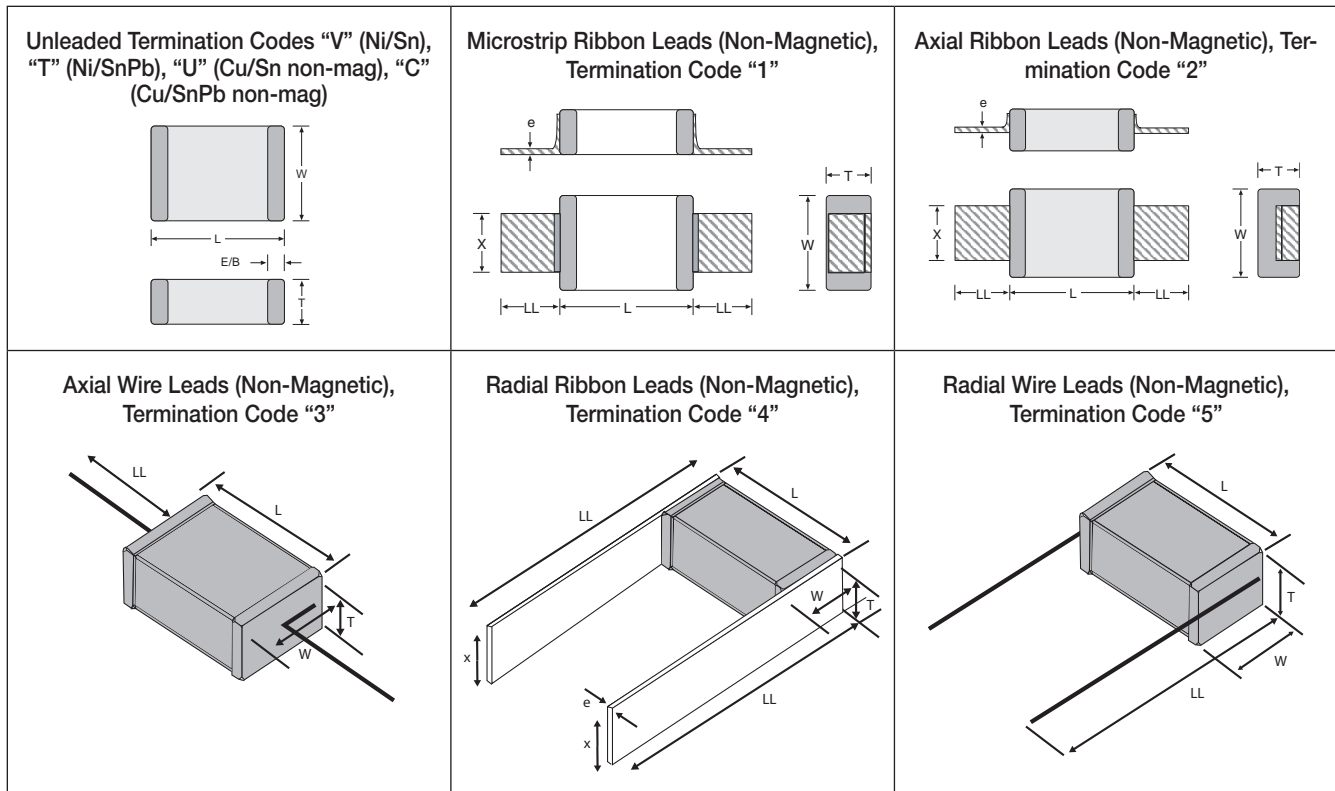

| Lead | Size | Units | L | Tol | W | Tol | T (max) | E/B (typ) | LL(min) | X | Tol | e | Tol |
|------|-------------------|-------|-------|------------------|-------|-----------|---------|-----------|---------|-----------------------------------|-----------|-------|-----------|
| 1 | S42E | In | 0.135 | +/- .015 | 0.110 | +/- .020 | 0.086 | 0.015 | 0.25 | 0.093 | +/-0.005 | 0.004 | +/- 0.001 |
| | | mm | 3.43 | +/- 0.38 | 2.79 | +/- 0.51 | 3.05 | 0.38 | 6.35 | 2.36 | +/- 0.13 | 0.102 | +/- 0.025 |
| | S48E | In | 0.245 | +/- 0.025 | 0.250 | +/- 0.015 | 0.160 | 0.025 | 0.50 | 0.240 | +/- 0.005 | 0.004 | +/- 0.001 |
| | | mm | 6.22 | +/- 0.64 | 6.35 | +/- 0.38 | 3.81 | 0.63 | 12.7 | 6.10 | +/- 0.13 | 0.102 | +/- 0.025 |
| | S58E | In | 0.38 | +0.035 / - 0.010 | 0.38 | +/- 0.010 | 0.170 | 0.04 MAX. | 0.750 | 0.35 | +/- 0.010 | 0.010 | +/- 0.005 |
| | | mm | 9.65 | +0.89 / -0.25 | 9.65 | +/- 0.25 | 4.32 | 1.02 MAX. | 19.05 | 8.89 | +/- 0.25 | 0.25 | +/- 0.13 |
| 2 | S42E | In | 0.135 | +/- .015 | 0.110 | +/- .020 | 0.086 | 0.015 | 0.25 | 0.093 | +/-0.005 | 0.004 | +/- 0.001 |
| | | mm | 3.43 | +/- 0.38 | 2.79 | +/- 0.51 | 2.18 | 0.38 | 6.35 | 2.36 | +/- 0.13 | 0.102 | +/- 0.025 |
| | S48E | In | 0.245 | +/- 0.025 | 0.250 | +/- 0.015 | 0.160 | 0.025 | 0.50 | 0.240 | +/- 0.005 | 0.004 | +/- 0.001 |
| | | mm | 6.22 | +/- 0.64 | 6.35 | +/- 0.38 | 3.81 | 0.63 | 12.7 | 6.10 | +/- 0.13 | 0.102 | +/- 0.025 |
| | S58E | In | 0.38 | +0.035 / - 0.010 | 0.38 | +/- 0.010 | 0.170 | 0.04 MAX. | 0.750 | 0.35 | +/- 0.010 | 0.010 | +/- 0.005 |
| | | mm | 9.65 | +0.89 / -0.25 | 9.65 | +/- 0.25 | 4.32 | 1.02 MAX. | 19.05 | 8.89 | +/- 0.25 | 0.25 | +/- 0.13 |
| 3 | S42E S48E S58E | In | 0.145 | +/- .020 | 0.110 | +/- .015 | 0.086 | | 0.50 | #26 AWG, .016 (.406) dia. nominal | | | |
| | | mm | 3.68 | +/- 0.51 | 2.79 | +/- 0.38 | 2.18 | | 12.70 | | | | |
| 4 | S42E S48E S58E | In | 0.135 | +/- .015 | 0.110 | +/- .015 | 0.086 | | 0.25 | 0.093 | +/-0.005 | 0.004 | +/- 0.001 |
| | | mm | 3.43 | +/- 0.38 | 2.79 | +/- 0.38 | 2.18 | | 6.35 | 2.36 | +/- 0.13 | 0.102 | +/- 0.025 |
| 5 | S42E S48E S58E | In | 0.145 | +/- .020 | 0.110 | +/- .015 | 0.086 | | 0.50 | #26 AWG, .016 (.406) dia. nominal | | | |
| | | mm | 3.68 | +/- 0.51 | 2.79 | +/- 0.38 | 2.18 | | 12.70 | | | | |

SERIES RESONANCE CHART

Typical Series Resonant Frequency (Series Mounted)

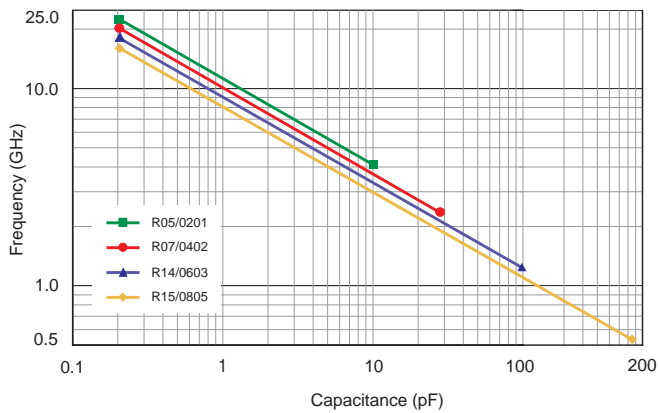

RF CHARACTERISTICS - L-SERIES

ESR vs Frequency: 0201/R05L

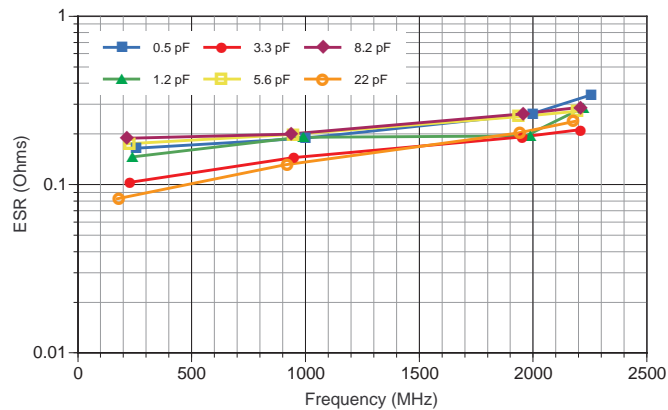

Q vs Frequency: 0201/R05L

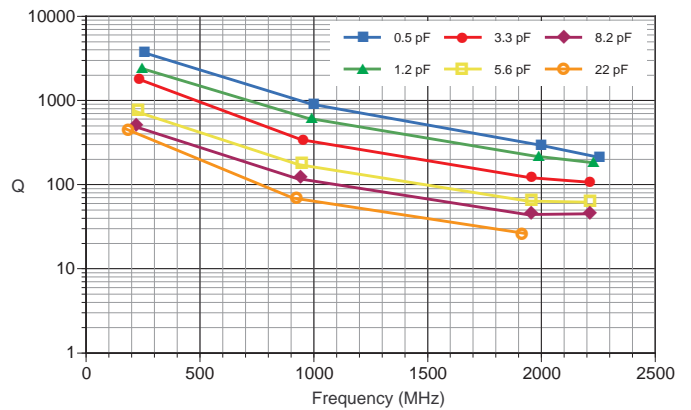

ESR vs Capacitance: 0201/R05L

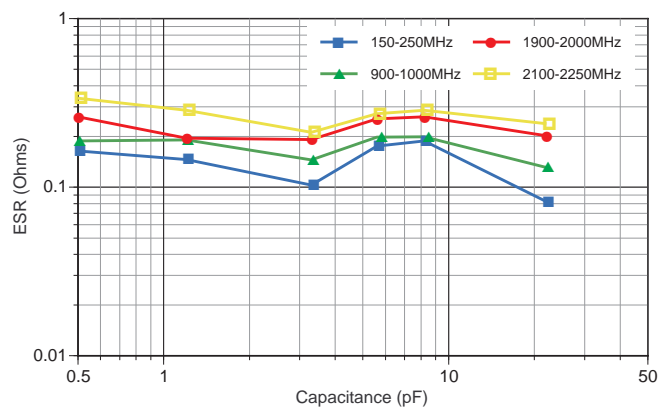

Q vs Capacitance: 0201/R05L

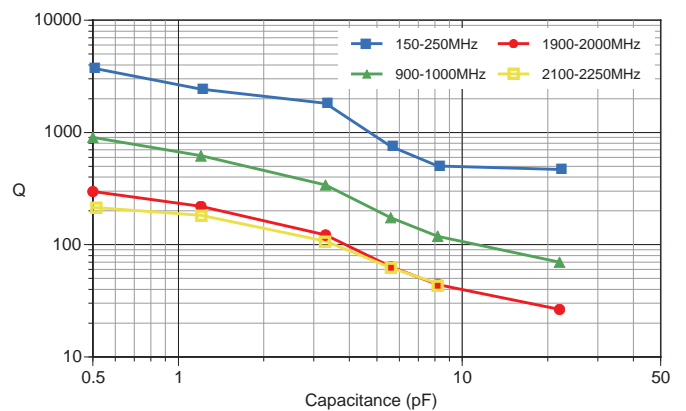

S-SERIES RF CHARACTERISTICS VERSUS FREQUENCY

Equivalent Series Resistance: 0402/R07S

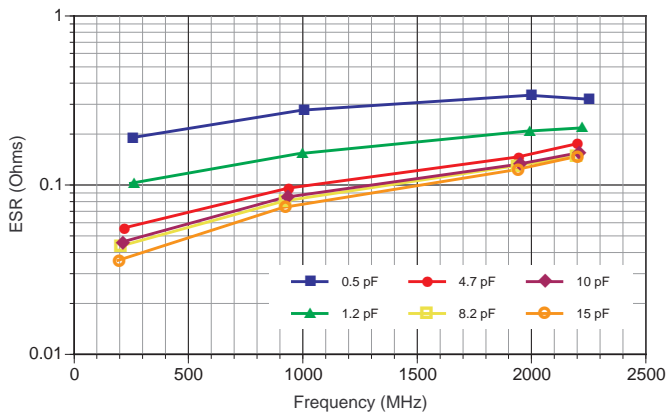

Q Factor: 0402/R07S

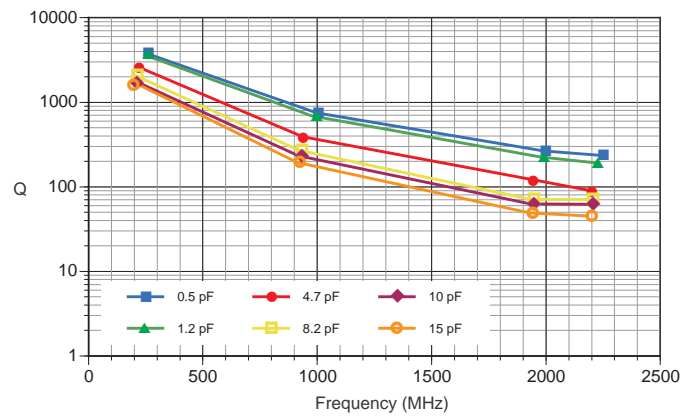

Equivalent Series Resistance: 0603/R14S

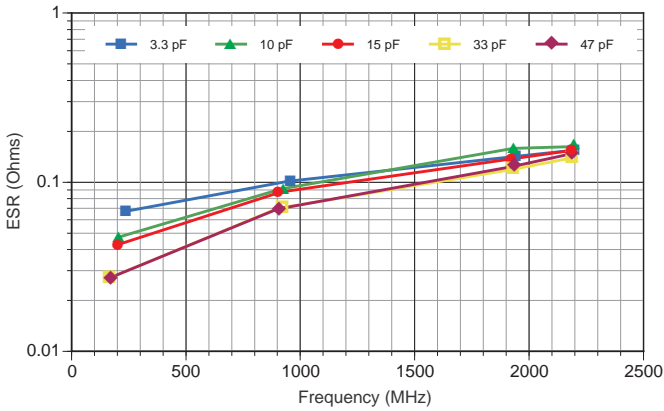

Q Factor: 0603/R14S

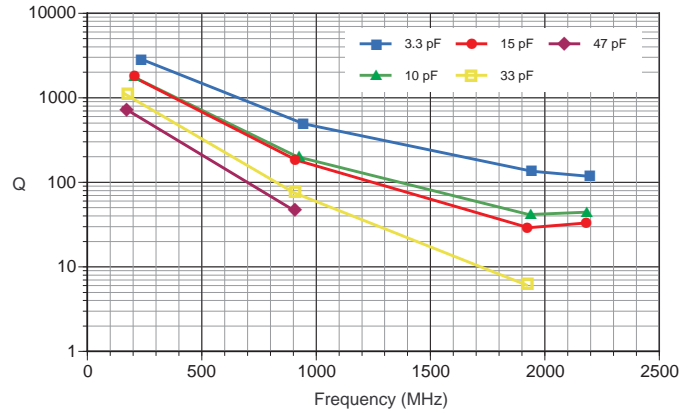

Equivalent Series Resistance: 0805/R15S

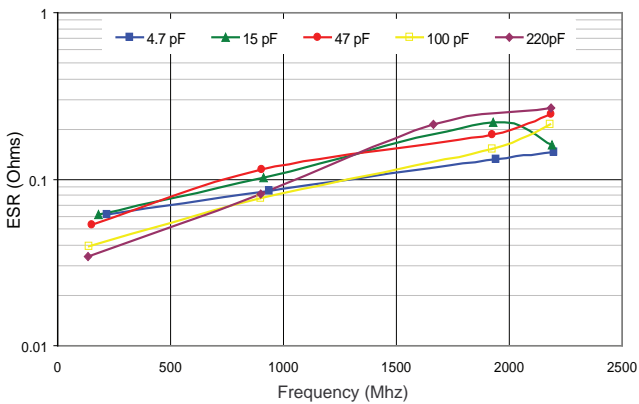

Q Factor: 0805/R15S

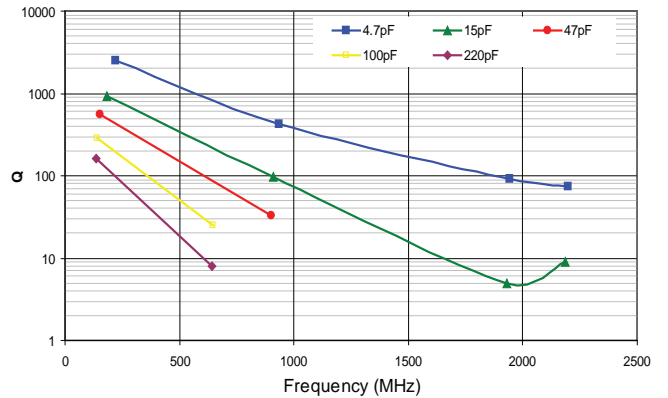

Measurements performed on a Boonton 34A Resonant Coaxial Line and represent typical capacitor performance.

S-SERIES RF CHARACTERISTICS VERSUS CAPACITANCE

Equivalent Series Resistance: 0402/R07S

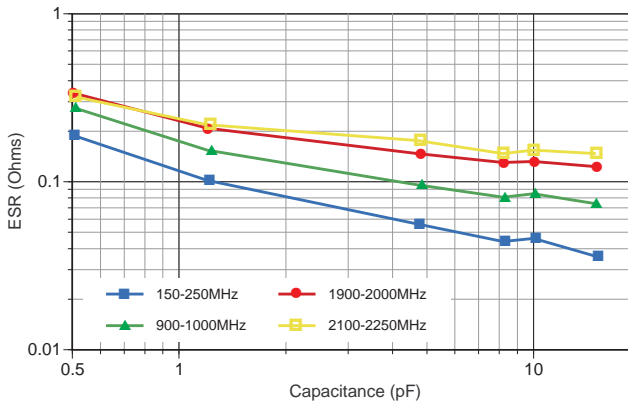

Q Factor: 0402/R07S

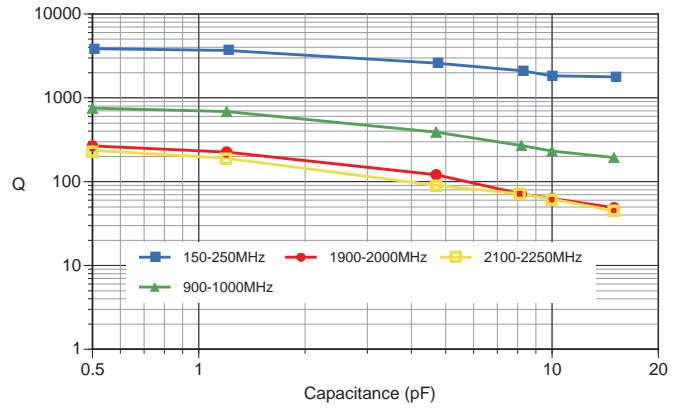

Equivalent Series Resistance: 0603/R14S

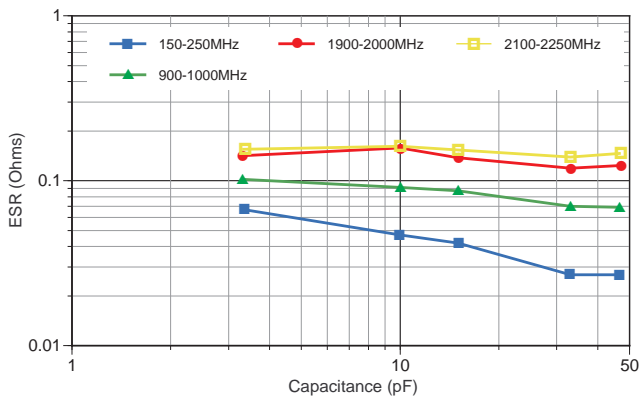

Q Factor: 0603/R14S

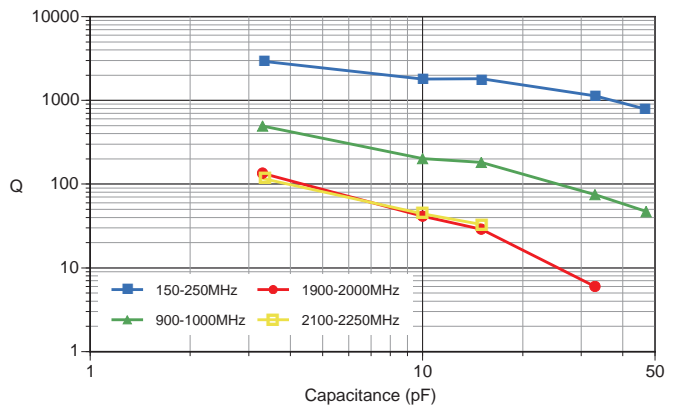

Equivalent Series Resistance: 0805/R15S

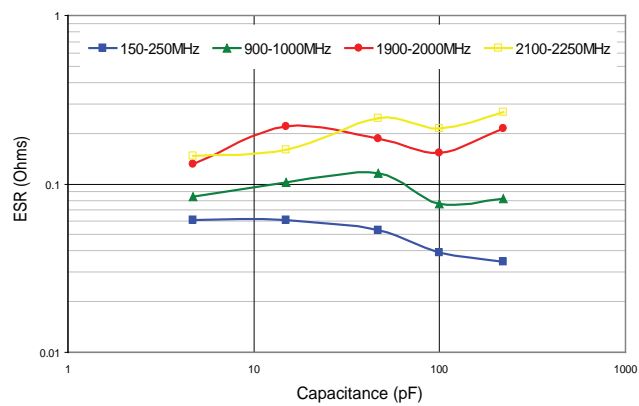

Q Factor: 0805/R15S

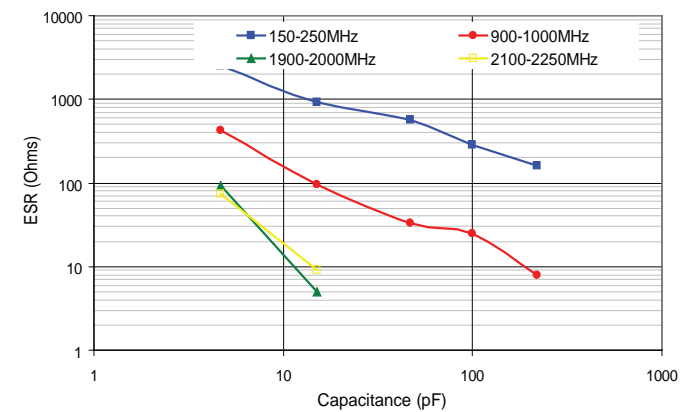

Measurements performed on a Boonton 34A Resonant Coaxial Line and represent typical capacitor performance.

S42E SERIES RF CHARACTERISTICS VERSUS FREQUENCY

Equivalent Series Resistance: 1111/S42E

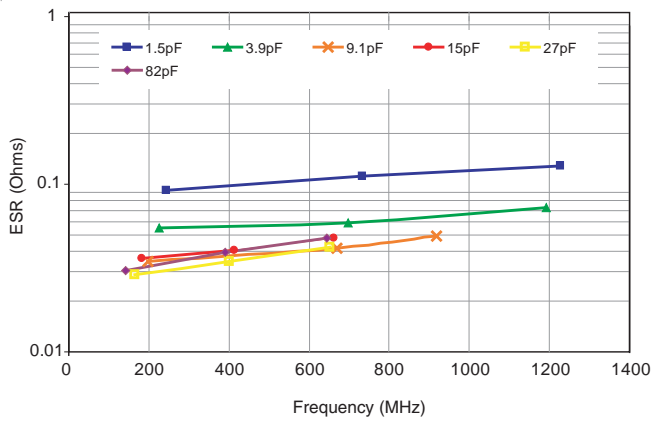

Q Factor: 1111/S42E

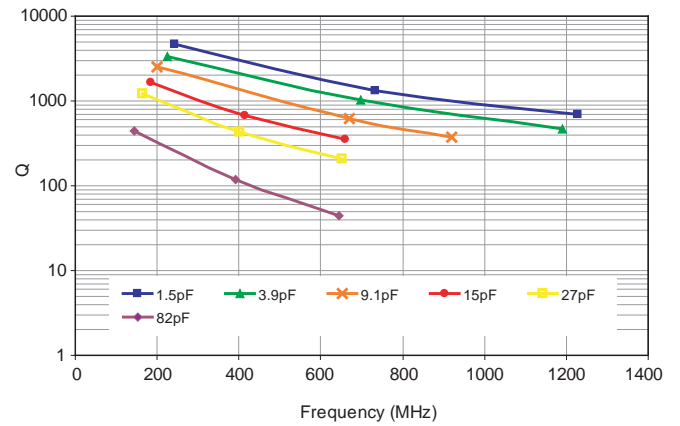

S42E SERIES RF CHARACTERISTICS VERSUS CAPACITANCE

S42E Equivalent Series Resistance vs Capacitance, Typical

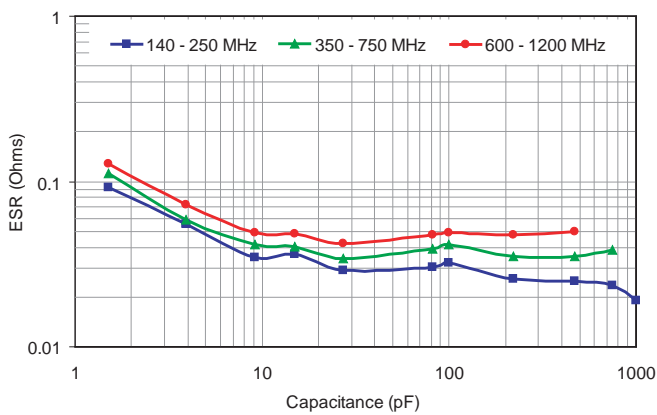

S42E Q vs. Capacitance, Typical

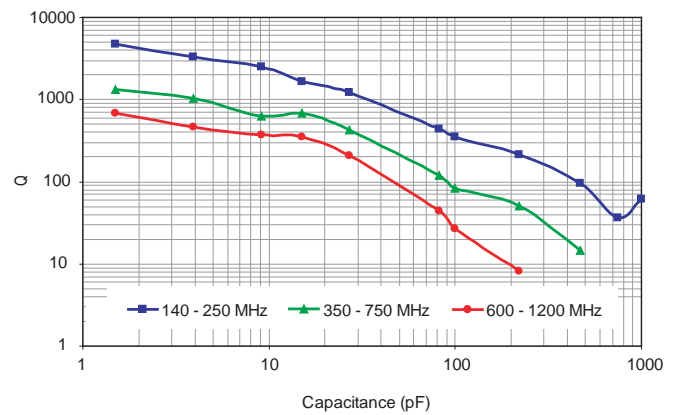

S42E SRF (Series Mount), Typical

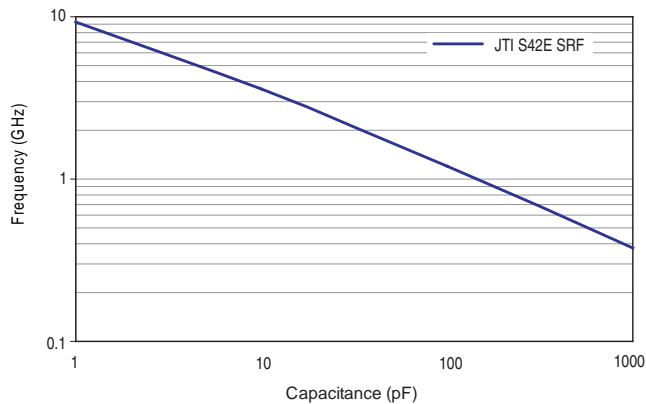

SRF (Shunt Mount), S48E, Typical (Preliminary)

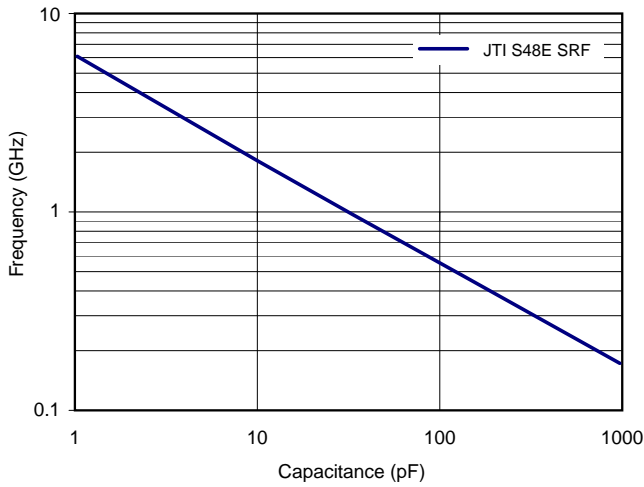

As measured on a 8720C VNA, using a Shunt-Through fixture, and using the S11 magnitude dip to determine the SRF

Current Rating vs. Capacitance, S48E, Typical (Preliminary)

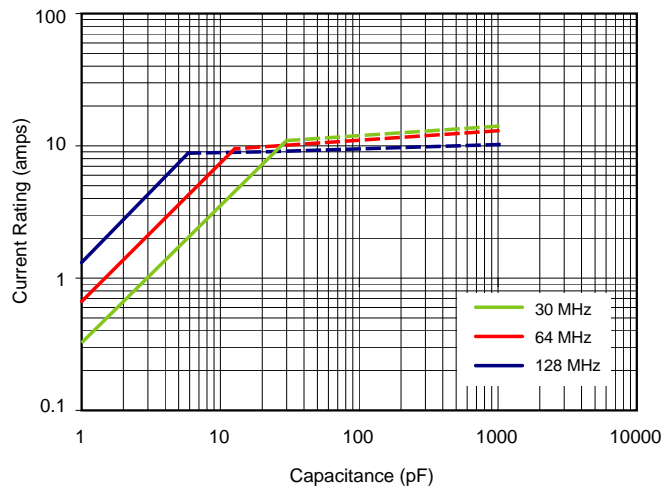

Solid traces show voltage limited current (Vrms)

Dotted traces show power dissipation limited current (Based on 4 Watts Power Dissipation, and 125 degrees C case temp.)

S48E Q vs. Capacitance, Typical (Preliminary)

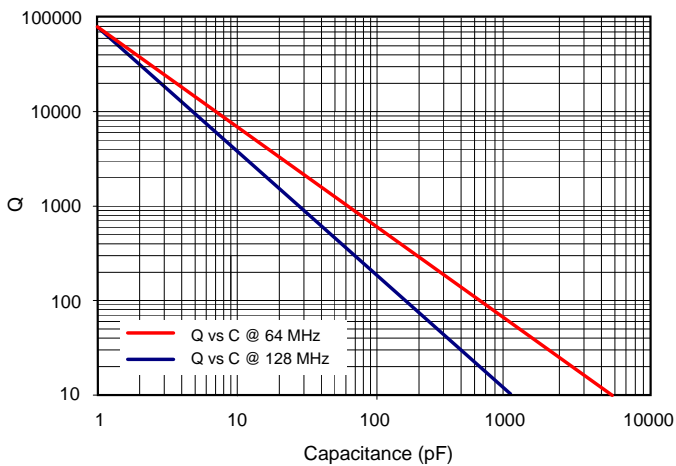

As measured on a 4287A LCR meter, using a 16092A fixture

S48E ESR vs. Capacitance, Typical (Preliminary)

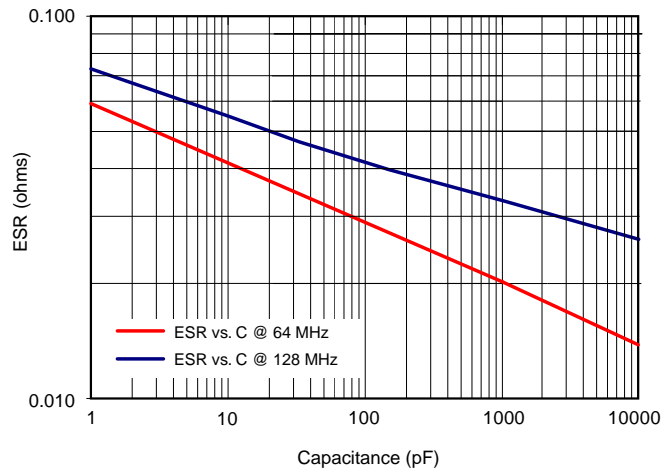

As measured on a 4287A LCR meter, using a 16092A fixture

JTI S48E GRAPHICAL DATA

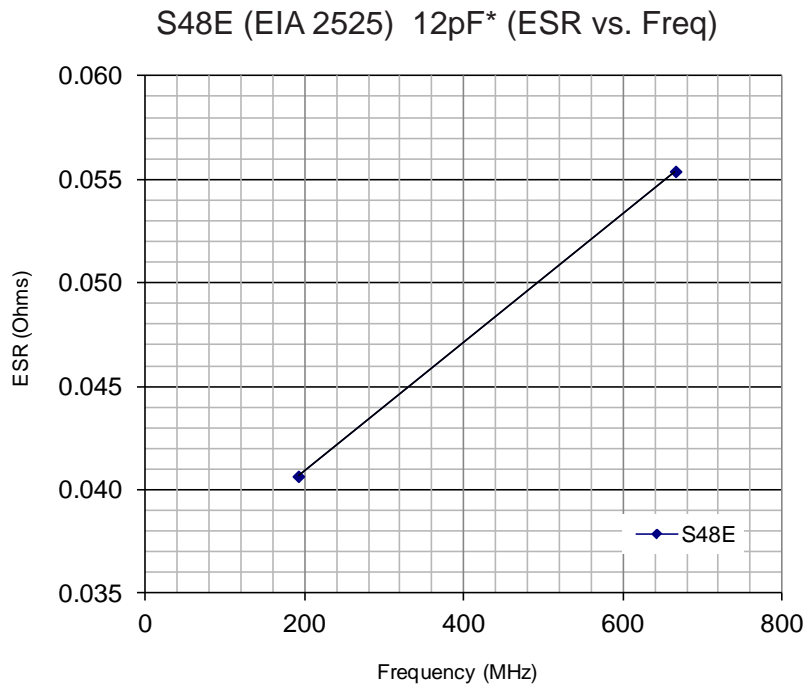

*Actual data from Boonton 34A resonant line.

JTI S58E GRAPHICAL DATA

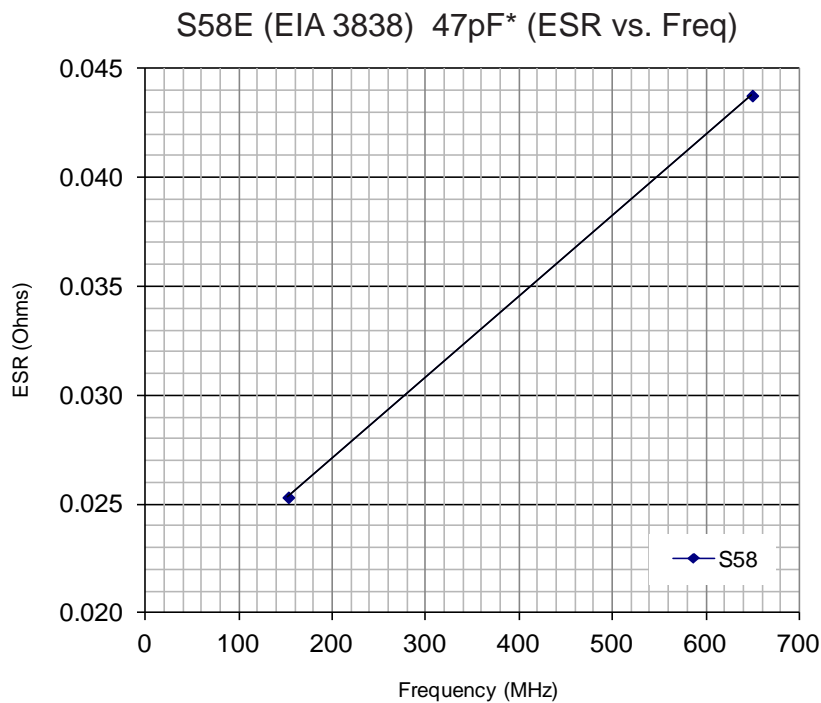

*Actual data from Boonton 34A resonant line.