

LISA2-CLIP16-RE MINIATURE LENS FOR LUXEON REBEL SERIES OF LEDS



- Lens material optical grade PMMA with high UV and temperature resistance (105°C/220°F). Lens holder molded of high quality black PC (120°C/248°F).
- High optical efficiency, up to 90%.
- Integrated holder with small snap clips. See drawing below for more details of fastening the holder to PCB.
- Very small and compact dimensions: Diameter 9.9 mm, height 6.8 mm.

LENS TYPES

NAME	ORDERING CODE	FWHM Angle
Lisa2-Clip16 Real Spot	FA11086_Lisa2-RS-clip16-RE	±9°
Lisa2-Clip16 Medium	FA11072_Lisa2-M-clip16-RE	±13°
Lisa2-Clip16 Oval	FA11122_Lisa2-O-clip16-RE	±10° x ±24°
Lisa2-Clip16 Wide	FA11073_Lisa2-W-clip16-RE	±19°

© Ledil Oy – PRELIMINARY - Subject to change without prior notice

MEASUREMENT DATA

Relative Intensity of FA11056_Lisa2-RS-Pin-RE

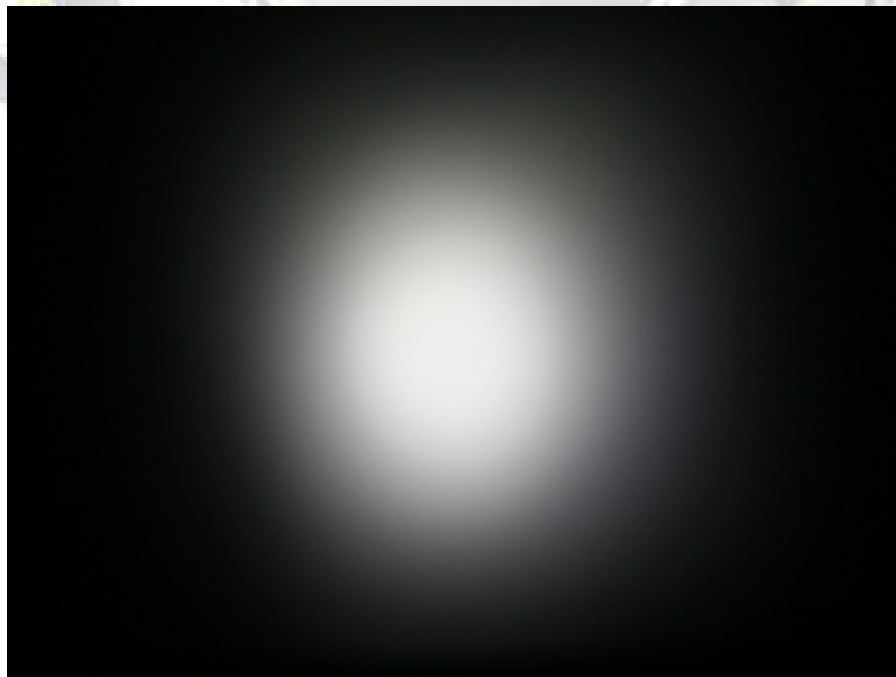
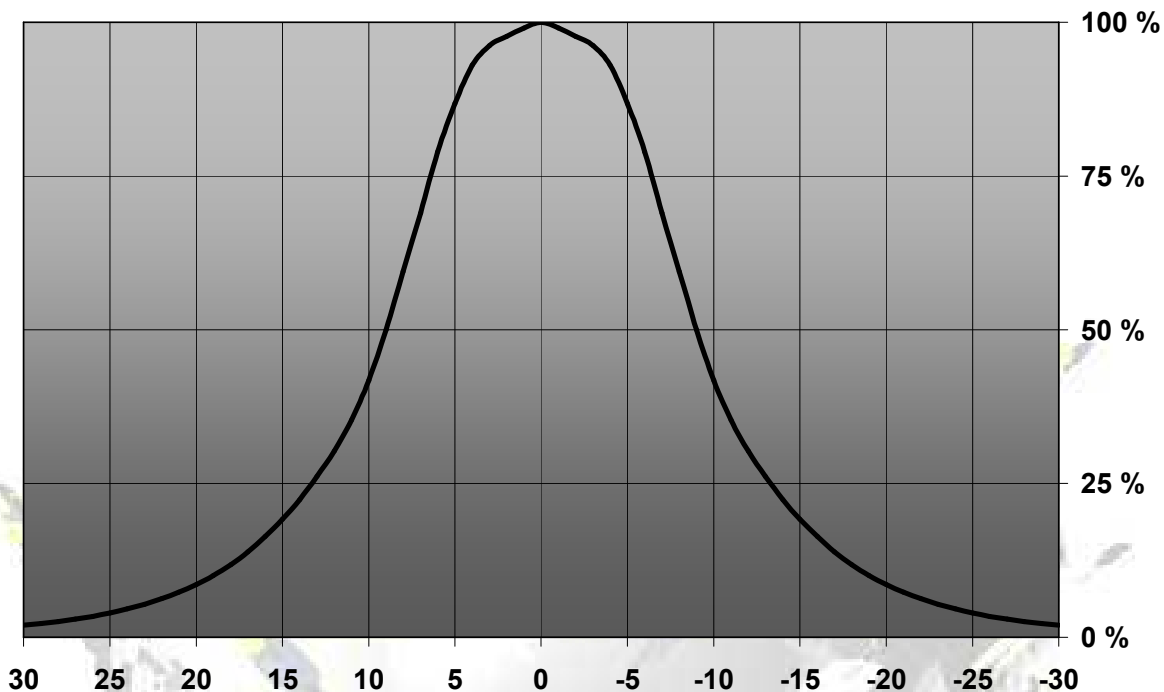

© Ledil Oy – PRELIMINARY - Subject to change without prior notice

Relative Intensity of FA10992_Lisa2-M-Pin-RE

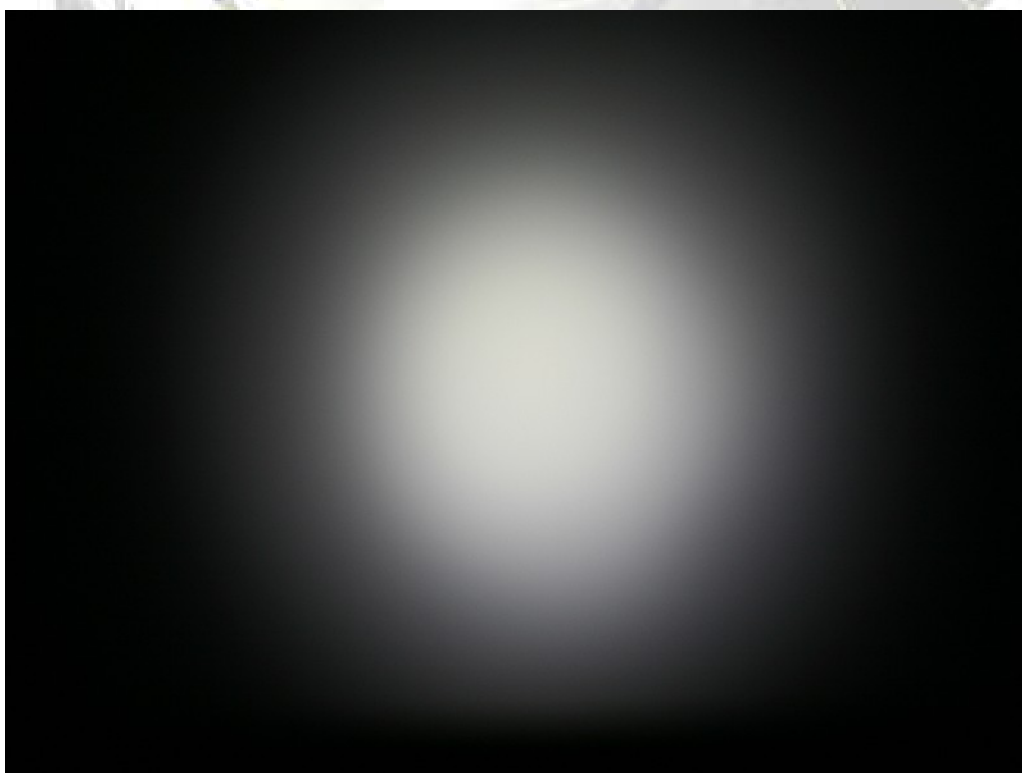
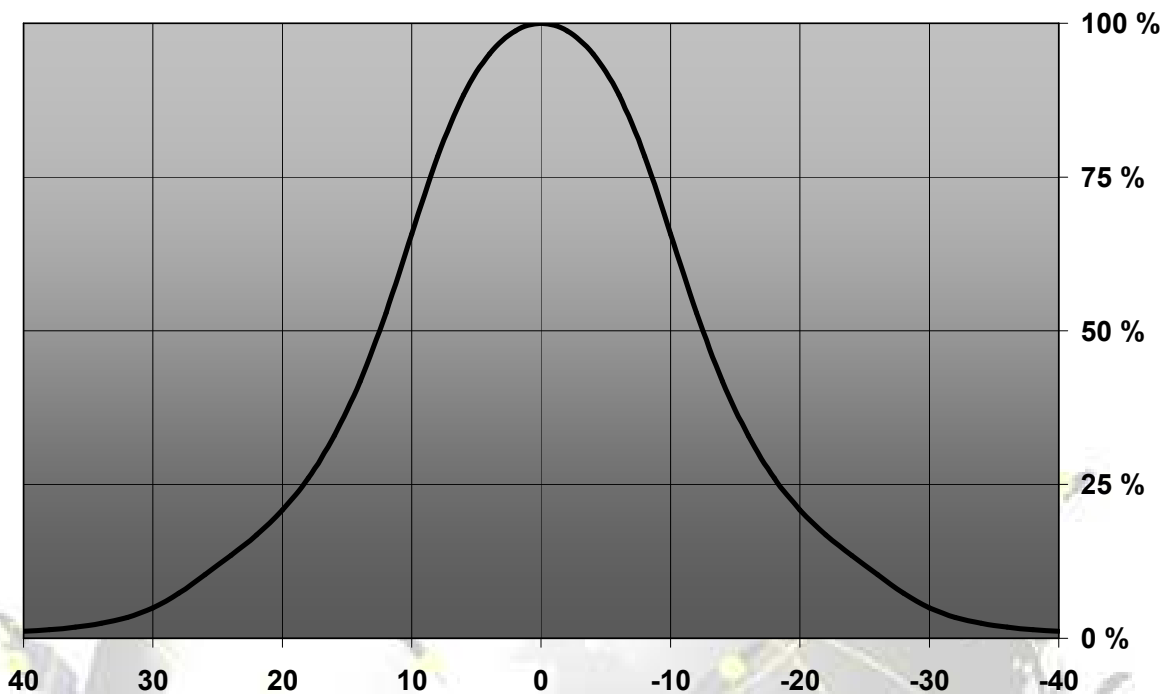

© Ledil Oy – PRELIMINARY - Subject to change without prior notice

Relative intensity of FA11126_Lisa2-O-Pin-RE

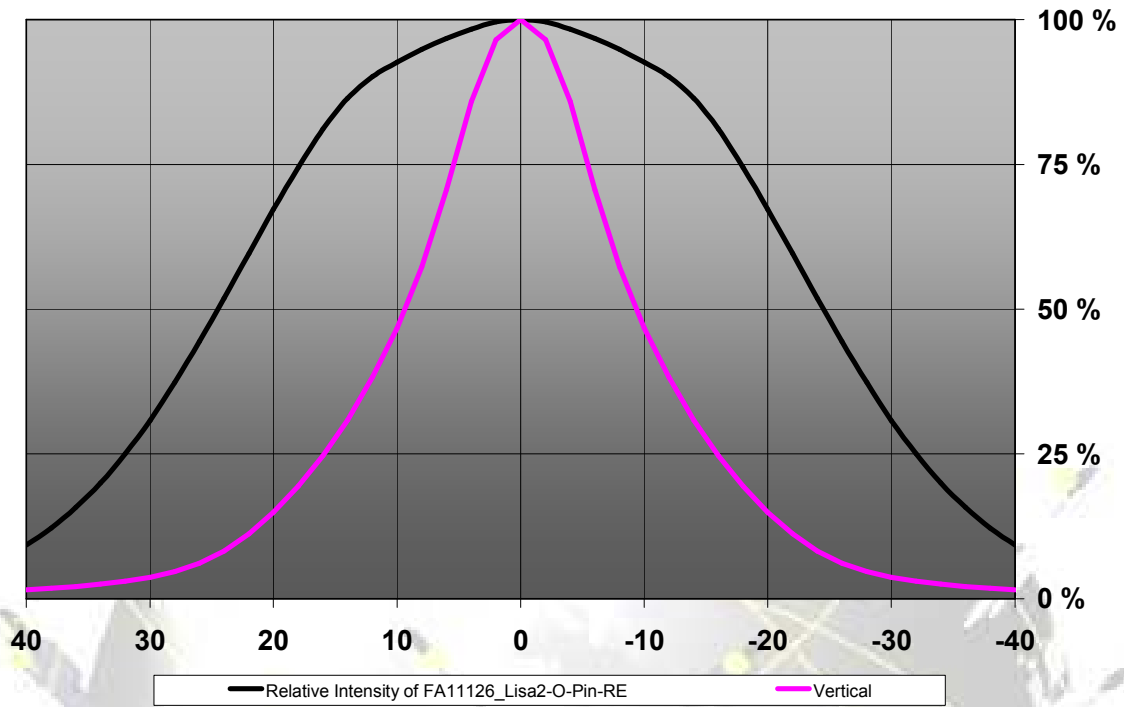

© Ledil Oy – PRELIMINARY - Subject to change without prior notice

Relative Intensity of FA10993_Lisa2-W-Pin-RE

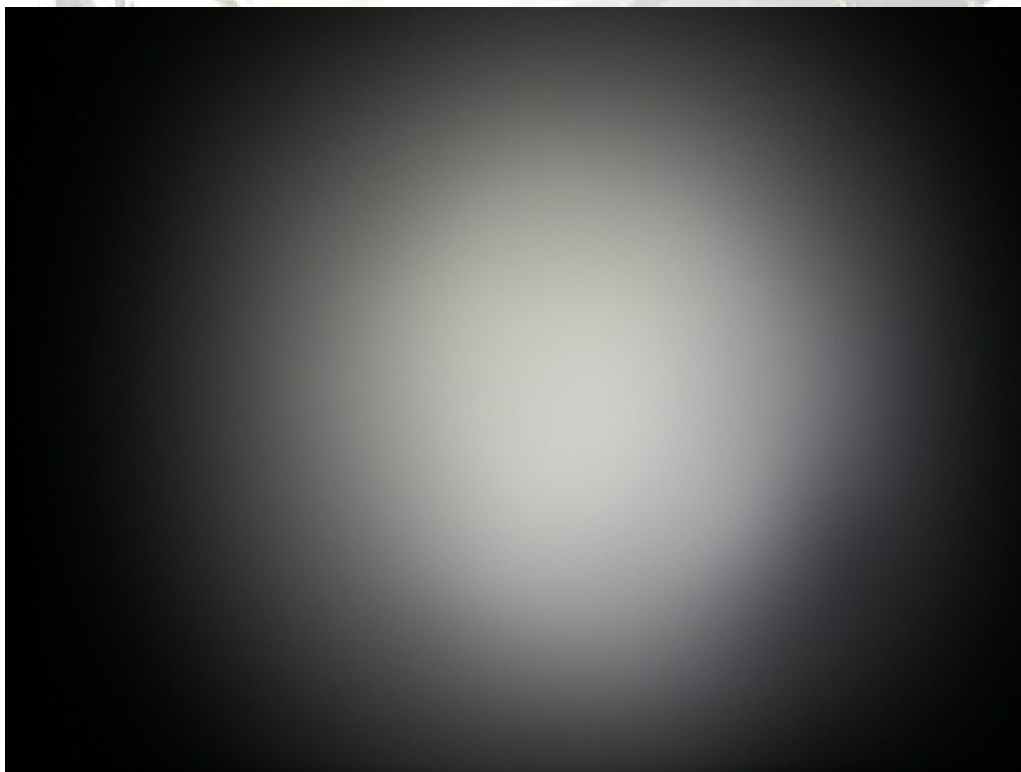
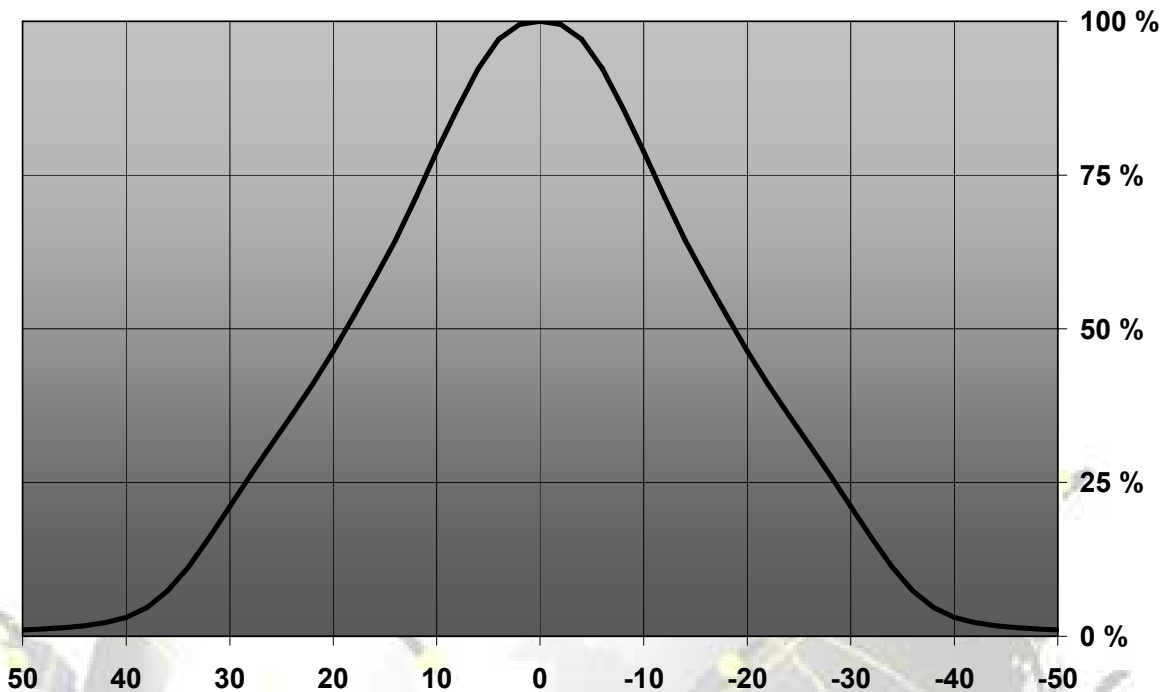

© Ledil Oy – PRELIMINARY - Subject to change without prior notice

DRAWINGS

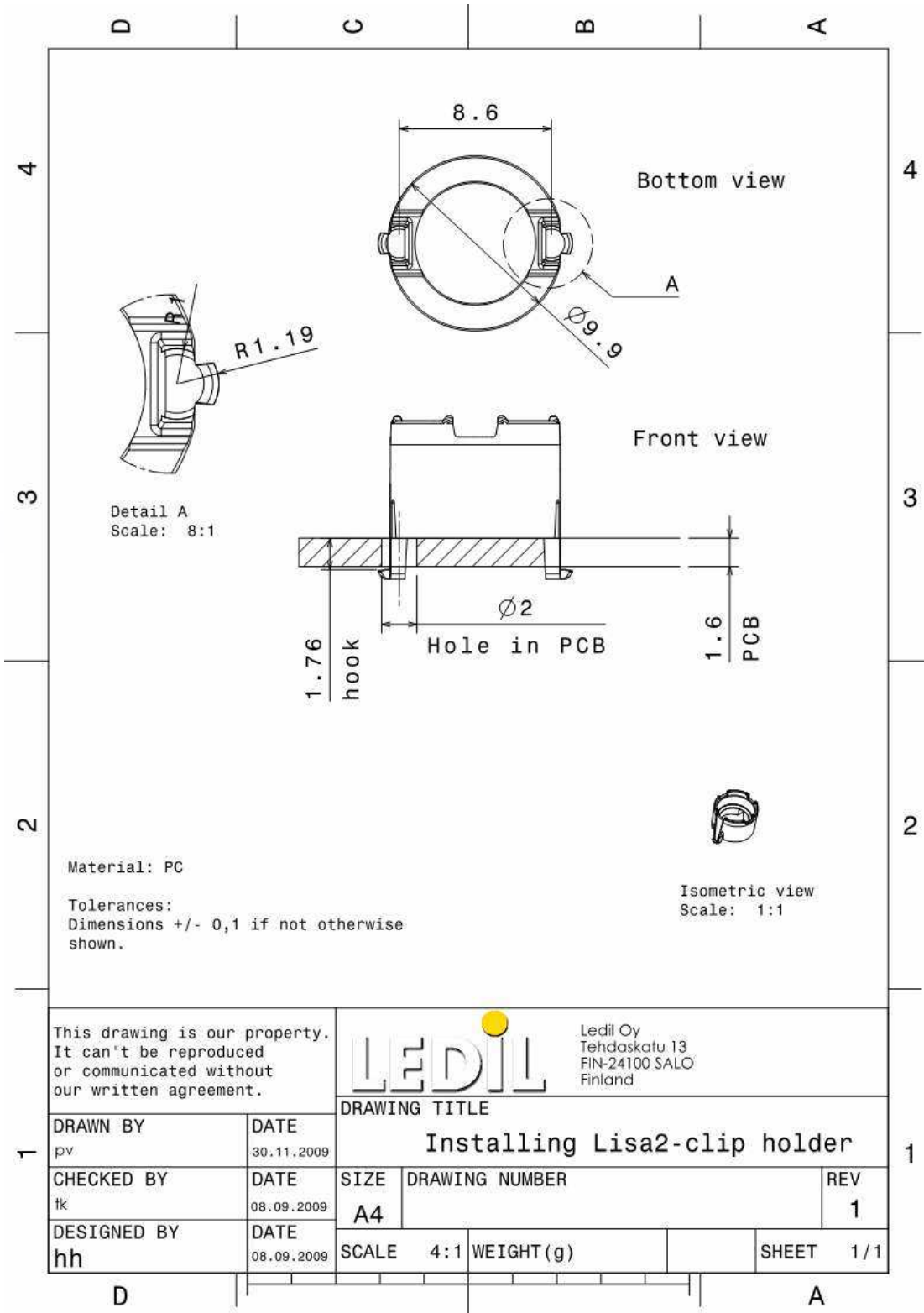

© Ledil Oy – PRELIMINARY - Subject to change without prior notice