

MX6-7 lenses for CREE MX6 LEDs



- Lens material optical grade PMMA with high UV and temperature resistance (105°C/220°F)
- High optical efficiency, >85%
- No lens holder. Attaching of the lens to customer's heat sink by gluing. For detailed mounting information, please look at the drawing
- Diameter 38 mm (MR11)

LENS TYPES

NAME	ORDERING CODE	FWHM Angle
MX6 Medium	C10373_MX6-7-M	±10°
MX6 MD	C10633_MX6-7-MD	±13°
MX6 Wide	C10585_MX6-7-W	±18°
MX6 WW	C10586_MX6-7-WW	±27°

© Ledil Oy – PRELIMINARY - Subject to change without prior notice

MEASUREMENT DATA

Relative Intensity of C10373_MX6-7-M

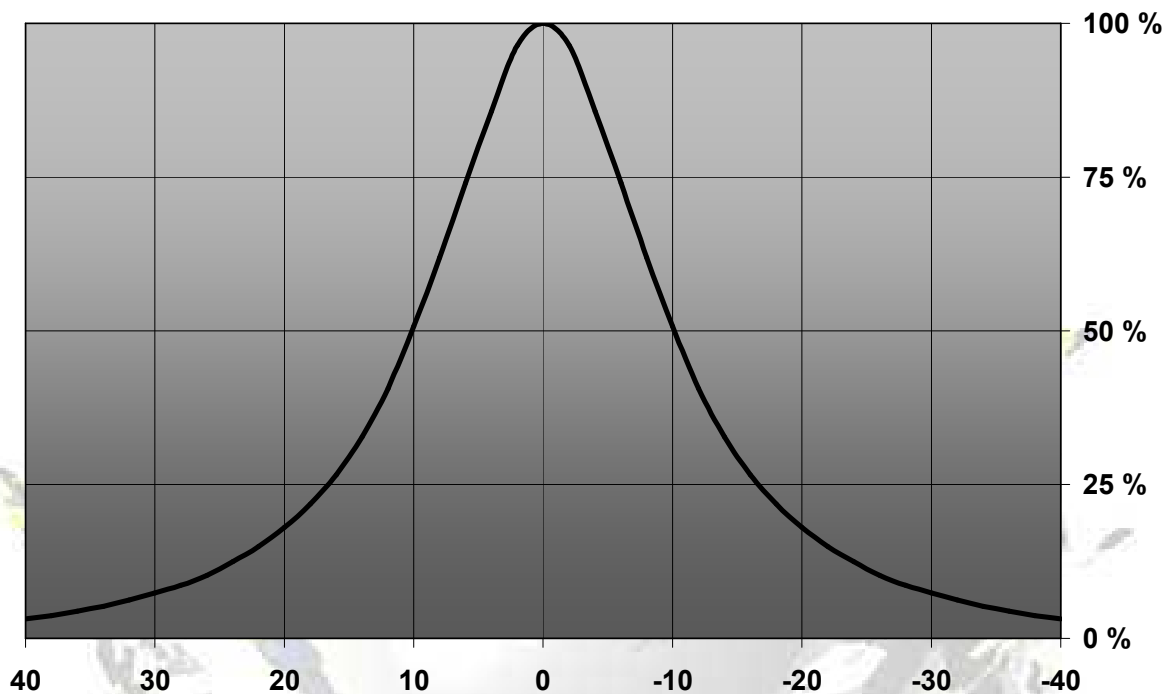

© Ledil Oy – PRELIMINARY - Subject to change without prior notice

Relative Intensity of C10633_MX6-7-MD

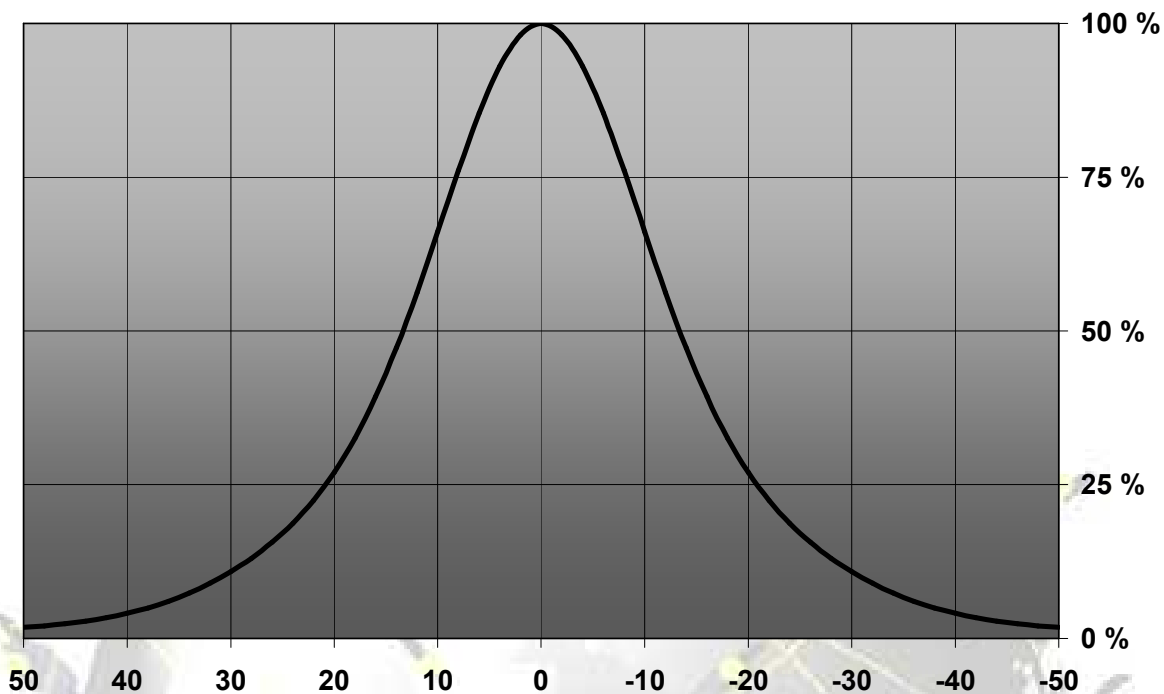

© Ledil Oy – PRELIMINARY - Subject to change without prior notice

Relative Intensity of C10585_MX6-7-W

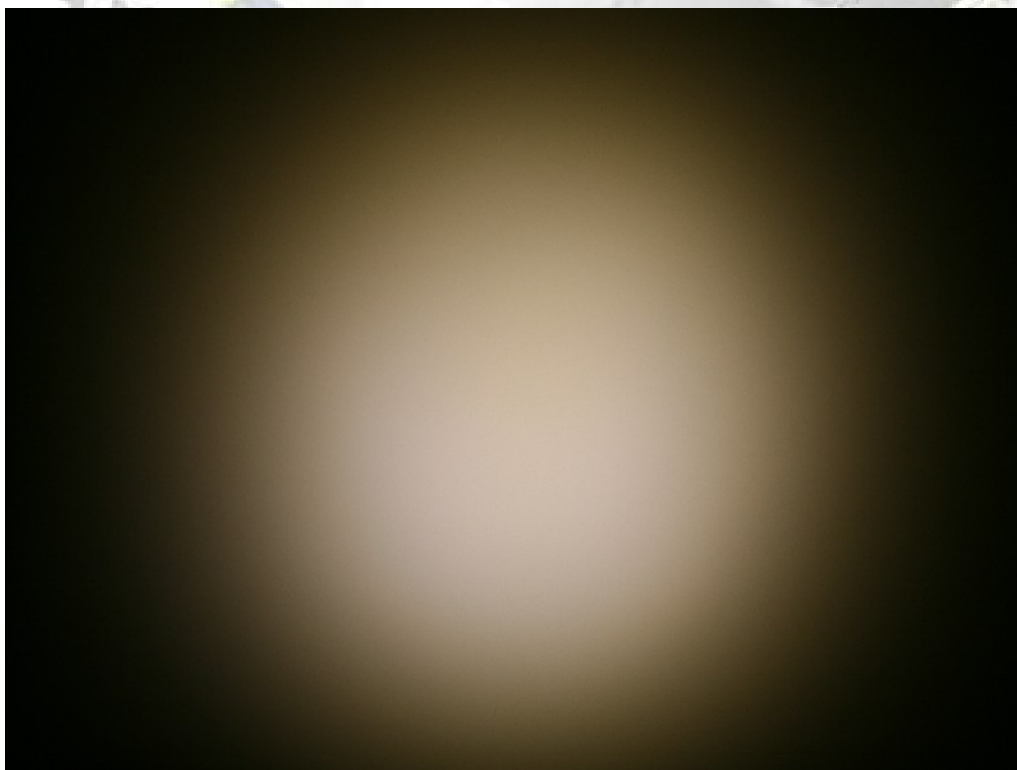
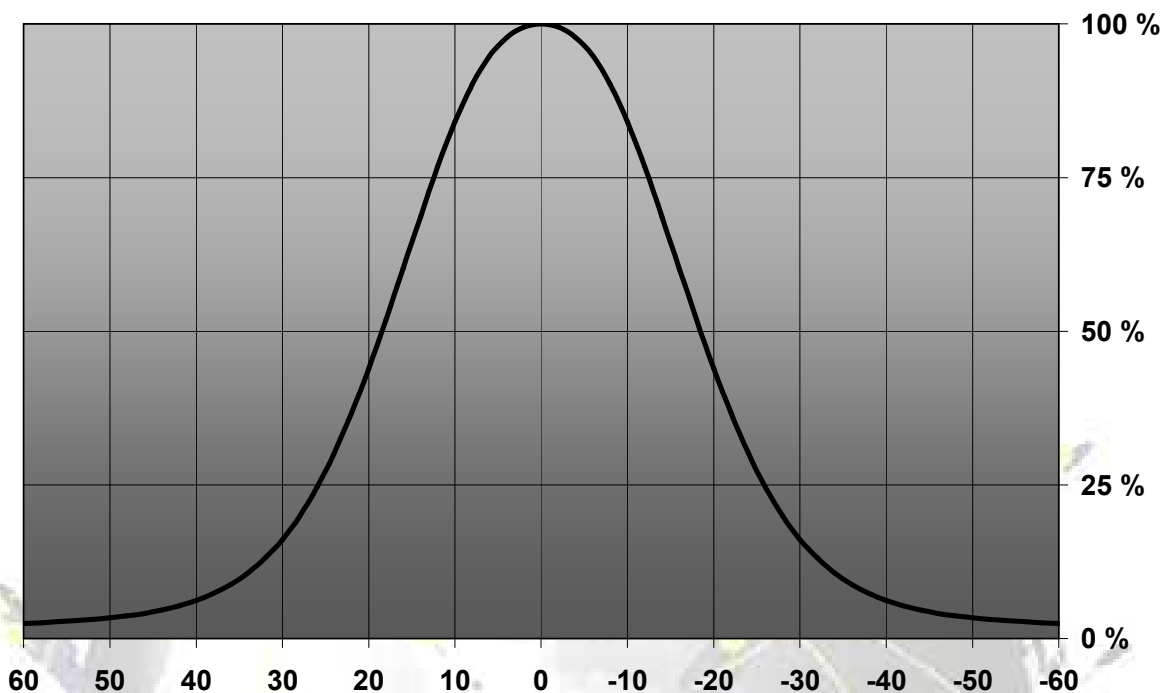

© Ledil Oy – PRELIMINARY - Subject to change without prior notice

Relative Intensity of C10586_MX6-7-WW

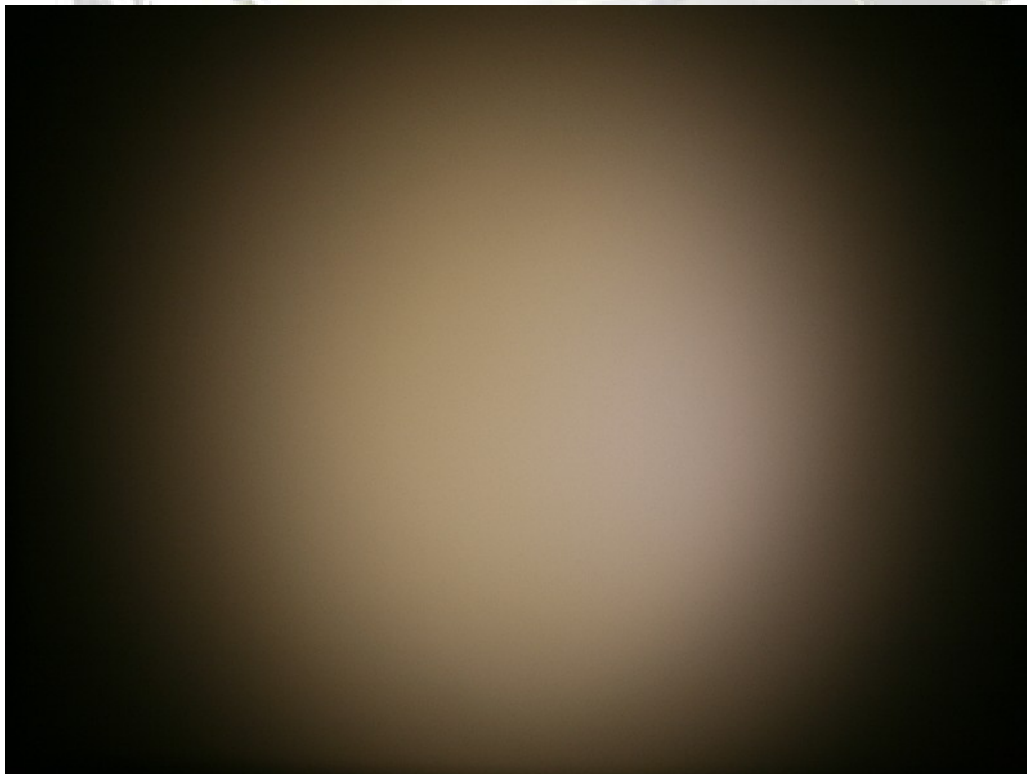
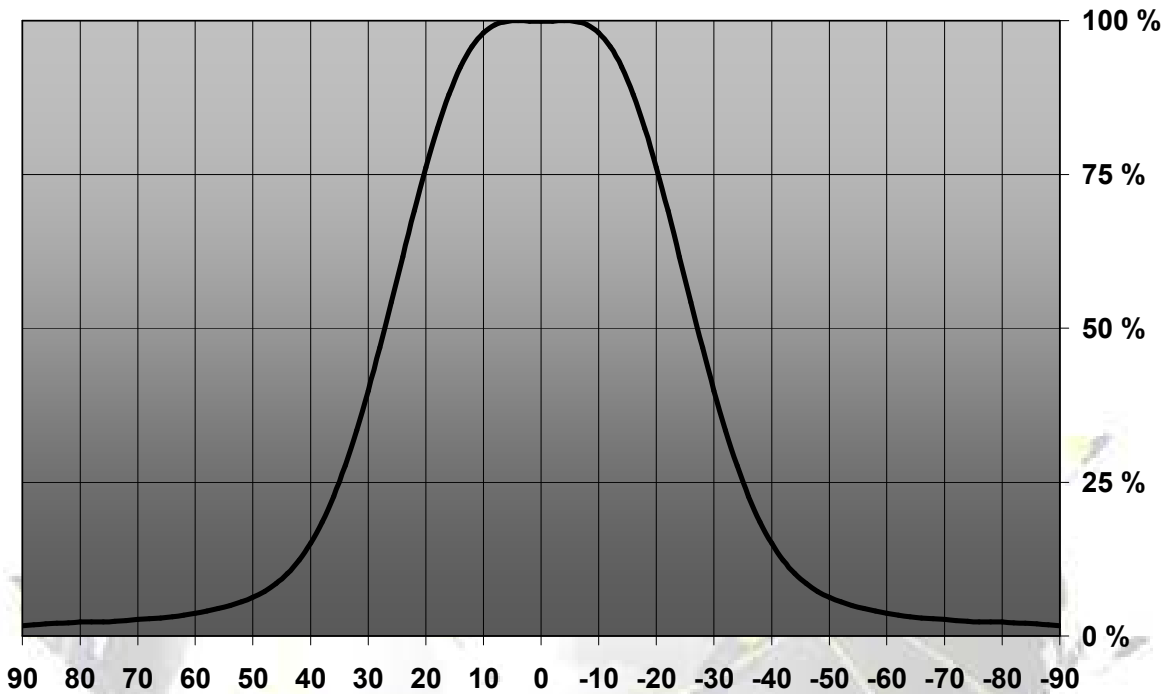

© Ledil Oy – PRELIMINARY - Subject to change without prior notice

DRAWING

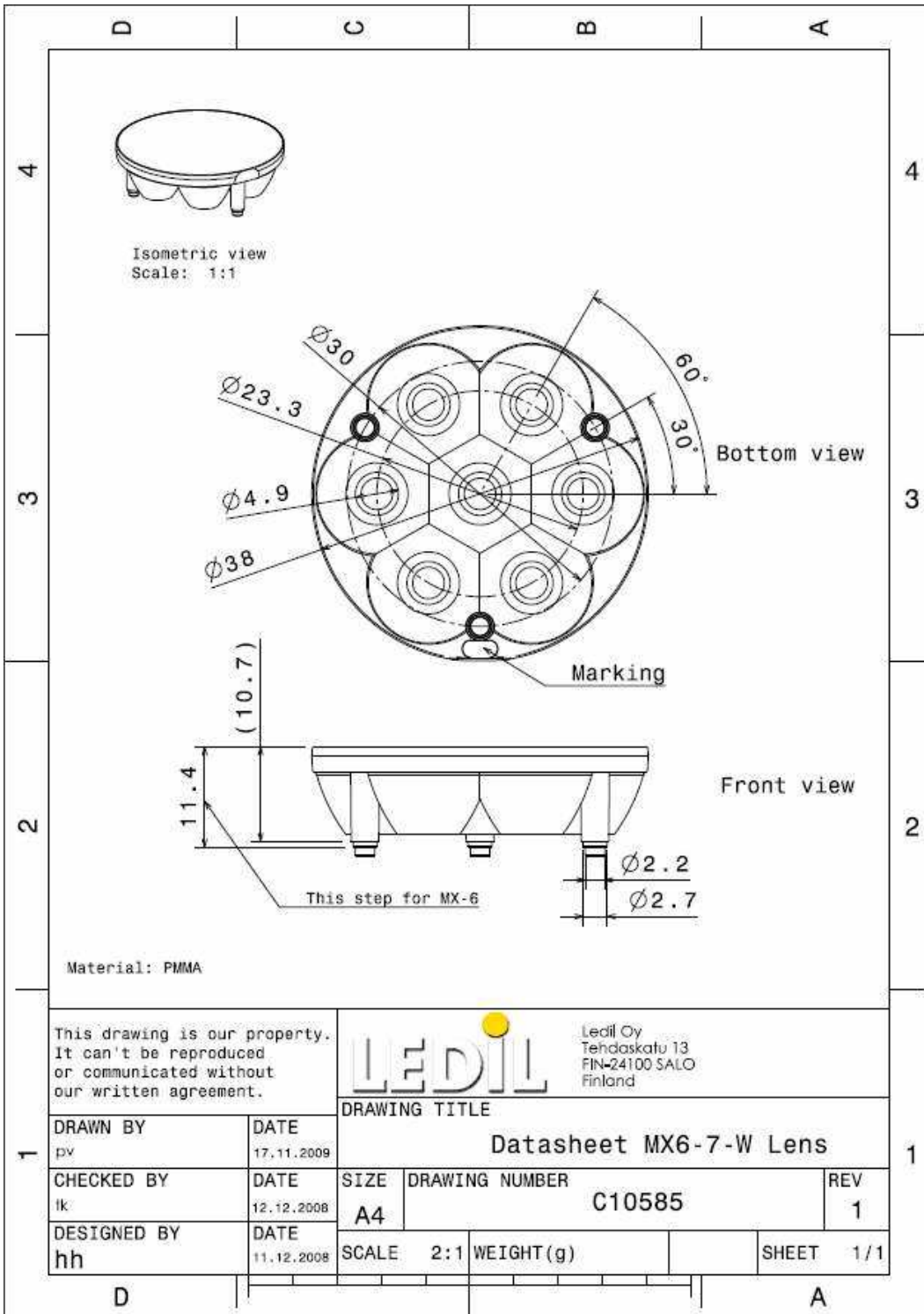

© Ledil Oy – PRELIMINARY - Subject to change without prior notice