

DESCRIPTION: QUICK RELEASE - DIE CAST

SPECIFICATION:
MATERIAL: ZINC ALLOY, ZAMAK Z0410

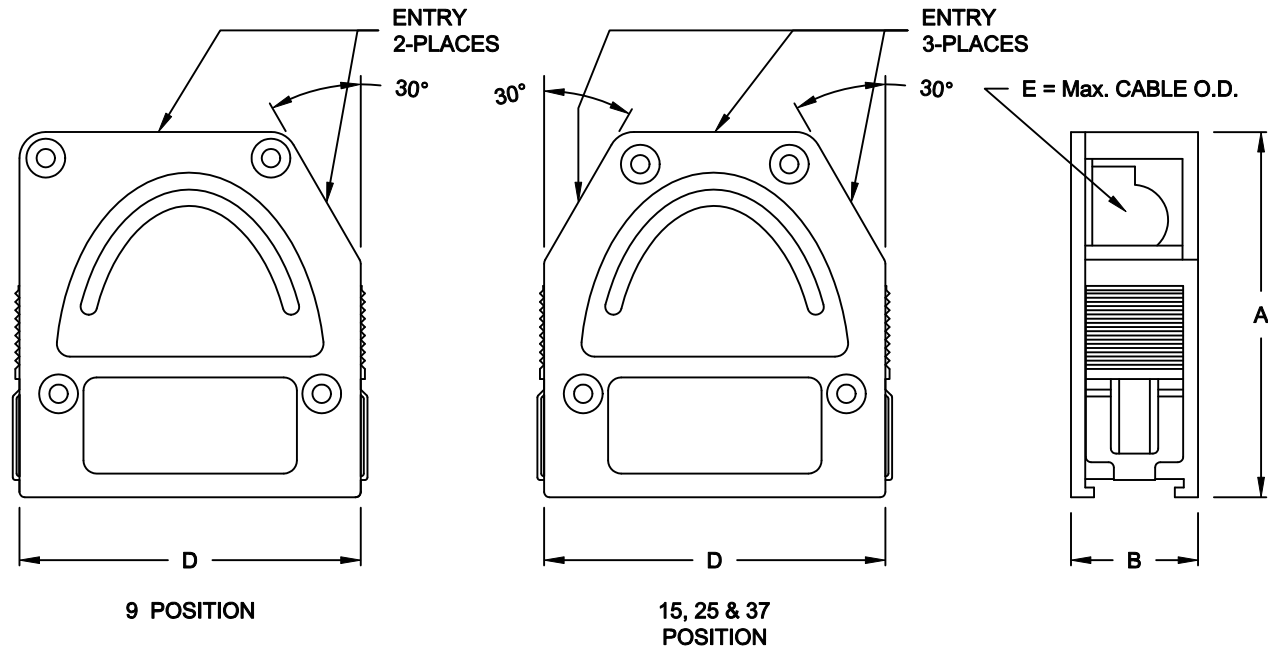

BACKSHELL KIT INCLUDES:

- (2) BACKSHELL HALVES
- (4) MOUNTING SCREWS
- (1) GROUNDING SCREW

 *** CABLE CLAMP ORDERED SEPARATELY ***
 *** SEE SHEET 2 ***

955-YYY-030R121

SERIES _____

POSITIONS _____

009 _____

015 _____

025 _____

037 _____

MATERIAL _____

030 = DIE CAST _____

RoHS COMPLIANT _____

R = HIGH TEMP. PROCESS _____

COLOR _____

12 = METAL(IZED) _____

PUT-UP _____

1 = KIT _____

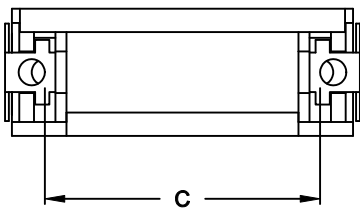

DIMENSIONS (IN.)					
No. OF PINS	A	B	C	D	E
09	1.740	0.606	0.984	1.299	0.354
15	1.740	0.606	1.312	1.626	0.394
25	1.740	0.606	1.852	2.165	0.433
37	1.740	0.606	2.500	2.815	0.433

DO NOT SCALE FROM DRAWING

	THESE DRAWINGS AND SPECIFICATIONS ARE THE PROPERTY OF NorComp AND SHALL NOT BE REPRODUCED, COPIED OR USED AS THE BASIS FOR THE MANUFACTURE OF SALE OF APPARATUS WITHOUT WRITTEN PERMISSION.		DRAWN: C. SMITH	DATE: 04-10-07
			CHECKED:	DATE:
NorComp	SCALE: 1:1	SHEET 1 OF 2	REV 1	
	DWG NO. 955-YYY-030R121			

RoHS COMPLIANT

CABLE CLAMPS ORDERED SEPARATELY

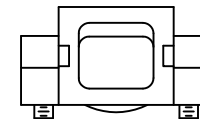
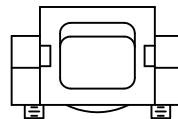
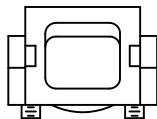
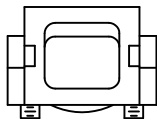
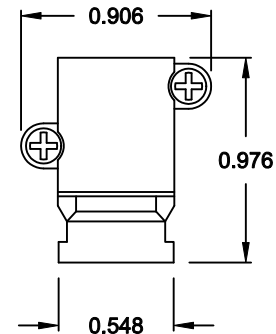
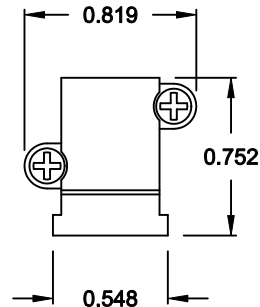
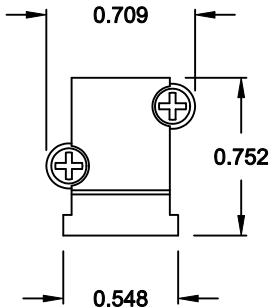
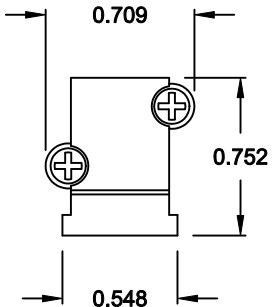
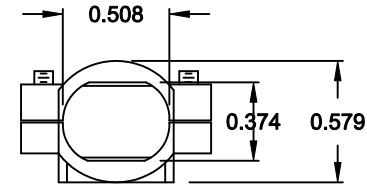
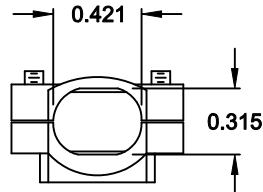
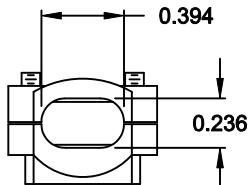
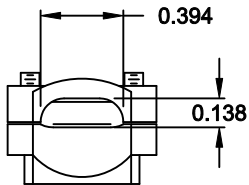

P/N 955-09-SR-4-7
CABLE RANGE = 0.157 - 0.276

P/N 955-15-SR-7-10
CABLE RANGE = 0.276 - 0.394

P/N 955-25-SR-9-12
CABLE RANGE = 0.354 - 0.472

P/N 955-37-SR-11-14
CABLE RANGE = 0.433 - 0.551

DO NOT SCALE FROM DRAWING



THESE DRAWINGS AND SPECIFICATIONS ARE THE PROPERTY OF NorComp AND SHALL NOT BE REPRODUCED, COPIED OR USED AS THE BASIS FOR THE MANUFACTURE OF SALE OF APPARATUS WITHOUT WRITTEN PERMISSION.

DRAWN: C. SMITH		DATE: 04-10-07	
CHECKED:		DATE:	
SCALE: 1:1	SHEET 2	OF 2	REV 1
DWG NO. 955-YYY-030R121			

RoHS COMPLIANT

NorComp