

DESCRIPTION: MALE - 0.283 RIGHT ANGLE / MACHINED - ECONOMY

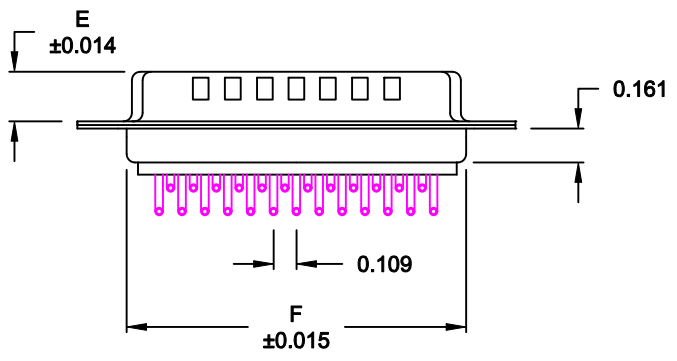
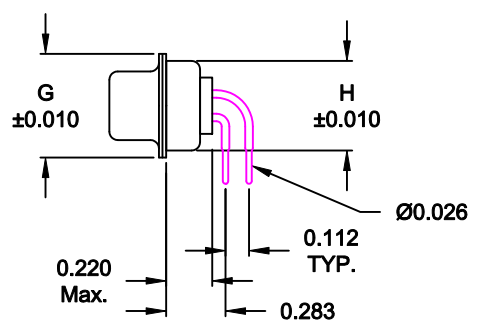
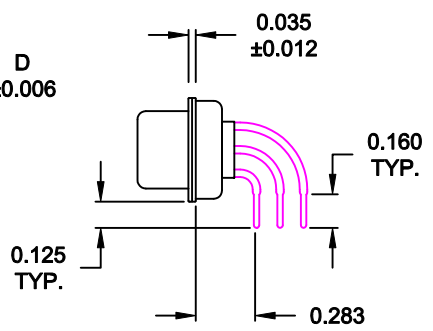
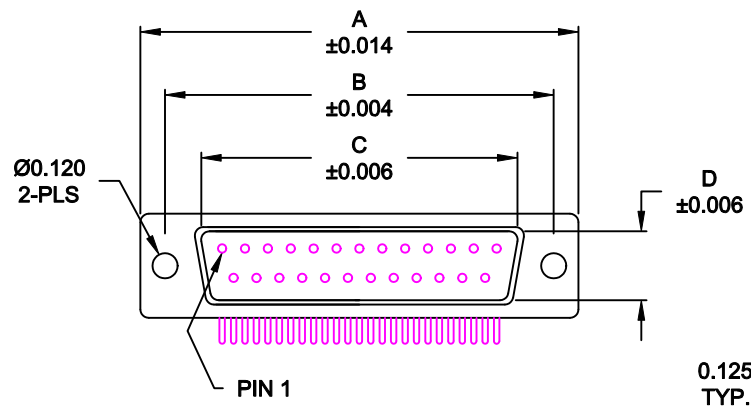

No. OF PINS	DIMENSIONS							
	A	B	C	D	E	F	G	H
9	1.213	0.984	0.666	0.329	0.236	0.756	0.496	0.427
	30.80	24.99	16.92	8.36	5.99	19.20	12.60	10.85
15	1.541	1.312	0.994	0.329	0.236	1.091	0.496	0.427
	39.15	33.32	25.25	8.36	5.99	27.70	12.60	10.85
25	2.087	1.852	1.534	0.329	0.236	1.618	0.496	0.427
	53.00	47.04	38.96	8.36	5.99	41.10	12.60	10.85
37	2.728	2.500	2.182	0.329	0.236	2.256	0.496	0.427
	69.30	63.50	55.42	8.36	5.99	57.30	12.60	10.85
50	2.638	2.406	2.079	0.436	0.240	2.169	0.602	0.527
	67.00	61.11	52.80	11.07	6.10	55.10	15.30	13.39

173-EYY-11YRYY1

- SERIES \_\_\_\_\_
- POSITIONS \_\_\_\_\_
- E09 \_\_\_\_\_
- E15 \_\_\_\_\_
- E25 \_\_\_\_\_
- E37 \_\_\_\_\_
- E50 \_\_\_\_\_
- GENDER \_\_\_\_\_
- 1 = MALE \_\_\_\_\_
- TERMINATION \_\_\_\_\_
- 1 = PC MOUNTING \_\_\_\_\_
- SHELL PLATING \_\_\_\_\_
- 3 = NICKEL (GROUND INDENTS) \_\_\_\_\_
- RoHS COMPLIANT \_\_\_\_\_
- HARDWARE OPTIONS \_\_\_\_\_
- 00 = NO HARDWARE \_\_\_\_\_
- 14 = SHORT BRACKET WITH 4-40 SCREW LOCK \_\_\_\_\_
- 24 = SHORT BRACKET WITH 4-40 SCREW \_\_\_\_\_
- 46 = BRACKET WITH 4-40 INSERT & BOARDLOCK \_\_\_\_\_
- PLATING OPTIONS \_\_\_\_\_
- 1 = GOLD FLASH \_\_\_\_\_
- 2 = 30MICRO-INCH GOLD \_\_\_\_\_
- 3 = 50MICRO-INCH GOLD \_\_\_\_\_

**MATERIAL:**

- SHELL: STEEL, NICKEL PLATED
- INSULATOR: UL 94V-O RATED, WHITE PA6T
- PROCESS TEMP.: 260° PROCESS TEMPERATURE
- CONTACT: BRASS

**ELECTRICAL:**

- CURRENT RATING: 5 AMPS
- CONTACT RESISTANCE: 15 mOhms Max.
- INSULATION RESISTANCE: 1,000 MOhms min.
- VOLTAGE: 500VAC FOR 1 MINUTE
- TEMPERATURE: -50° C TO 100° C

DO NOT SCALE FROM DRAWING

RoHS COMPLIANT

	THESE DRAWINGS AND SPECIFICATIONS ARE THE PROPERTY OF NorComp AND SHALL NOT BE REPRODUCED, COPIED OR USED AS THE BASIS FOR THE MANUFACTURE OF SALE OF APPARATUS WITHOUT WRITTEN PERMISSION.		DRAWN: <b>WAYNE ROBBINS</b>	DATE: <b>09-01-98</b>
			CHECKED:	DATE:
<h1>NorComp</h1>		SCALE: <b>1:1</b>	SHEET <b>1</b> OF <b>3</b>	REV <b>8</b>
		DWG NO. <b>173-EYY-11YRYY1</b>		

DESCRIPTION: PCB LAYOUT - STANDARD "D" - MALE & FEMALE

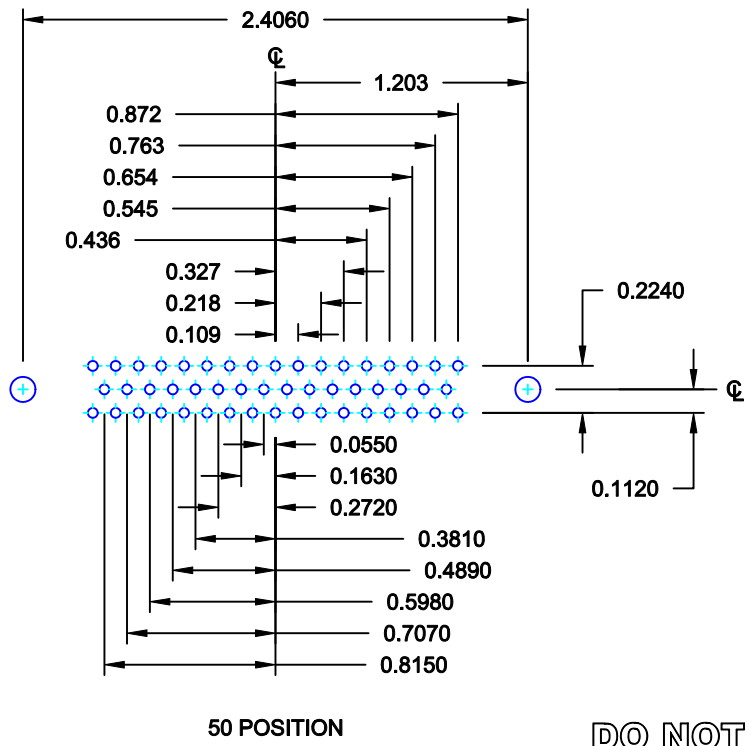
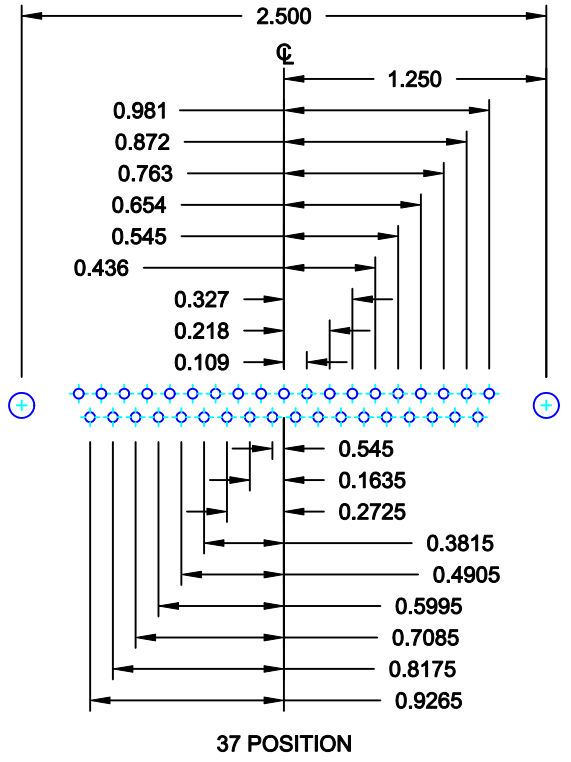
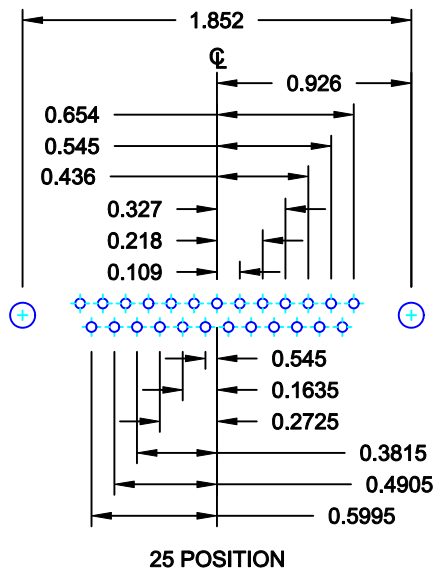
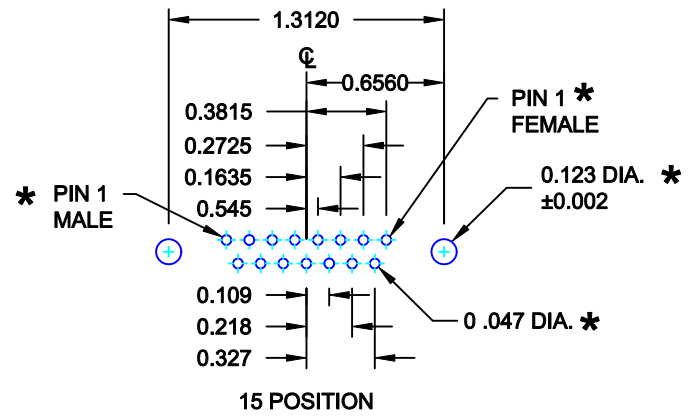
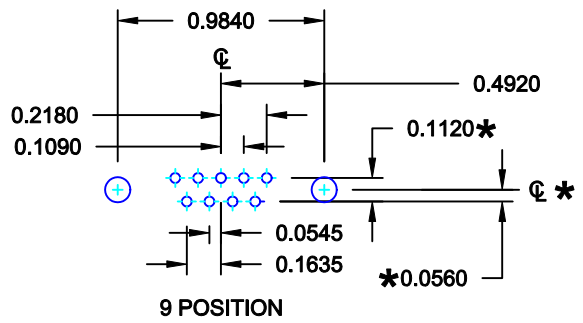

\* TYP. ON ALL SIZES

DO NOT SCALE FROM DRAWING

	THESE DRAWINGS AND SPECIFICATIONS ARE THE PROPERTY OF NorComp AND SHALL NOT BE REPRODUCED, COPIED OR USED AS THE BASIS FOR THE MANUFACTURE OF SALE OF APPARATUS WITHOUT WRITTEN PERMISSION.		DRAWN: <b>C. SMITH</b>	DATE: <b>03-08-06</b>
			CHECKED:	DATE:
<b>NorComp</b>		SCALE: <b>FULL</b>	SHEET <b>2</b> OF <b>3</b>	REV <b>8</b>
		DWG NO. <b>173-EYY-11YRY1</b>		

## HARDWARE OPTIONS

REPLACE -YY IN LAST 3 DIGITS WITH OPTION CHOSEN

173/174 SERIES

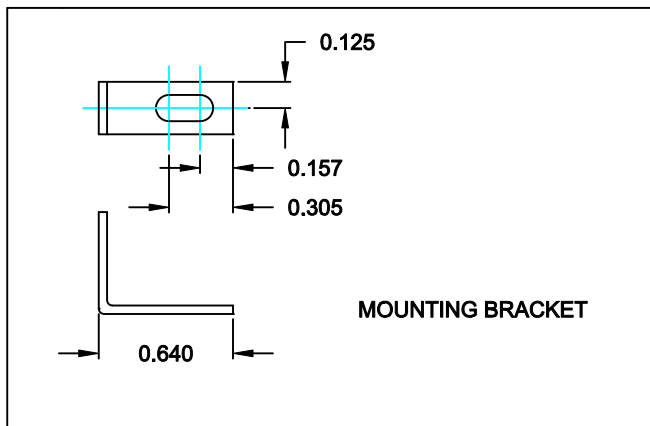

173 / 174 SERIES

14Y = SHORT BRACKET & 4-40

FEMALE HEX SOCKET

24Y = SHORT BRACKET & 4-40 SCREW

MATERIAL: COLD ROLLED STEEL

PLATING: CLEAR ZINC

46Y = BRACKET WITH 4-40 INSERT AND BOARDLOCK

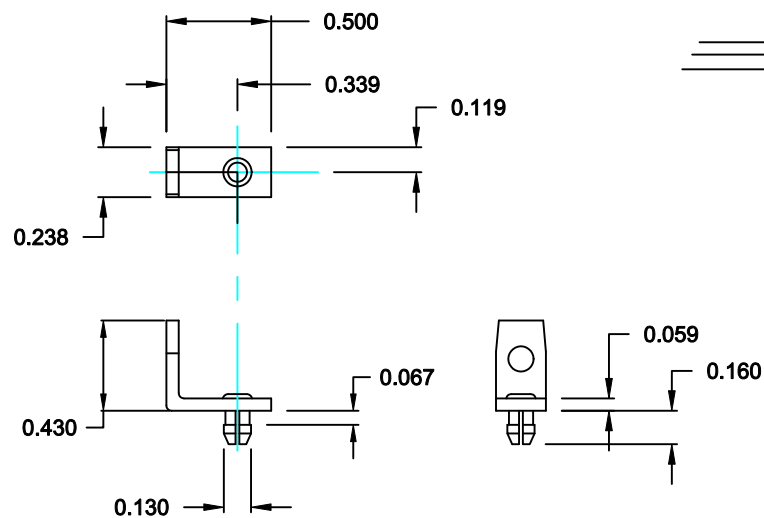

MOUNTING BRACKET  
WITH BOARD LOCK

RoHS COMPLIANT

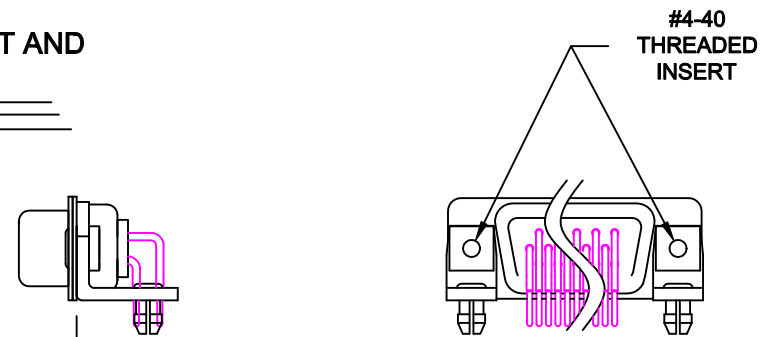

BRACKETS MOUNTED ON CONNECTOR

DO NOT SCALE FROM DRAWING

	THESE DRAWINGS AND SPECIFICATIONS ARE THE PROPERTY OF NorComp AND SHALL NOT BE REPRODUCED, COPIED OR USED AS THE BASIS FOR THE MANUFACTURE OF SALE OF APPARATUS WITHOUT WRITTEN PERMISSION.		DRAWN: <b>PAM JENKINS</b>	DATE: <b>11-28-05</b>
			CHECKED:	DATE:
NorComp		SCALE:	SHEET <b>3</b> OF <b>3</b>	REV <b>8</b>
		DWG NO. <b>173-EYY-11YRY1</b>		