

DESCRIPTION: HIGH DENSITY - FEMALE - RIGHT ANGLE

44 PIN SHOWN

DIMENSIONS (IN.)							
No. OF PINS	A	B	C	D	E	F	G
15	1.213	0.984	0.644	0.090	0.311	0.496	0.639
	30.80	24.99	16.34	2.29	7.90	12.60	16.23
26	1.543	1.312	0.966	0.090	0.311	0.496	0.639
	39.19	33.32	24.53	2.29	7.90	12.60	16.23
44	2.087	1.852	1.512	0.090	0.311	0.496	0.639
	53.00	47.04	38.40	2.29	7.90	12.60	16.23
62	2.732	2.500	2.156	0.095	0.311	0.496	0.639
	69.30	63.50	54.76	2.41	7.90	12.60	16.23

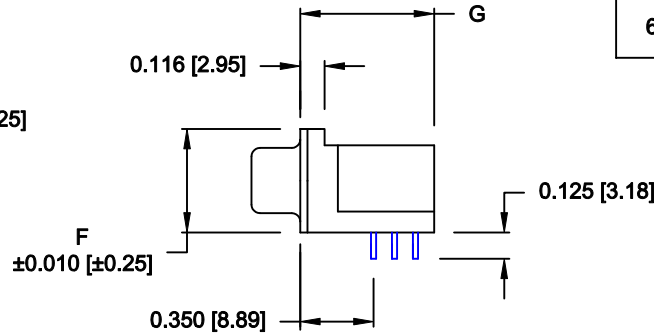
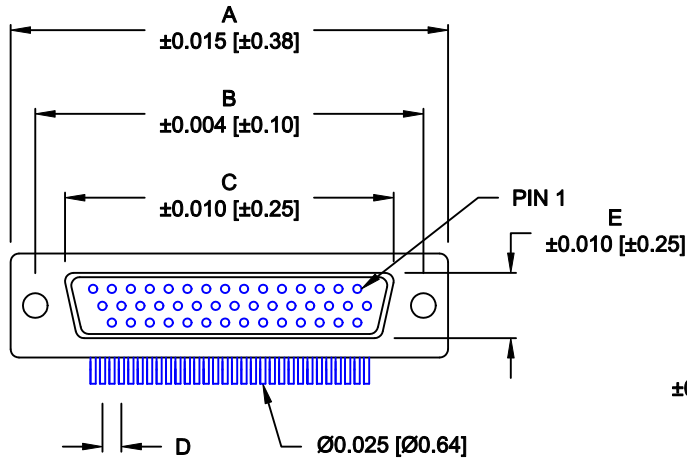

**181-YYY-2 1 3 R YY 1**

SERIES \_\_\_\_\_  
 POSITIONS \_\_\_\_\_  
 015 \_\_\_\_\_  
 026 \_\_\_\_\_  
 044 \_\_\_\_\_  
 062 \_\_\_\_\_  
 GENDER \_\_\_\_\_  
 2 = FEMALE \_\_\_\_\_  
 TERMINATION \_\_\_\_\_  
 1 = DIP SOLDER \_\_\_\_\_  
 SHELL PLATING \_\_\_\_\_  
 3 = NICKEL PLATED \_\_\_\_\_  
 RoHS COMPLIANT \_\_\_\_\_  
 (HIGH TEMP. PROCESS) \_\_\_\_\_  
 HARDWARE OPTIONS \_\_\_\_\_  
 16 =  $\emptyset$  0.120 HOLE / INSIDE GND STRAPS \_\_\_\_\_  
 17 = 4-40 INSERTS / INSIDE GND STRAPS \_\_\_\_\_  
 18 = 4-40 SCREWLOCKS / INSIDE GND STRAPS \_\_\_\_\_  
 43 =  $\emptyset$  0.120 HOLE / METAL SHELL \_\_\_\_\_  
 45 = 4-40 INSERTS / METAL SHELL \_\_\_\_\_  
 48 = 4-40 SCREWLOCKS / METAL SHELL \_\_\_\_\_  
 53 = 4-40 INSERTS / BOARDLOCKS \_\_\_\_\_  
 55 =  $\emptyset$  0.120 HOLE / BOARDLOCKS \_\_\_\_\_  
 56 = 4-40 SCREWLOCKS / BOARDLOCKS \_\_\_\_\_  
 PLATING OPTIONS \_\_\_\_\_  
 1 = GOLD FLASH \_\_\_\_\_

**ELECTRICAL:**

CURRENT RATING: 2 AMPS  
 CONTACT RESISTANCE: 15 MILLIOhms Max.  
 INSULATION RESISTANCE: 1,000 MEGOhms Min.  
 VOLTAGE: 500V FOR 1 MINUTE  
 TEMPERATURE: -50°C TO +100°C

**MATERIALS:**

SHELL: SPCC, NICKEL PLATED  
 INSULATOR: PA9T-BLACK (UL94-0)  
 260°C PROCESS TEMPERATURE  
 CONTACT: BRASS, GOLD ENTIRE CONTACT  
 RIVET: COPPER ALLOY, NICKEL PLATED  
 BOARDLOCK: SPCC, TIN PLATED  
 SCREWLOCK: ZINC ALLOY, NICKEL PLATED

DO NOT SCALE FROM DRAWING



THESE DRAWINGS AND SPECIFICATIONS ARE THE PROPERTY OF NorComp AND SHALL NOT BE REPRODUCED, COPIED OR USED AS THE BASIS FOR THE MANUFACTURE OR SALE OF APPARATUS WITHOUT WRITTEN PERMISSION.

DRAWN: PAM JENKINS		DATE: 3-15-05	
CHECKED:		DATE:	
SCALE:	SHEET 1 OF 3	REV 12	
DWG NO. 181-YYY-213RYY1			

RoHS COMPLIANT

NorComp

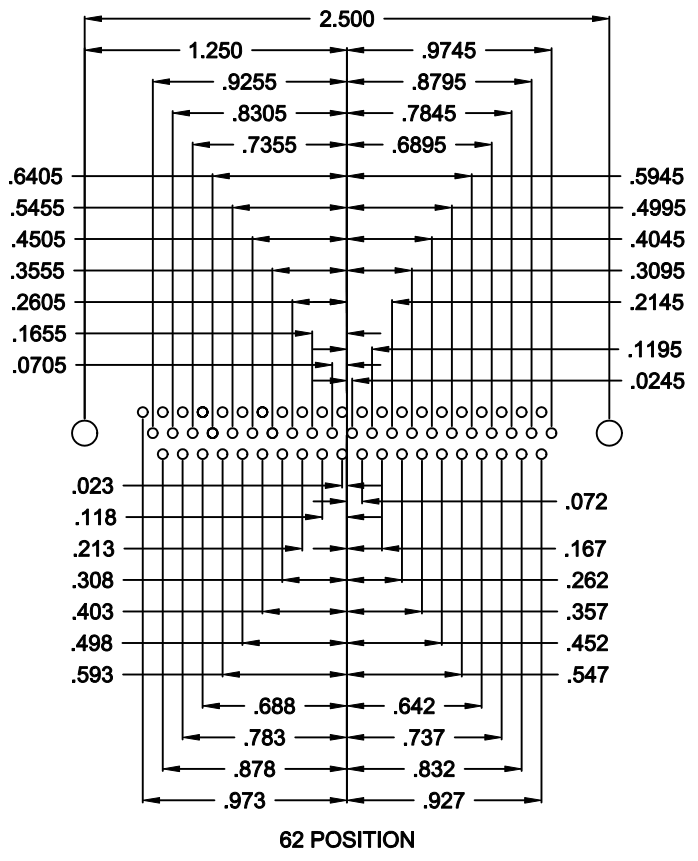
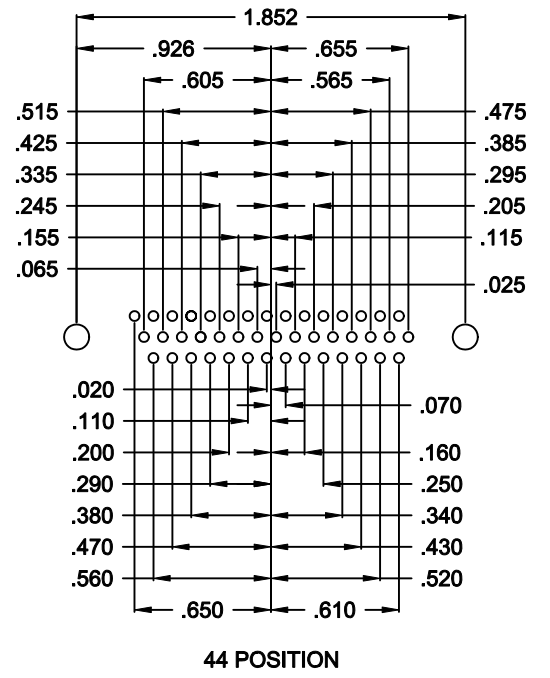
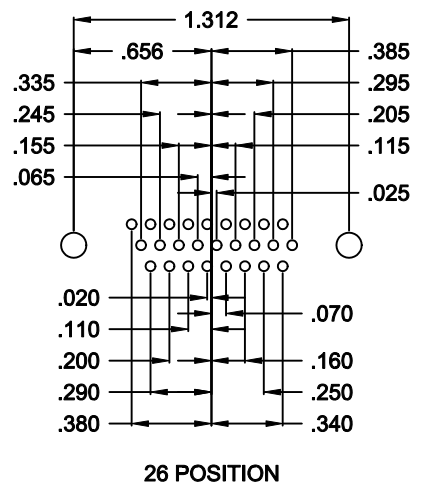
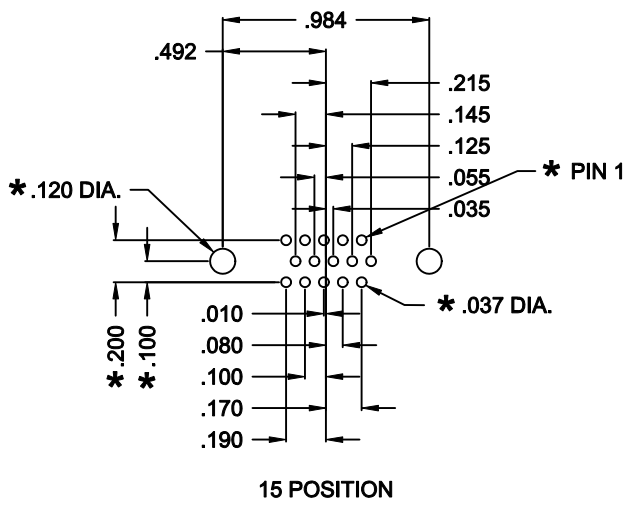

**181 SERIES  
HIGH DENSITY  
RIGHT ANGLE**

**HOLE PATTERN SHOWN  
ARE FOR FEMALE**

**\* TYP. ON ALL SIZES**

**DO NOT SCALE FROM DRAWING**

	THESE DRAWINGS AND SPECIFICATIONS ARE THE PROPERTY OF NorComp AND SHALL NOT BE REPRODUCED, COPIED OR USED AS THE BASIS FOR THE MANUFACTURE OR SALE OF APPARATUS WITHOUT WRITTEN PERMISSION.		DRAWN: <b>C. SMITH</b>	DATE: <b>03-09-06</b>	
			CHECKED:	DATE:	
<h1>NorComp</h1>			SCALE: <b>FULL</b>	SHEET <b>2</b> OF <b>3</b>	REV <b>12</b>
			DWG NO. <b>181-YYY-213RYY1</b>		

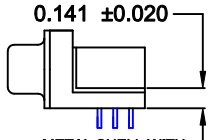
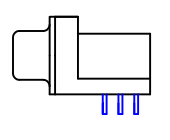
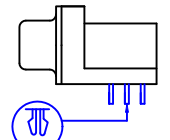
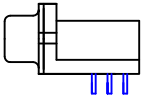
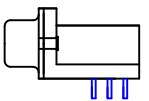
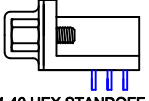
	 <p>0.141 ±0.020</p> <p>METAL SHELL WITH INSIDE GROUND STRAPS</p>	 <p>METAL SHELL</p>	 <p>METAL SHELL FORK BOARD LOCKS</p>
 <p>.120" DIA. HOLE</p>	16	43	55
 <p>4-40 FLUSH INSERT</p>	17	45	53 BOARD LOCKS
 <p>4-40 HEX STANDOFF FEMALE SCREWLOCK</p>	18	48	56 BOARD LOCKS

RoHS COMPLIANT

	THESE DRAWINGS AND SPECIFICATIONS ARE THE PROPERTY OF NorComp AND SHALL NOT BE REPRODUCED, COPIED OR USED AS THE BASIS FOR THE MANUFACTURE OR SALE OF APPARATUS WITHOUT WRITTEN PERMISSION.		DRAWN: <b>WAYNE ROBBINS</b>	DATE: <b>3-17-05</b>
			CHECKED:	DATE:
<h1>NorComp</h1>		SCALE:	SHEET <b>3</b> OF <b>3</b>	REV <b>12</b>
		DWG NO. <b>181-YYY-213RYY1</b>		