

DESCRIPTION: POWER - SOLDER CUP - FEMALE

SPECIFICATIONS:

ELECTRICAL:
 INSULATOR RESISTANCE: 5,000 MegOHMS Min.
 DIELECTRIC WITHSTANDING: 1,000VAC r.m.s.
 OPERATING TEMPERATURE: -55° C ~ +125° C
 CONTACT RESISTANCE: 30 MillioHMS Max.
 POWER PINS: SEE PART No. BELOW

MECHANICAL:
 CONTACT INSERTION FORCE: 4.5 Kg Max.
 CONTACT SEPARATOR FORCE: 0.3Kg Min.

MATERIALS:
 CONTACTS: BRASS
 INSULATOR: PBT UL94V-0 RATED,
 230°C PROCESS TEMP.
 SHELL: STEEL

FINISH:
 SHELL: NICKEL

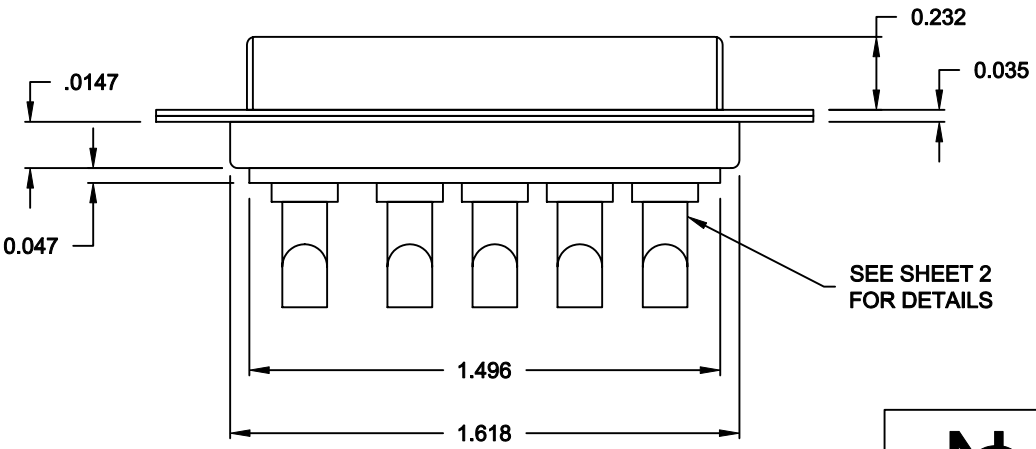
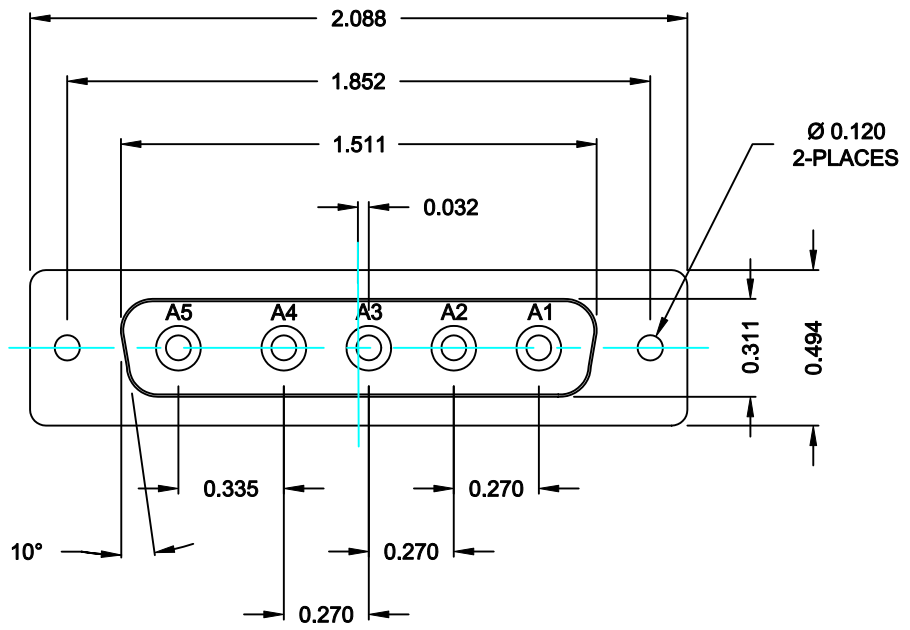

6805W5203LYY1

20 = 20 AMPS
 40 = 40 AMPS

RoHS COMPLIANT

	THESE DRAWINGS AND SPECIFICATIONS ARE THE PROPERTY OF NorComp AND SHALL NOT BE REPRODUCED, COPIED OR USED AS THE BASIS FOR THE MANUFACTURE OF SALE OF APPARATUS WITHOUT WRITTEN PERMISSION.		DRAWN: C. SMITH	DATE: 09-11-06
			CHECKED: X	DATE: X
NorComp	SCALE: N.T.S.	SHEET 1	OF 2	REV 0
	DWG NO. 6805W5203LYY1			

DESCRIPTION: 680 SERIES CONTACTS

NOTE:
POWER CONTACTS COME
PRE-LOADED INTO INSULATORS

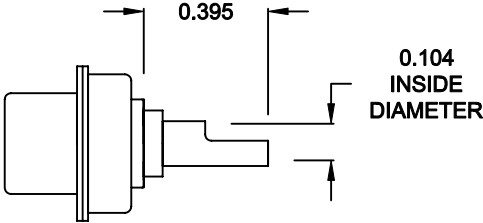

20 AMP POWER CONTACTS
ACCEPTS UP TO 12 AWG WIRE

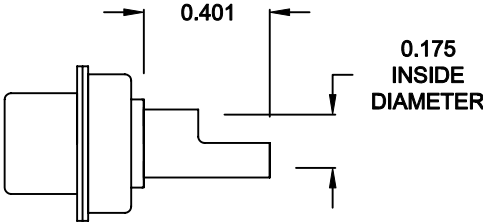

40 AMP POWER CONTACTS
ACCEPTS UP TO 8 AWG WIRE

RoHS COMPLIANT

	THESE DRAWINGS AND SPECIFICATIONS ARE THE PROPERTY OF NorComp AND SHALL NOT BE REPRODUCED, COPIED OR USED AS THE BASIS FOR THE MANUFACTURE OF SALE OF APPARATUS WITHOUT WRITTEN PERMISSION.	DRAWN: C. SMITH	DATE: 09-11-06
		CHECKED: X	DATE: X
<h1>NorComp</h1>	SCALE: N.T.S.	SHEET 2 OF 2	REV 0
	DWG NO. 6805W5203LYY1		