

SPECIFICATIONS:

ELECTRICAL:

INSULATOR RESISTANCE:	5,000 MegOHMS Min.
DIELECTRIC WITHSTANDING:	1,000VAC r.m.s.
OPERATING TEMPERATURE:	-55° C ~ +125° C
CONTACT RESISTANCE:	30 MilliOHMS Max.
COAXIAL PINS:	50 OHM
SIGNAL PINS:	3 AMPS

MECHANICAL:

CONTACT INSERTION FORCE:	4.5 Kg Max.
CONTACT SEPARATOR FORCE:	0.3Kg Min.

MATERIALS:

CONTACTS:	BRASS
INSULATOR:	PBT UL94V-0 RATED, 230°C PROCESS TEMP.
SHELL:	STEEL
FINISH:	
SHELL:	NICKEL

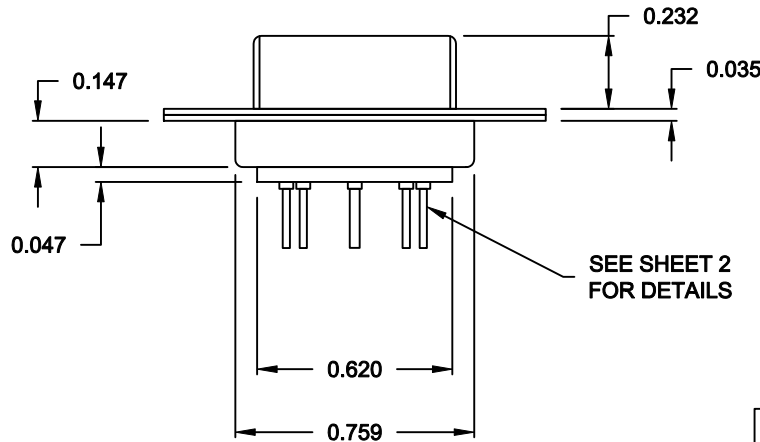
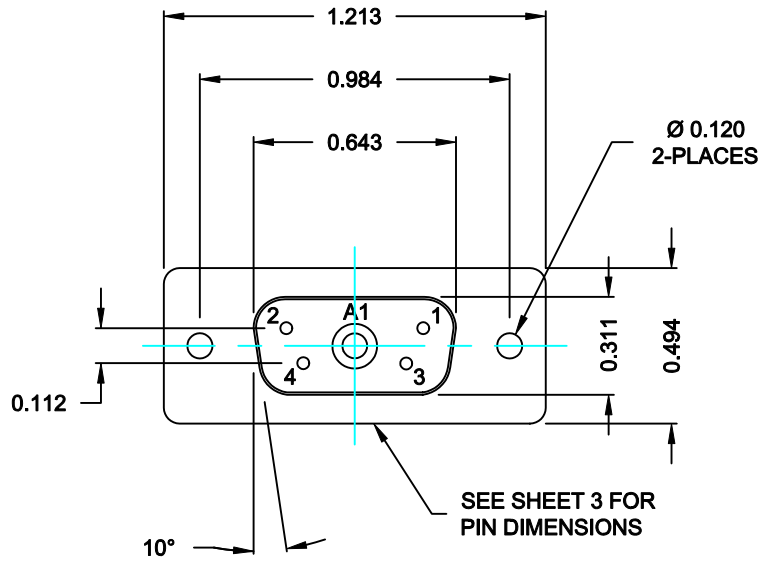

6835W1203L001

00 = 50 OHM COAXIAL

RoHS COMPLIANT

	THESE DRAWINGS AND SPECIFICATIONS ARE THE PROPERTY OF NorComp AND SHALL NOT BE REPRODUCED, COPIED OR USED AS THE BASIS FOR THE MANUFACTURE OF SALE OF APPARATUS WITHOUT WRITTEN PERMISSION.		DRAWN: C. SMITH	DATE: 09-22-06
			CHECKED: X	DATE: X
NorComp	SCALE: N.T.S.	SHEET 1	OF 2	REV 1
	DWG NO. 6835W1203L001			

**NOTE:
SIGNAL AND COAXIAL CONTACTS
COME PRE-LOADED INTO INSULATORS**

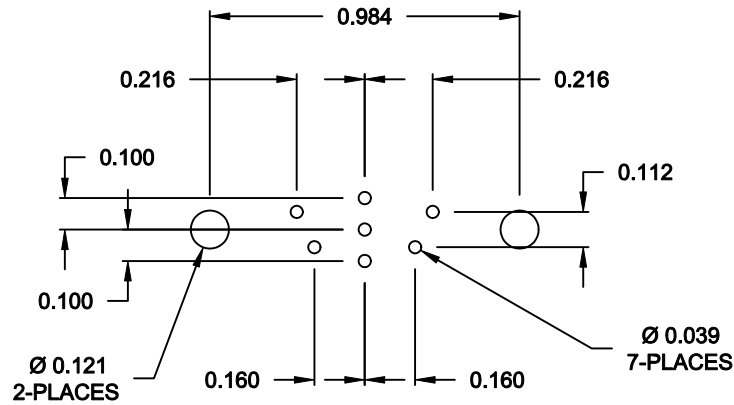

RECOMMENDED PCB LAYOUT

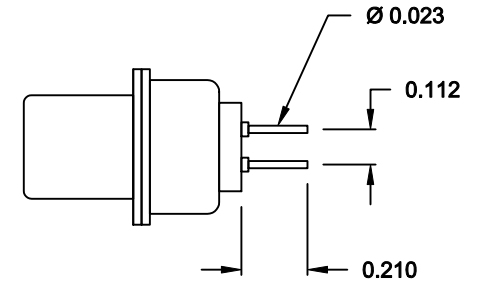

SIGNAL CONTACTS

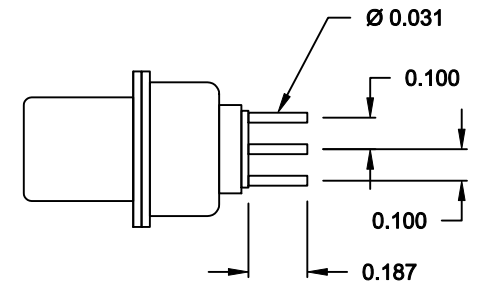

50 OHM COAXIAL CONTACT

RoHS COMPLIANT

	THESE DRAWINGS AND SPECIFICATIONS ARE THE PROPERTY OF NorComp AND SHALL NOT BE REPRODUCED, COPIED OR USED AS THE BASIS FOR THE MANUFACTURE OF SALE OF APPARATUS WITHOUT WRITTEN PERMISSION.	DRAWN: C. SMITH	DATE: 09-22-06
		CHECKED: X	DATE: X
NorComp	SCALE: N.T.S.	SHEET 2 OF 2	REV 1
	DWG NO. 6835W1203L001		