

General Specifications

Electrical Capacity (Resistive Load)

Logic Level: 0.4VA maximum @ 28V AC/DC maximum
(Applicable Range 0.1mA ~ 0.1A @ 20mV ~ 28V)
Note: Find additional explanation of operating range in Supplement section.

Other Ratings

Contact Resistance: 50 milliohms maximum
Insulation Resistance: 500 megohms minimum @ 500V DC
Dielectric Strength: 500V AC minimum for 1 minute minimum
Mechanical Life: 50,000 operations minimum
Electrical Life: 50,000 operations minimum
Nominal Operating Force: 2.55N
Contact Timing: Nonshorting (break-before-make)
Travel: Pretravel: .082" (2.1mm); Overtravel: .016" (0.4mm); Total Travel: .098" (2.5mm)

Materials & Finishes

Actuator: Glass fiber reinforced polyamide
Upper Case Housing: Carbon blended polyacetal (antistatic)
Lower Case Housing: Glass fiber reinforced polyamide
Support Bracket: Tin plated phosphor bronze
Movable Contact: Phosphor bronze with gold plating
Stationary Contacts: Brass with gold plating
Terminals: Brass with gold plating

Environmental Data

Operating Temperature Range: -30°C through +85°C (-22°F through +185°F)
Humidity: 90 ~ 95% humidity for 192 hours @ 40°C (104°F)
Vibration: 10 ~ 60Hz with peak-to-peak amplitude of 1.5mm traversing the frequency range & returning in 5 minutes; 3 right angled directions for 30 minutes
Shock: 50G (490m/s²) acceleration (tested in 6 right angled directions, with 5 shocks in each direction)

PCB Processing

Soldering: Wave Soldering Recommended. See Profile A in Supplement section.
Manual Soldering: for single pole see Profile B in Supplement section; for double pole see Profile A.
Cleaning: These devices are not process sealed. Hand clean locally using alcohol based solution.

Standards & Certifications

The A Series slides have not been tested for UL recognition or CSA certification. These switches are designed for use in a low-voltage, low-current, logic-level circuit. When used as intended in a logic-level circuit, the results do not produce hazardous energy.

Distinctive Characteristics

Subminiature size (1/3 size of Series M switches) saves space on PC boards.

Specifically developed for logic-level applications.

Award-winning STC contact mechanism with benefits unavailable in conventional mechanisms: smoother, positive detent actuation, increased contact stability and unparalleled logic-level reliability. (Additional STC details in Terms & Acronyms; see Supplement section.)

Available in various actuator lengths.

Antistatic superstructure of carbon blended polyacetal prevents static discharge to the contacts.

Molded-in, epoxy sealed or ultrasonically welded terminals lock out flux, solvents, and other contaminants.

.100" x .100" (2.54mm x 2.54mm) terminal spacing conforms to standard PC board grid spacing.

Matching indicators available.

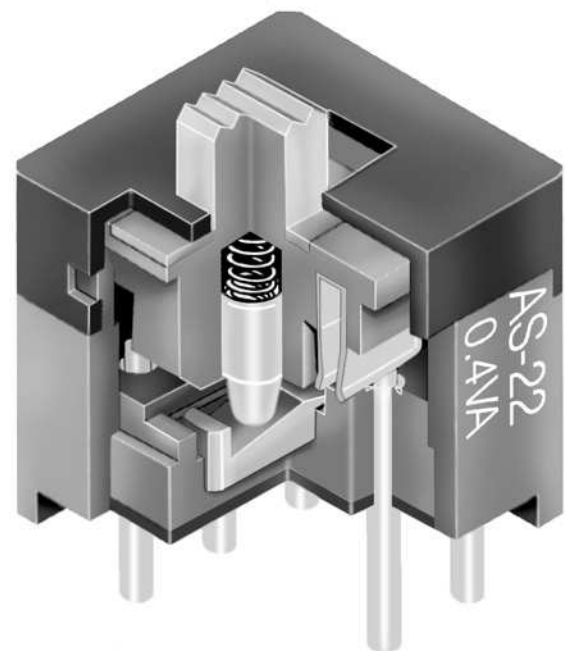

Actual Size

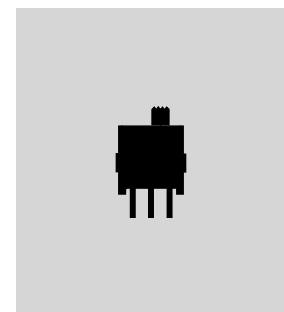

TYPICAL SWITCH ORDERING EXAMPLE

AS **2** **2** **A** **H**

Poles		Circuits				Actuators		PC Terminals	
1	SPST SPDT	1	ON	NONE	OFF	A	.098" (2.5mm) Long	P	Straight
2	DPDT SP3T	2	ON	NONE	ON	B	Flush	*B	Straight with Bracket
		3	ON	OFF	ON	C	.150" (3.8mm) Long	*H	Right Angle with Bracket
		4	ON	ON	ON			*V	Vertical with Bracket

*Bracketed models are ESD protected

DESCRIPTION FOR TYPICAL ORDERING EXAMPLE

AS22AH



DPDT
ON-NONE-ON Circuit

.098" (2.5mm) Long
Actuator

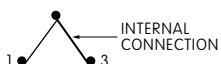

Right Angle PC Terminals

POLES & CIRCUITS

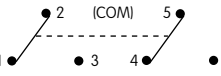
Pole	Model	Slide Position			Connected Terminals			Throw & Schematics
		Left	Center	Right	Left	Center	Right	
SP	AS11	ON	NONE	OFF	3-1	OPEN	OPEN	SPST 
SP	AS12 AS13	ON ON	NONE OFF	ON ON	2-1 2-1	OPEN OPEN	2-3 2-3	SPDT 
DP	AS22 AS23	ON ON	NONE OFF	ON ON	2-1 5-4 2-1 5-4	OPEN OPEN	2-3 5-6 2-3 5-6	DPDT 

Note: Terminal numbers are not actually on the switch.

For 3 Throw (3-On)

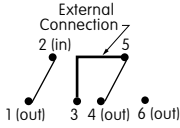
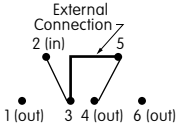
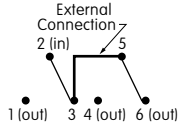
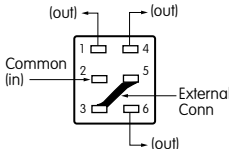
Pole	Model	Connected Terminals & Schematics			External Connection
		Left	Center	Right	
SP	AS24	ON  2-1 5-4	ON  2-3 5-4	ON  2-3 5-6	The SP3T model utilizes a double pole base. External connections must be made during field installation. 

ACTUATORS

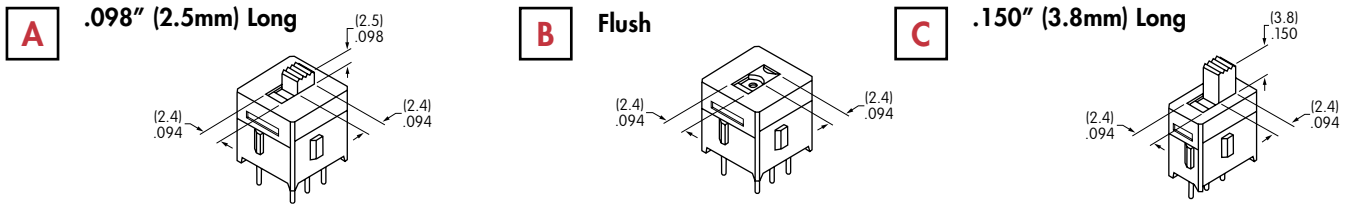

Actuator Color: Gray standard; contact factory for other colors.

PC TERMINALS

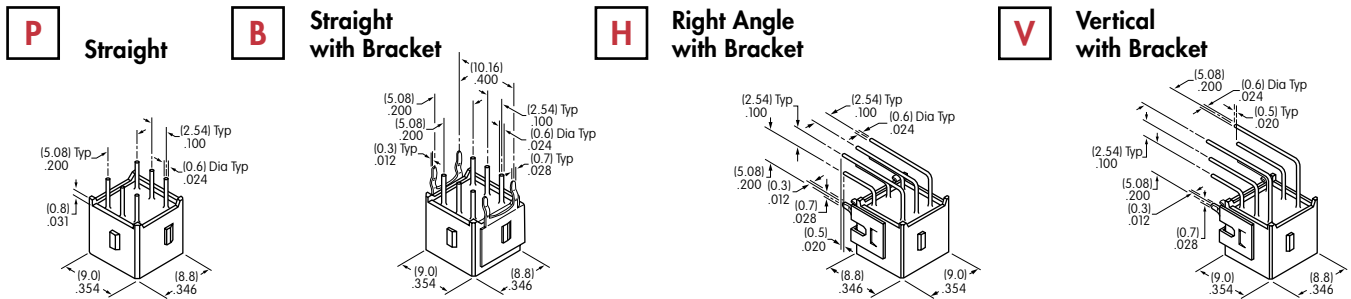

Use of a support bracket is recommended to increase PCB mounting strength and stability.

TYPICAL SWITCH DIMENSIONS

Single Pole

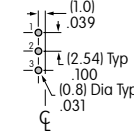
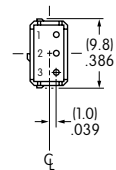
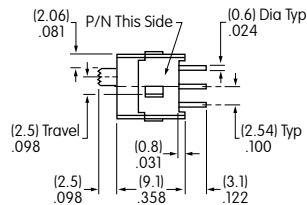
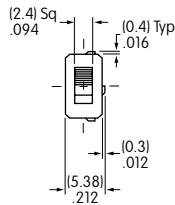

Actuator shown in LEFT position

Single throw models do not have terminal 2.

Straight PC



AS12AP

Double Pole

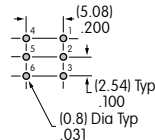
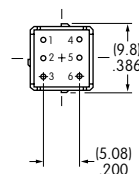
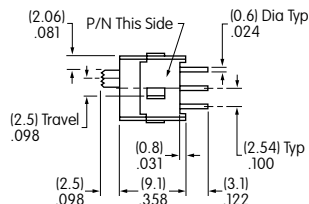
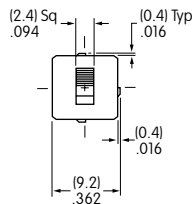

Actuator shown in LEFT position

Straight PC



AS22AP

Single Pole

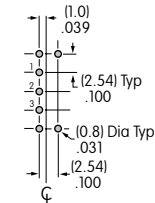
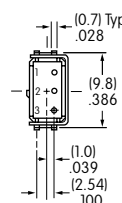
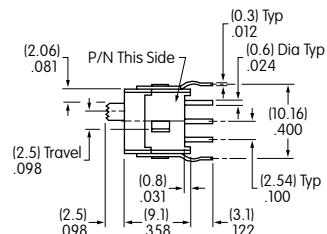
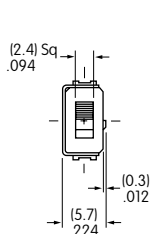

Actuator shown in LEFT position

Straight PC • Bracket



AS12AB

TYPICAL SWITCH DIMENSIONS

Straight PC • Bracket

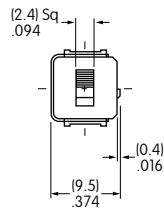

Double Pole

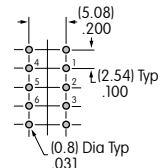
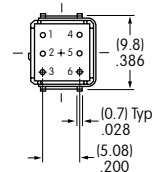
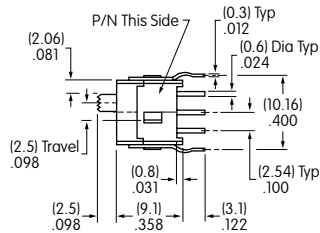

AS22AB

Actuator shown in LEFT position

Right Angle PC

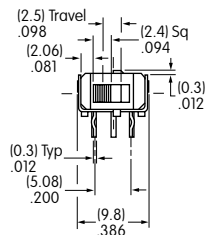

Single Pole

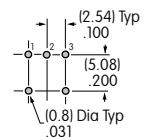
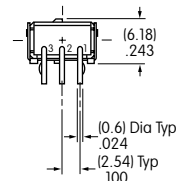
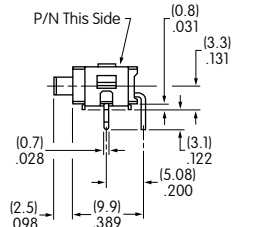

AS12AH

Actuator shown in LEFT position

Right Angle PC

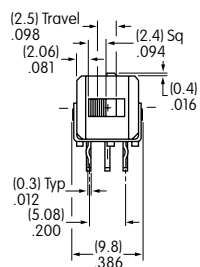

Double Pole

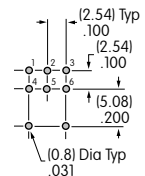
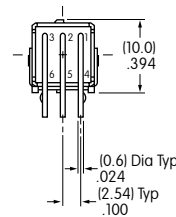
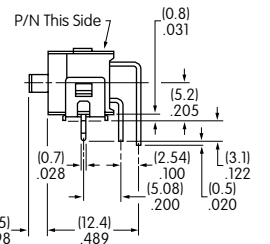

AS22AH

Actuator shown in LEFT position

Vertical PC

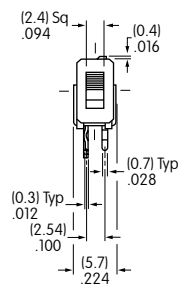

Single Pole

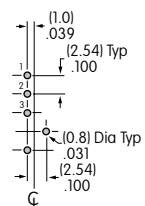
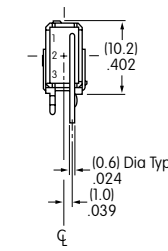
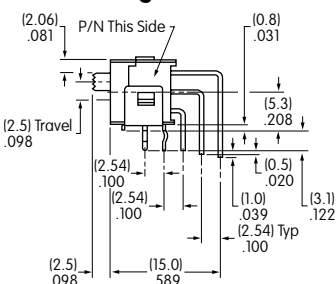

AS12AV

Actuator shown in LEFT position

Vertical PC

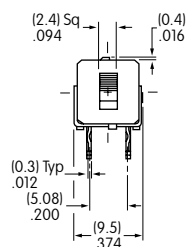

Double Pole

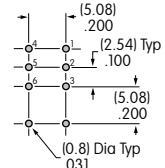
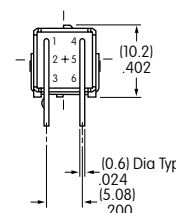
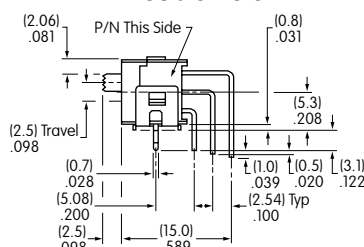

AS22AV

Actuator shown in LEFT position