

Distinctive Characteristics

Bright illumination with numerous color variations. Spot illumination available. Square, rectangular, and round shaped caps.

Incandescent, LED, and neon lamps. Front panel relamping.

Choice of bright or super bright LEDs in red, amber, green, white, and blue.

Latchdown feature gives indication of circuit status. Audible and tactile feedback with smooth and responsive operation.

Snap-action mechanism for long life.

Stainless steel frame on snap-in models has a specially designed projection, which prevents rotation and correctly orients switch in panel.

12mm (.472") body diameter.

Molded-in terminals lock out flux, dust and other contaminants.

8mm (.315") panel thickness capability. Rear panel bushing or snap-in mounting.

Optional PCB adaptors in straight and right angle types.

Nonilluminated models available and shown in Pushbutton section.

Matching indicators available and shown in Indicator section.



Actual Size

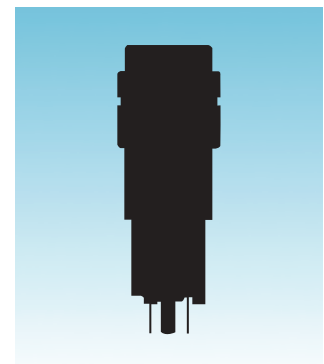

General Specifications

Electrical Capacity (Resistive Load)

Power Level (code W): 1A @ 125/250V AC or 1A @ 30V DC
Logic Level (code G): 0.4VA maximum @ 28V AC/DC maximum
 Note: See Supplement Index (page Z1) to find explanation of operating range.

Other Ratings

Contact Resistance: 50 milliohms maximum
Insulation Resistance: 1,000 megohms minimum @ 500V DC
Dielectric Strength: For Silver: 1,000V AC minimum between contacts for 1 minute minimum & 1,500V AC minimum between contacts & case for 1 minute minimum;
 For Gold: 750V AC minimum between contacts for 1 minute minimum & 1,500V AC minimum between contacts & case for 1 minute minimum
Mechanical Life: 100,000 operations minimum
Electrical Life: 50,000 operations minimum for silver; 100,000 operations minimum for gold
Nominal Operating Force: Single pole 100 ~ 250 grams for maintained & 100 ~ 200 grams for momentary;
 Double pole 150 ~ 350 grams for maintained & 150 ~ 300 grams for momentary
Contact Timing: Nonshorting (break-before-make)
Travel: 2.2mm (.087") pretravel; 0.80mm (.031") overtravel; 3.0mm (.118") total travel

Materials & Finishes

Housing: Polyamide
Movable Contactor: Silver for power circuit; copper with gold plating for logic level circuit
Stationary Contacts: Silver for power circuit; copper with gold plating for logic level circuit
Housing Base: Polyamide **Terminal Base:** Polyester
Common Terminals: Phosphor bronze with silver flash plating for power circuit;
 Phosphor bronze with gold flash plating for logic level circuit
End Terminals: Brass with silver flash plating for power circuit;
 Brass with gold flash plating for logic level circuit
Lamp Terminals: Phosphor bronze with nickel flash plating



Environmental Data

Operating Temp Range: -25°C through +50°C (-13°F through +122°F)
Humidity: 90 ~ 95% humidity for 96 hours @ 40°C (104°F)
Vibration: 10 ~ 55Hz with peak-to-peak amplitude of 1.5mm traversing the frequency range & returning in 1 minute; 3 right angled directions for 2 hours
Shock: 50G (490m/s²) acceleration (tested in 6 right angled directions, with 3 shocks in each direction)

Installation

Mounting Torque: .78Nm (6.9 lb•in) maximum
Cap Installation Force: 4.51N (1.0 lbf) maximum downward force on cap
Soldering Time & Temperature: 3 seconds @ 350°C or 5 seconds @ 270°C
Process Seal: Not available

Standards & Certifications

Flammability Standards: UL94V-0 housing & base
UL Recognized:  Single & double pole models recognized at 1A @ 125/250V AC, 1A @ 30V DC, & 0.4A @ 28V DC; UL File No. WOYR2.E44145; add "/U" to end of part number to order UL mark on switch.
CSA Certified:  Single & double pole models recognized at 1A @ 125/250V AC, 1A @ 30V DC, & 0.4VA @ 28V maximum; CSA File No. 023535-0-000; add "/C" to end of part number to order CSA mark on switch.

TYPICAL SWITCH ORDERING EXAMPLE

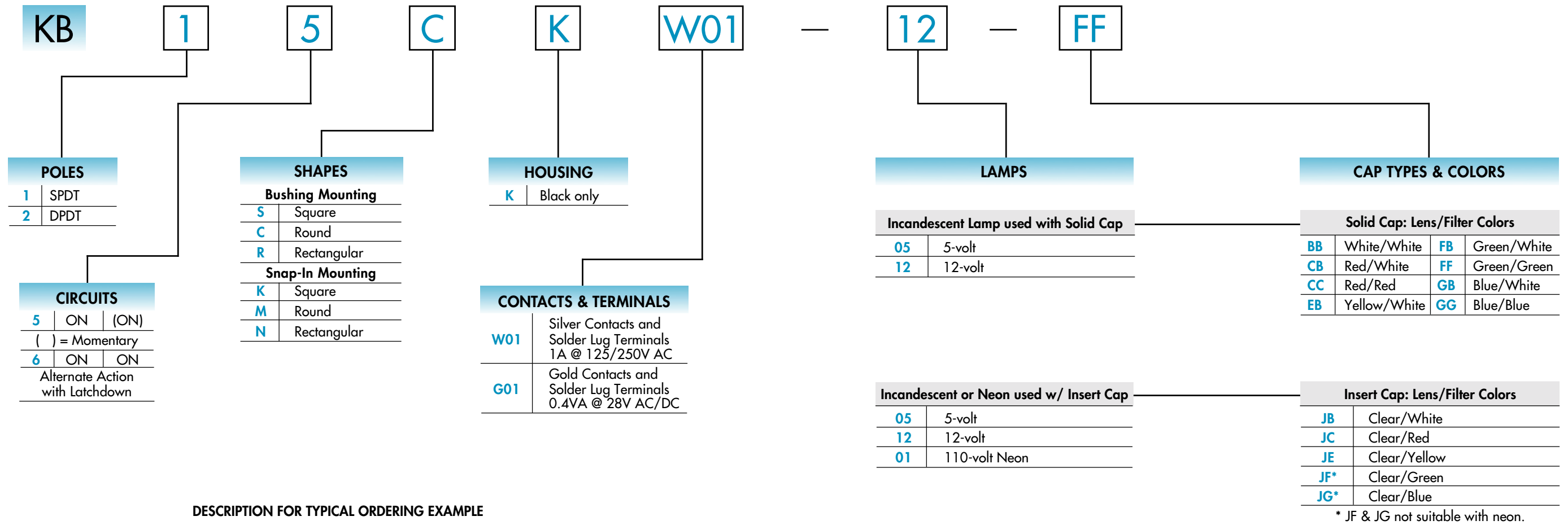

DESCRIPTION FOR TYPICAL ORDERING EXAMPLE
KB15CKW01-12-FF

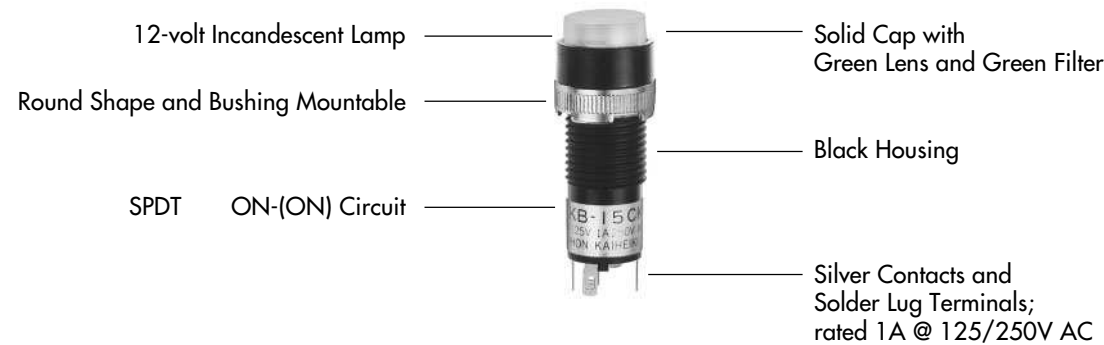

IMPORTANT:
Switches are supplied without UL & CSA marking unless specified. Specific models & ratings noted on General Specifications page.

Bright LED used with Cap for LED			
Colors		Resistor	
5C	Red	No Code	No Resistor
5D	Amber	05	5-volt
5F	Green	12	12-volt
		24	24-volt
Super Bright LED used with Cap for LED			
6B	White		
6F	Green		
6G	Blue		

LED Cap: Lens/Diffuser Colors	
AB	Square Spot Illuminated Black Cap/White Window
JB	Clear/White
JC	Clear/Red
JD	Clear/Amber
JF	Clear/Green

LED Cap: Lens/Diffuser Colors	
JB	Clear/White

POLES & CIRCUITS

Pole	Model	Plunger Position () = Momentary		Connected Terminals		Throw & Power/Lamp Schematics
		Normal	Down	Normal	Down	
SP	KB15 KB16*	ON ON	(ON) ON	2-3	2-1	SPDT
DP	KB25 KB26*	ON ON	(ON) ON	2-3 5-6	2-1 5-4	DPDT

* When in latched position for the alternate circuit, cap position is 1.4mm (.055") above the built-in bezel.

SHAPES & MOUNTING TYPES

Bushing Mounting

S

.551" Square

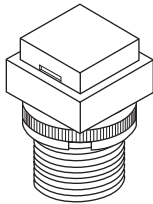

C

.551" Round

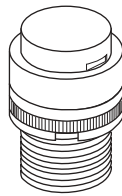

R

.551" x .728" Rectangular

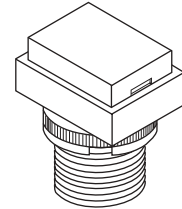

The bezel is an integral part of the switch body. One mounting nut AT057 supplied with each switch.

Snap-In Mounting

K

.551" Square

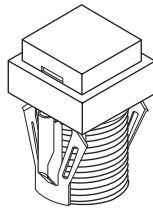

M

.551" Round

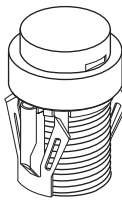

N

.551" x .728" Rectangular

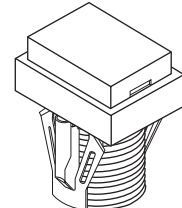

The bezel is an integral part of the switch body.

Panel Cutouts

Bushing Mounting

Without Keyway

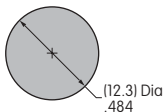

Panel Thickness:
0.5 ~ 8mm
(.020 ~ .315")

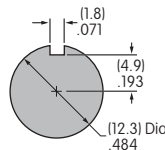

With Keyway

Snap-In Mounting

Panel Thickness:
1.0 ~ 3.5mm
(.039 ~ .138")

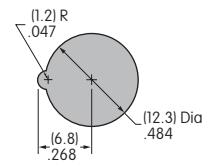

Panel thicknesses, when using optional accessories, are shown with the accessories at the end of this KB section.

HOUSING

K

Housing available in black only. Shroud is an integral part of the switch body.

CONTACT MATERIALS, RATINGS, & TERMINALS

W Silver Contacts

Power Level
1A @ 125V AC & 250V AC

G Gold Contacts

Logic Level
0.4VA maximum @ 28V AC/DC

01 Solder Lug

The .039" x .079" oblong hole accommodates one solid 20-gauge wire or two solid or stranded 22-gauge wires.

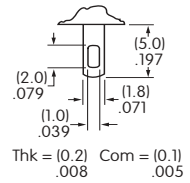

See Supplement Index (page Z1) for complete explanation of operating range.

A partitioned plastic guard is supplied with each switch to provide insulation between terminals. Installation steps:

- (1) Identify wire-to-terminal connections.
- (2) Thread wires through the guard.
- (3) Solder the connections.
- (4) Push the guard fully onto the switch body.

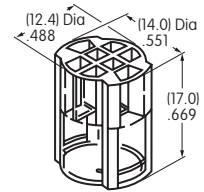

LAMP CODES & SPECIFICATIONS



Electrical specifications are determined at a basic temperature of 25°C. Lamp circuit is independent of switch operation.

For dimension drawings of lamps see the Accessories & Hardware Index (page Y1).



If the source voltage is greater than rated voltage, a ballast resistor is required. The ballast resistor calculation and more lamp detail are shown in the Supplement; see Supplement Index (page Z1).

Ambient Temperature Range for lamps below: -25°C ~ +50°C.



Incandescent & Neon Lamps

			05	12	01	Recommended Resistors for Neon: 33K ohms for 110V AC; 100K ohms for 220V AC
AT611 Incandescent	AT615 Neon	Voltage	5V AC	12V AC	110V AC	
		Current	115mA	60mA	1.5mA	
T-1 Bi-pin		Endurance	7,000 average		10,000	

Bright LED without Resistor

		Red	Amber	Green	No Code No Resistor		
AT635		5C	5D	5F	30mA	30mA	30mA
LEDs are colored in OFF state.		Color Codes:			I_{FM}	20mA	40mA
					I_F	1.9V	2.1V
T-1 1/2 Bi-pin					V_F	5V	5V
					V_{RM}	0.42mA/°C	0.29mA/°C
					ΔI_F	—	—

Bright LED with Resistor

		Red	Amber	Green	Resistor Codes		
AT634		5C	5D	5F	05	12	24
LEDs are colored in OFF state.		Color Codes:			I_{FM}	—	—
					I_F	25mA	10mA
T-1 1/4 Bi-pin					V_F	5V	5V
					V_{RM}	4V	16V
					ΔI_F	—	—

AT634
5-volt
2-element
with 1 Resistor

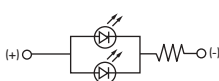

AT634
12-volt
4-element
with 2 Resistors

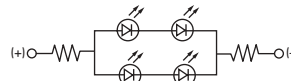

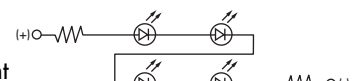

AT634
24-volt
4-element
with 2 Resistors



LAMP CODES & SPECIFICATIONS

Super Bright Single Element LED

<p>AT625G Blue</p> <p>AT631B White</p> <p>AT632F Green</p>  <p>T-1 Bi-pin</p>			Color	6B White	6F Green	6G Blue	
			Forward Peak Current	I_{FM}	30mA	30mA	30mA
			Continuous Forward Current	I_F	20mA	20mA	20mA
			Forward Voltage	V_F	3.6V	3.5V	3.6V
			Reverse Peak Voltage	V_{RM}	5V	5V	5V
			Current Reduction Rate Above 25°C	ΔI_F	0.50mA/°C	0.50mA/°C	0.50mA/°C
			Ambient Temperature Range		-25°C ~ +50°C.		

CAP TYPES & COLOR COMBINATIONS

Color Codes: **A** Black **B** White **C** Red **E** Yellow **F** Green **G** Blue **J** Clear

Solid Cap for Incandescent Lamp

Lens/Filter Colors Available:

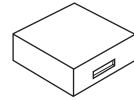
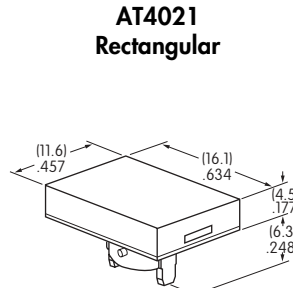
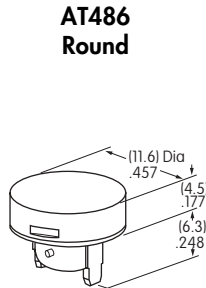
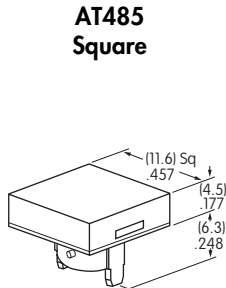
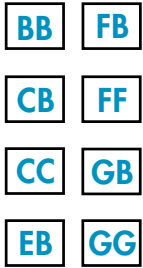

Translucent Colored Lens



Translucent Colored Filter



Lamp AT611

Material: Polycarbonate Finish: Glossy

Insert Cap for Incandescent or Neon Lamp

Lens/Filter Colors Available:

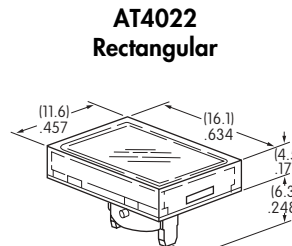
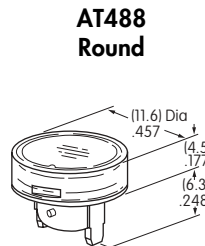
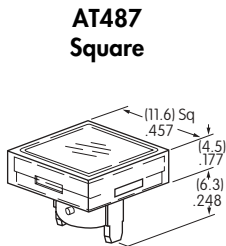

Transparent Clear Lens



Translucent Colored Filter



Lamp AT611 Lamp AT615

JF and JG not suitable with neon lamp.

Material: Polycarbonate Finish: Glossy

CAP TYPES & COLOR COMBINATIONS

Color Codes: A Black B White C Red D Amber E Yellow F Green G Blue J Clear

Spot Illuminated Cap for Bright LED without Resistor or with Resistor

Cap/Window Colors Available:

AB Opaque Black Cap with Translucent White Window for Spot Illumination

AT4051
Square

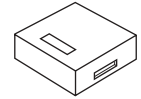
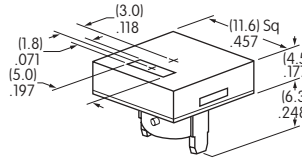

Bright LED
AT635

Bright LED
AT634

Material: Polycarbonate Finish: Matte

Cap for Bright LED without Resistor or LED with Resistor

Lens/Diffuser Colors Available: (AT4133, 4132, 4134 white diffusers; AT4158, 4160, 4159 colored diffusers)

JB

AT4133

Square

AT4132

Round

AT4134

Rectangular



Transparent Clear Lens

JC

AT4158

AT4160

AT4159



Translucent Diffuser

JD

JF

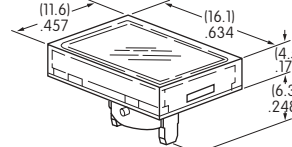
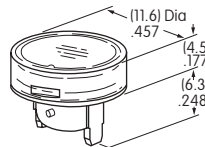
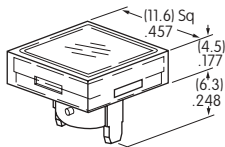

Bright LED
AT635

Bright LED
AT634

Material: Polycarbonate Finish: Glossy

Cap for Super Bright LED

Lens/Diffuser Colors Available:

JB

AT4133
Square

AT4132
Round

AT4134
Rectangular



Translucent Clear Lens

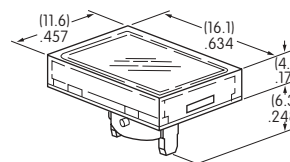
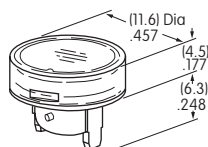
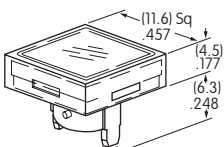

Translucent White Diffuser

Super Bright LEDs
AT625
AT631 AT632



Material: Polycarbonate Finish: Glossy

TYPICAL SWITCH DIMENSIONS

Square • Bushing Mounting

Single & Double Pole

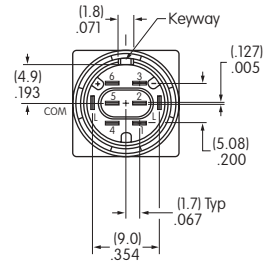
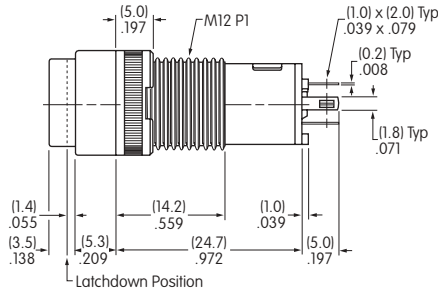
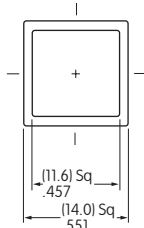

KB15SKW01-05-GG

Terminals 4, 5, & 6 are not on single pole models.

Round • Bushing Mounting

Single & Double Pole

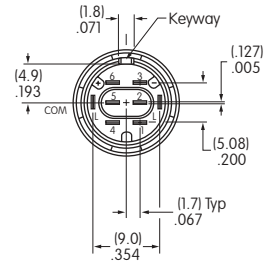
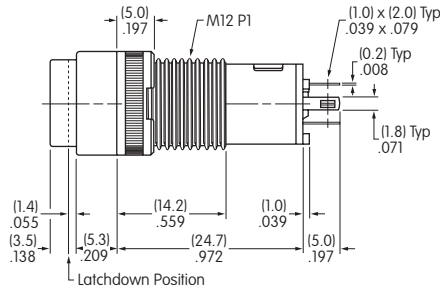
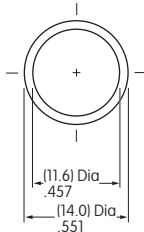

KB25CKW01-05-GG

Terminals 4, 5, & 6 are not on single pole models.

Rectangular • Bushing Mounting

Single & Double Pole

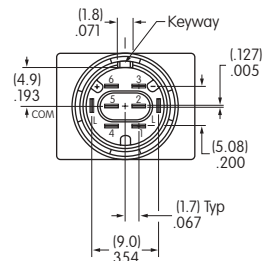
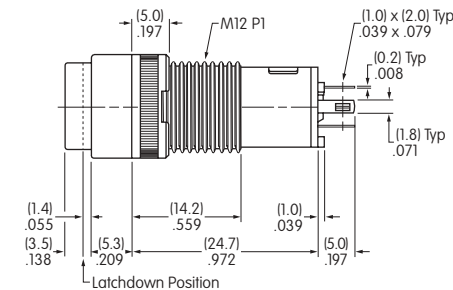
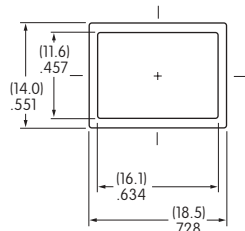

KB15RKW01-05-GG

Terminals 4, 5, & 6 are not on single pole models.

TYPICAL SWITCH DIMENSIONS

Square • Snap-In Mounting

Single & Double Pole

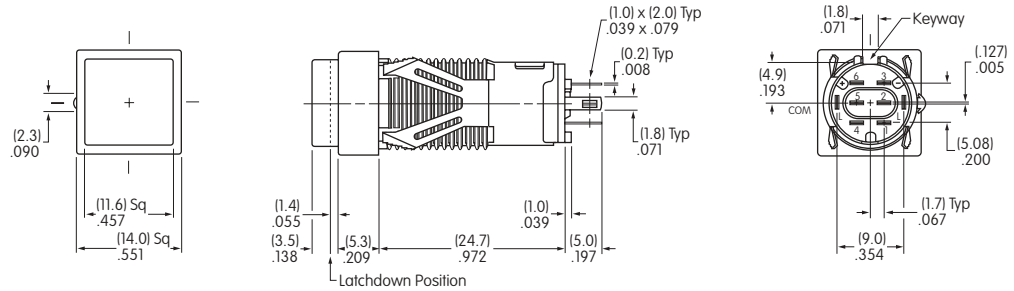

KB16KKW01-05-CB

Terminals 4, 5, & 6 are not on single pole models.

Round • Snap-In Mounting

Single & Double Pole

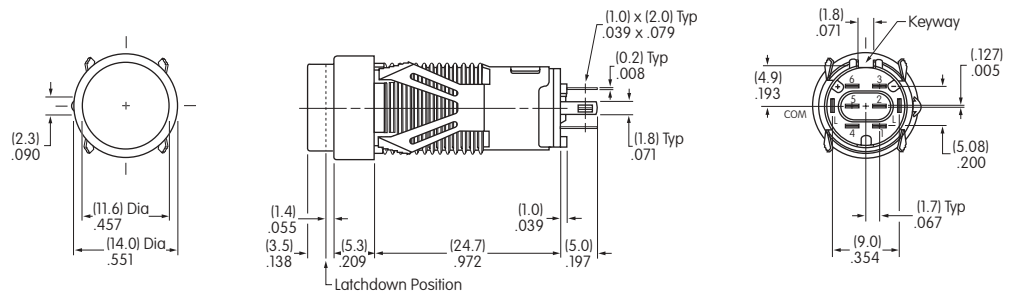

KB26MKW01-05-CB

Terminals 4, 5, & 6 are not on single pole models.

Rectangular • Snap-In Mounting

Single & Double Pole

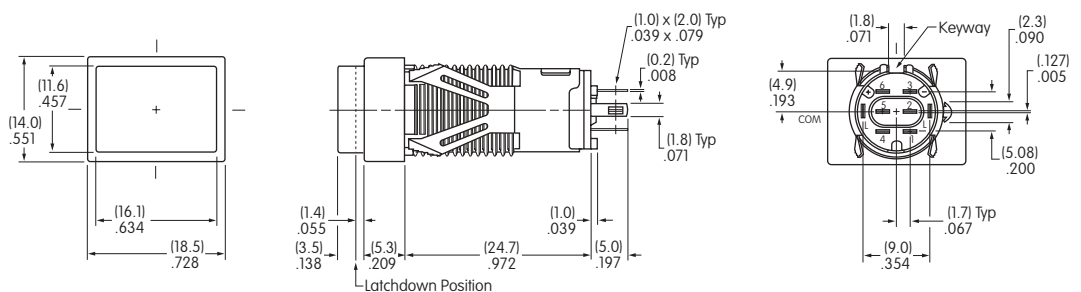

KB16NKW01-05-CB

Terminals 4, 5, & 6 are not on single pole models.

OPTIONAL ACCESSORIES

PCB Adaptors

AT701
Single Pole
Straight PC
Terminals



AT702
Double Pole
Straight PC
Terminals



AT077
Single Pole
Right Angle PC
Terminals

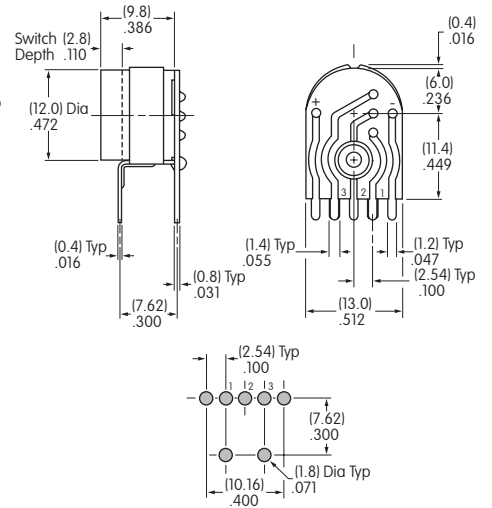
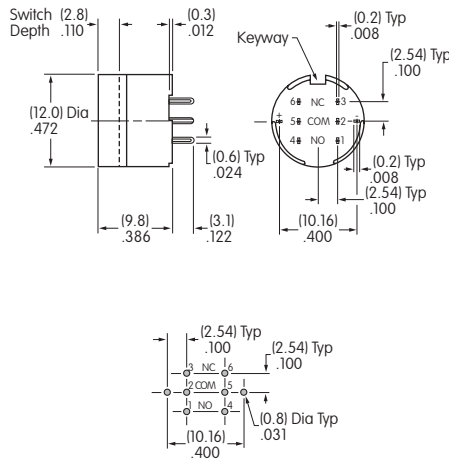
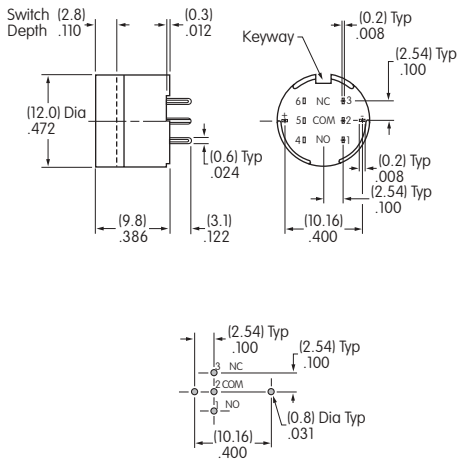

Material: Glass reinforced polyamide

Note: Order adaptors separately.

Splash Covers

Panel Thickness Range: 0.5 ~ 6.8mm (.020 ~ .268") for Bushing Mounting 0.5 ~ 2.0mm (.020 ~ .079") for Snap-in Mounting
 Splash Covers reduce the depth of switch behind panel by .047".

AT495
For Square & Round



AT4025
For Rectangular

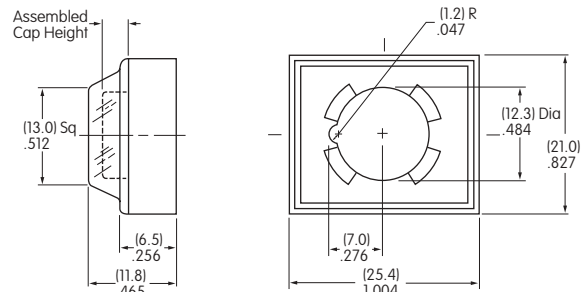
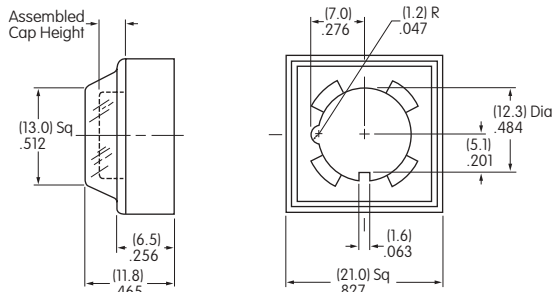

Material: Lid: PVC PVC loses pliability below 0°C (32°F). Base: Polyamide

OPTIONAL ACCESSORIES

Protective Guards

AT494
For Square & Round



AT4024
For Rectangular



Panel Thickness
Range:

0.5 ~ 6.8mm
(.020 ~ .268")

for Bushing Mounting

0.5 ~ 2.3mm
(.020 ~ .091")

for Snap-in Mounting

Protective Guards reduce
the depth of switch
behind panel by .047".

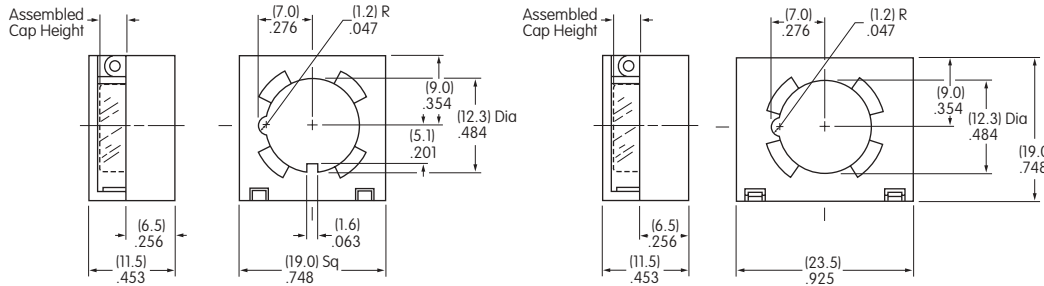

Material: Cover: Polycarbonate

Base: Polyamide

ASSEMBLY INSTRUCTIONS

Cap Removal & Installation

For alternate action models cap must be in UP position for cap removal. Indentations on opposite sides of the cap provide an easy way to lift the cap out of the holder, using either the finger nails, or cap extractor AT109.

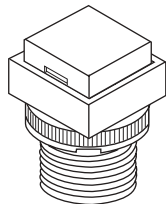

LED Polarity & Orientation in Lamp Socket

Super Bright LEDs AT625, AT631, & AT632 are electrostatic sensitive.



LED
AT635

LED
AT634

LEDs
AT625
AT631
AT632

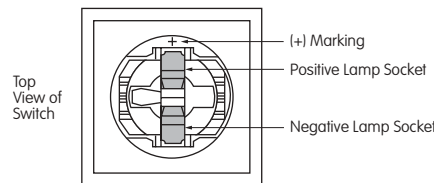
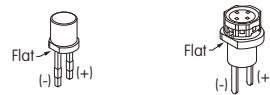

Cap Replacement

Note that the cap has a pair of round tabs and a pair of long tabs which should be used for correctly replacing the cap in its holder. Using the long tabs as guides, slide the cap with the long tabs moving into the slots on opposite sides of the cap holder. Then, the round tabs will snap into notches on the other two sides of the holder.

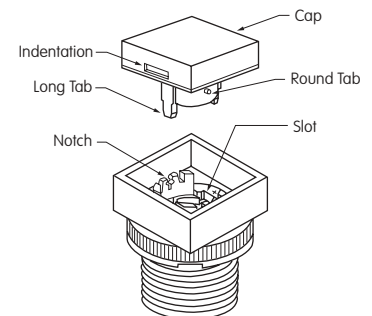

AT108 Socket Wrench
for Bushing Mounting

Overtightening the mounting nut may damage the switch housing.



AT109 Cap Extractor

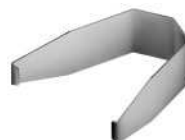

AT111 Lamping Tool



LEGENDS

General information and basic specifications are presented here for customers who want to do their own legends.

Suggested Printable Area for Lens



Recommended Print Method:

Screen Print or Pad Print

Epoxy based ink is recommended.

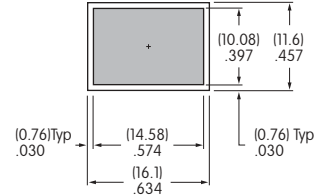
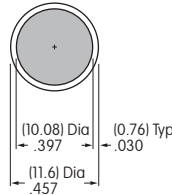
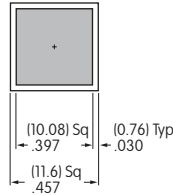

Shaded areas are printable areas.

Suggested Printable Area for Film Insert

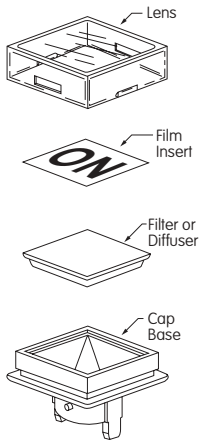

Film Material and Thickness:

Clear Polyester, 4 mil max.

Recommended Print Method:

Screen Print with Epoxy Based Ink

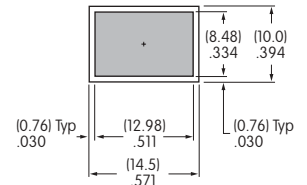
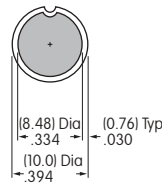
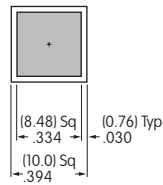

Shaded areas are printable areas.

Additional Methods

Additional methods for legends are engraving the lens and laser printing on film inserts.

Maximum depth for engraving is 0.3 mm (.012") on the cap lens.

Enamel paint is recommended to fill the engraved area.

LEGEND PACKET

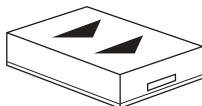

1. To order caps with legends, contact the factory and request the KB Legend Packet.
2. Once you determine your desired legend, fill out the ordering work sheet included in the packet.
3. Return the completed work sheet to receive a quotation.