

General Specifications

Electrical Capacity (Resistive Load)

Logic Level: 0.4VA maximum @ 28V AC/DC maximum
(Applicable Range 0.1mA ~ 0.1A @ 20mV ~ 28V)
Note: Find additional explanation of operating range in Supplement section

Other Ratings

Contact Resistance: 100 milliohms maximum
Insulation Resistance: 100 megohms minimum @ 500V DC
Dielectric Strength: 500V AC minimum for 1 minute minimum
Mechanical Life: 30,000 cycles minimum
Electrical Life: 20,000 cycles minimum
Static Capability: Withstands 15 kilovolts ESD
Nominal Operating Torque: .0002Nm (.0017 lb•in)
Contact Timing: Break-before-make
Angle of Throw: 45° for 3-position & 5-position

Materials & Finishes

Key: Polyacetal
Housing/Bushing: Glass fiber reinforced polyester (PBT)
Base: Glass fiber reinforced polyamide
Rotor & Stopper: Polyacetal
Tumbler Plate: Brass
Movable Contactor: Beryllium copper with gold plating
Stationary Contacts: Phosphor bronze with gold plating
Terminals: Phosphor bronze with gold plating
Mounting Bracket: Steel with tin plating

Environmental Data

Operating Temperature Range: -25°C through +70°C (-13°F through +158°F)
Humidity: 90 ~ 95% humidity for 240 hours @ 40°C (104°F)
Vibration: 10 ~ 55Hz with peak-to-peak amplitude of 1.5mm traversing the frequency range & returning in 1 minute; 3 right angled directions for 2 hours
Shock: 50G (490m/s²) acceleration (tested in 6 right angled directions, with 5 shocks in each direction)

PCB Processing

Soldering: Wave Soldering Recommended. See Profile A in Supplement section.
Manual Soldering: See Profile A in Supplement section.
Cleaning: Automated cleaning. See Cleaning specifications in Supplement section.

Standards & Certifications

The SK Series devices have not been tested for UL recognition or CSA certification. These switches are designed for use in a low-voltage, low-current, logic-level circuit. When used as intended in a logic-level circuit, the results do not produce hazardous energy.

Distinctive Characteristics

Housing and bushing of high insulating material withstands over 15 kilovolts of electrostatic discharge, thus providing antistatic protection.

Totally sealed construction with internal o-ring, with gasket between base and housing, and with insert-molded terminals, gives protection for automated processing techniques.

Subminiature size allows high density mounting.

Molded-in terminals prevent entry of flux and other contaminants.

Crimped bracket legs ensure secure PCB mounting and prevent dislodging during automated wave soldering.

Bifurcated, self-wiping contact mechanism provides unequalled logic-level reliability and smoother, positive detent actuation.

Detent mechanism, with its spring-operated steel ball, gives distinct feel and crisp actuation for accurate switch setting.

.100" x .100" (2.54mm x 2.54mm) terminal spacing conforms to standard PC board grid spacing.

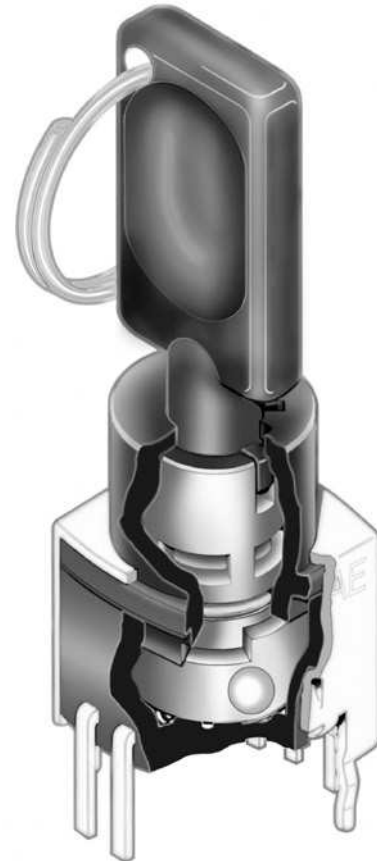

Actual Size

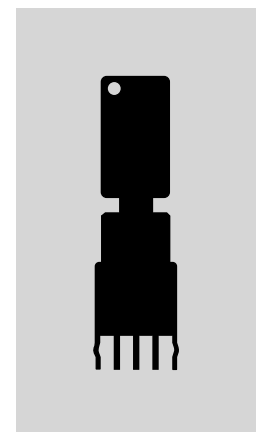

- Toggle
- Rockers
- Pushbuttons
- Illuminated PB
- Programmable
- F** Keylocks
- Rotaries
- Slides
- Tactiles
- Tilt
- Touch
- Indicators
- Accessories
- Supplement

TYPICAL SWITCH ORDERING EXAMPLE

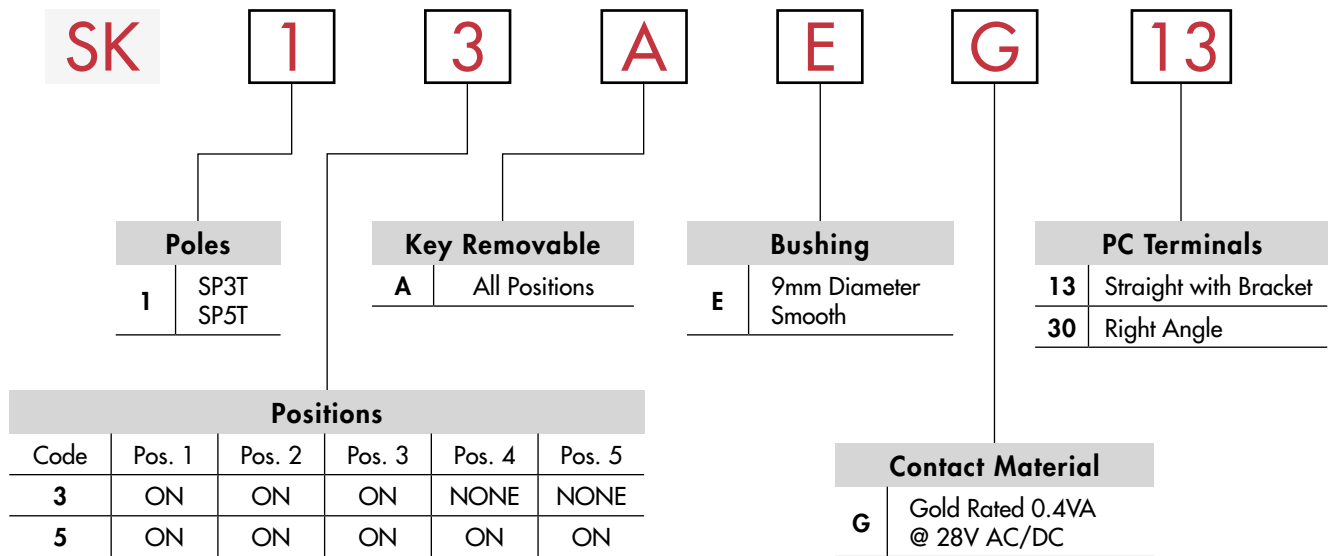

DESCRIPTION FOR TYPICAL ORDERING EXAMPLE

SK13AEG13

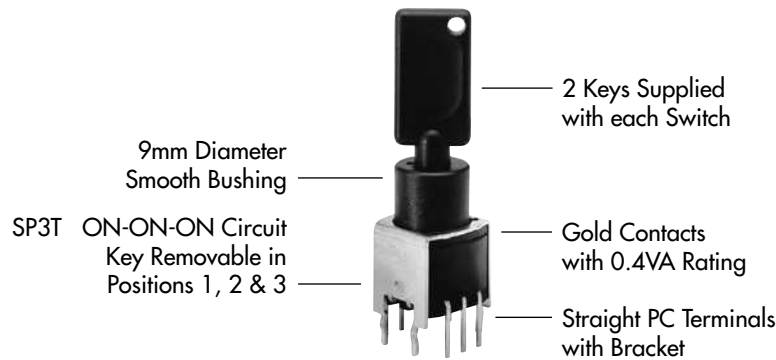

POLES, CIRCUITS & KEY-REMOVABLE POSITIONS

Pole & Throw	Model	Key Positions					Connected Terminals (Terminal numbers are not on switch)					Schematic	⊙ = Key Removable ● = Not Removable ✓ = Maximum Arc
		Pos 1	Pos 2	Pos 3	Pos 4	Pos 5	Pos 1	Pos 2	Pos 3	Pos 4	Pos 5		
SP3T	SK13A	ON	ON	ON	----	----	C1-2	C1-3	C1-4	----	----		
SP5T	SK15A	ON	ON	ON	ON	ON	C1-1	C1-2	C1-3	C1-4	C1-5		

KEY REMOVABLE

A All Positions
45° Angular Throw

BUSHING

E 9mm Diameter Smooth

CONTACT MATERIAL & RATING

G

Gold over Bronze or Copper

Logic Level

0.4VA @ 28V AC/DC maximum

TERMINALS

13

Straight PC with Bracket

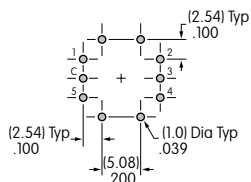
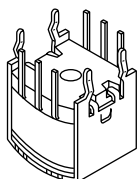

30

Right Angle PC

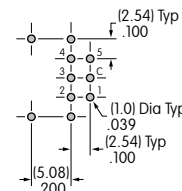
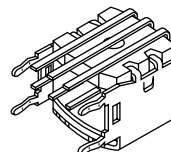

KEY

AT4094
Tubular Key

Material: Polyacetal

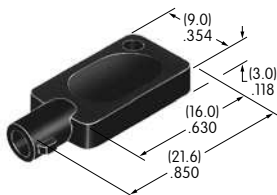

2 keys provided with each switch

TYPICAL SWITCH DIMENSIONS

Straight PC with Bracket

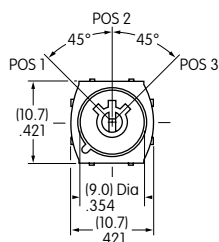

3 Position

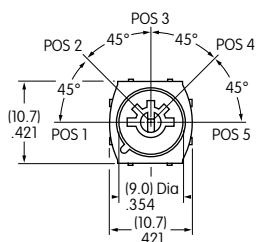

5 Position

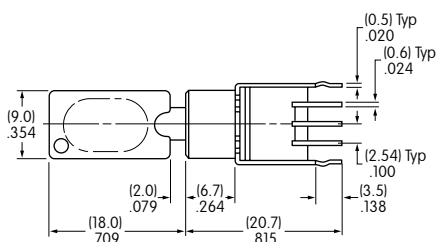

On 3-position models terminals 1 & 5 are support pins.

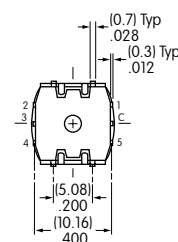

SK13AEG13



Right Angle PC

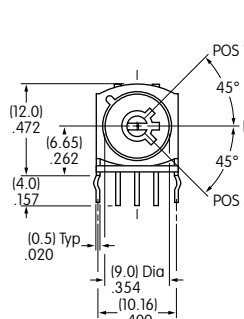

3 Position

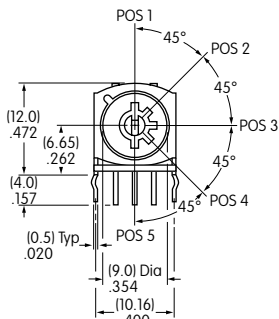

5 Position

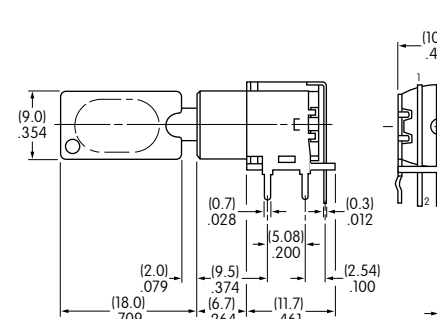

On 3-position models terminals 1 & 5 are support pins.

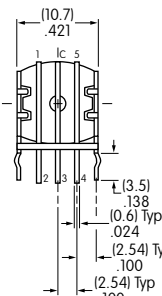

SK15AEG30



Toggles
Rockers
Pushbuttons
Illuminated PB
Programmable
Keylocks
Rotaries
Slides
Tactiles
Tilt
Touch
Indicators
Accessories
Supplement