

## GENERAL SPECIFICATIONS FOR SW3000s

Toggles

Rockers

Pushbuttons

Illuminated PB

Programmable

Keylocks

Rotaries

Slides

Tactiles

Tilt

Touch

Indicators

Accessories

Supplement

**B Electrical Capacity (Resistive & Inductive Load)****Power Level:** Shown in the following tables**Other Ratings**

**Contact Resistance:** 10 milliohms maximum  
**Insulation Resistance:** 1,000 megohms minimum @ 500V DC  
**Dielectric Strength:** 2,000V AC minimum for 1 minute minimum  
**Mechanical Life:** 30,000 operations minimum  
**Electrical Life:** 10,000 operations minimum  
**Angle of Throw ( $\alpha$ ):** Shown on drawings or following tables

**Materials & Finishes**

**Rocker:** Urea resin; all rockers are white.  
**Mounting Frame:** Steel with chromate plating over zinc plating  
**Case Cover/Insulator:** Phenolic resin  
**Case:** Melamine phenol  
**Movable Contactor Plate:** Copper with silver plating  
**Movable & Stationary Contacts:** Silver alloy plus copper with silver plating  
**Terminals:** Copper with tin plating

**Environmental Data**

**Operating Temp Range:** -10°C through +70°C (+14°F through +158°F)  
**Sealing:** Dustproof cover of silicone rubber on SW3006A, SW3007A, & SW3008A

**Installation**

**Maximum Panel Thickness:** Shown with following drawings  
**Soldering Time & Temperature:** Manual Soldering: See Profile A in Supplement section.

**Standards & Certifications**

- UL: File No. E44145 - Recognized only when ordered with marking on switch.**  
 Add "/U" or "/CUL" to end of part number to order UL recognized switch.  
 UL or cULus recognition designated beside part numbers on following pages.  
 See Supplement section to find UL or cULus rating details.
- CSA: File No. 023535\_0\_000 - Certified only when ordered with marking on switch.**  
 Add "/C" to end of part number to order CSA certified switch.  
 CSA certification designated beside part numbers on following pages.  
 See Supplement section to find CSA rating details.
- VDE: License No. 119189 - Approved only when ordered with marking on switch.**  
 Add "/V" to end of part number to order VDE approved switch.  
 SW3006A at 20A @ 125V AC & 10A @ 250V AC

## SINGLE POLE WITH SOLDER LUG \*

* UL & CSA recognized only when ordered with marking on switch (see General Specs)		Rocker Position/Connected Terminals						Electrical Capacity					
Model	* Approvals		Pole	Down		Center	Up		Resistive		Inductive	$\alpha =$ Angle of Throw	
									AC 125V	AC 250V	DC 30V		AC 125V PF 0.6
SW3001A	✓	✓	SPST	ON	1-3	NONE	OFF	—	15A	6A	15A	10A	24°
SW3002A	✓	✓	SPDT	ON	2-3	NONE	ON	2-1	15A	6A	15A	10A	24°
SW3003A	✓	✓	SPDT	ON	2-3	OFF	ON	2-1	15A	6A	15A	10A	28°

**Throw & Schematics:** SPST INTERNAL CONNECTION Note: Terminal numbers are actually on the switch.

\* Wire harness & cable assemblies offered only in Americas.

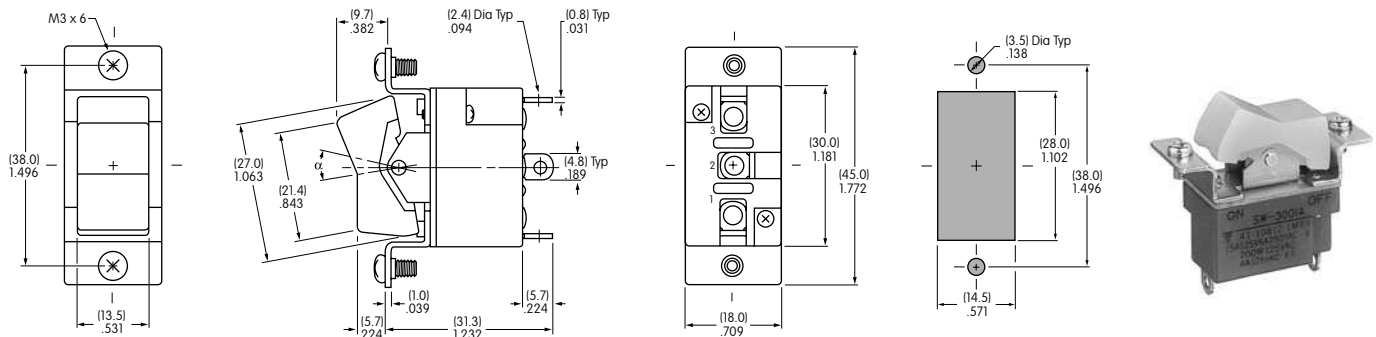

Maximum Effective Panel Thickness:

SW3001A does not have terminal 2. .197" (5.0mm) for SW3001A & SW3002A models; .177" (4.5mm) for SW3003A models **SW3001A**

## DOUBLE POLE WITH SOLDER LUG \*

* UL, cULus & CSA recognized only when ordered with marking on switch (see General Specs)		Rocker Position/Connected Terminals ( ) = Momentary						Electrical Capacity						
Model	* Approvals			Down		Center	Up		Resistive		Inductive	$\alpha =$ Angle of Throw		
									AC 125V	AC 250V	DC 30V		AC 125V PF 0.6	
SW3006A	✓	✓	✓	DPDT	ON	2-3 5-6	NONE	ON	2-1 5-4	20A	10A	20A	10A	24°
SW3007A	—	—	✓	DPDT	ON	2-3 5-6	OFF	ON	2-1 5-4	15A	6A	15A	10A	28°
SW3008A	—	—	—	DPDT	(ON)	2-3 5-6	OFF	(ON)	2-1 5-4	15A	6A	15A	10A	24°

**Throw & Schematic:** DPDT Note: Terminal numbers are actually on the switch.

\* Wire harness & cable assemblies offered only in Americas.

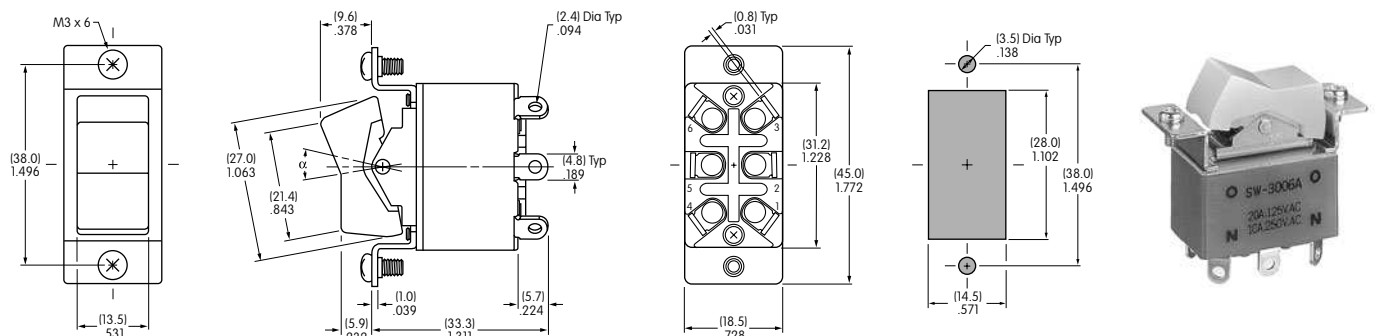

Maximum Effective Panel Thickness:

.197" (5.0mm) for SW3006A & SW3008A models; .177" (4.5mm) for SW3007A models **SW3006A**

## GENERAL SPECIFICATIONS FOR SW3800s

Toggle

Rockers

Pushbuttons

Illuminated PB

Programmable

Keylocks

Rotaries

Slides

Tactiles

Tilt

Touch

Indicators

Accessories

Supplement

### B Electrical Capacity (Resistive & Inductive Load)

**Power Level:** Shown in the following tables  
 Note: See Supplement section for details of design for inductive DC loads.

### Other Ratings

**Contact Resistance:** 10 milliohms maximum  
**Insulation Resistance:** 1,000 megohms minimum @ 500V DC  
**Dielectric Strength:** 2,000V AC minimum for 1 minute minimum  
**Mechanical Life:** 50,000 operations minimum  
**Electrical Life:** 25,000 operations minimum  
**Angle of Throw:** Shown on following drawings  
**Nominal Operating Force:** 1,800 grams for SW3822  
 2,200 grams for SW3823 Off to On  
 800 grams for SW3823 On to Off

### Materials & Finishes

**Rocker:** Urea resin; all rockers are white.  
**Mounting Frame:** Steel with chromate plating over zinc plating  
**Case Cover/Insulator:** Phenolic resin  
**Case:** Melamine phenol  
**Movable Contacts:** Copper with silver plating  
**Stationary Contacts:** Silver alloy plus copper with silver plating  
**Terminals:** Brass (terminal screws of brass with nickel plating)

### Environmental Data

**Operating Temp Range:** -10°C through +70°C (+14°F through +158°F)

### Standards & Certifications

**UL:** **File No. E44145 - Recognized only when ordered with marking on switch.**  
 Add "/U" or "/CUL" to end of part number to order UL recognized switch.  
 UL or cULus recognition designated beside part numbers on following pages.  
 See Supplement section to find UL or cULus rating details.

**CSA:** **File No. 023535\_0\_000 - Certified only when ordered with marking on switch.**  
 Add "/C" to end of part number to order CSA certified switch.  
 CSA certification designated beside part numbers on following pages.  
 See Supplement section to find CSA rating details.

### Wiring for DC400V 10A

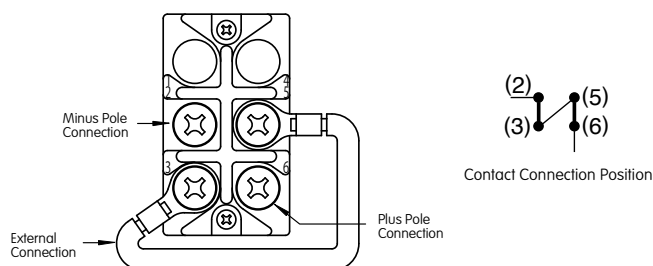

## DOUBLE POLE WITH SCREW LUG

Model	*Approvals UL cULus CSA	Pole	Rocker Position/Connected Terminals						Electrical Capacity									
			Down		Center	Up		Resistive				Inductive						
			ON	2-3 5-6	NONE	OFF	—	AC 125V	AC 250V	DC 30V	DC 48V	DC 125V	DC 250V	DC 400V	AC 125V PF 0.6	AC 250V PF 0.6		
SW3821	✓	✓	✓	DPST	ON	2-3 5-6	NONE	OFF	—	30A	30A	30A	—	1A	—	—	30A	15A
SW3822	✓	✓	✓	DPDT	ON	2-3 5-6	NONE	ON	2-1 5-4	30A	30A	30A	—	1A	—	—	30A	15A
SW3823	✓	✓	✓	DPDT	ON	2-3 5-6	OFF	ON	2-1 5-4	30A	30A	30A	—	1A	—	—	30A	15A
SW3821D	✓	✓	✓	DPST	ON	2-3 5-6	NONE	OFF	—	—	—	30A	30A	20A	15A	4A (10A)	—	—
SW3822D	✓	✓	✓	DPDT	ON	2-3 5-6	NONE	ON	2-1 5-4	—	—	30A	30A	20A	15A	4A	—	—
SW3823D	✓	✓	✓	DPDT	ON	2-3 5-6	OFF	ON	2-1 5-4	—	—	30A	30A	15A	—	—	—	—

Throw & Schematics:

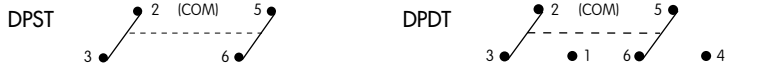

Note: Terminal numbers are actually on the switch.

\* UL/CUL & CSA for the following ratings: UL/CUL: 30A @ 30V DC, 15A @ 125V DC; CSA: 30A @ 30V DC, 15A @ 125V DC

\* UL, cULus & CSA recognized only when ordered with marking on switch (see General Specs)

( ) capacity is due to series wiring, see General Specifications page.

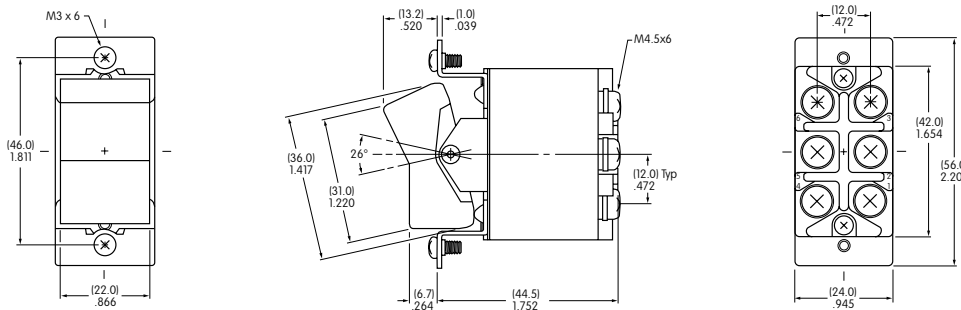

SW3821 & SW3821D do not have terminals 1 & 4.

Maximum Effective Panel Thickness .177" (4.5mm). Panel cutout shown below.

**SW3822**

## THREE POLE WITH SCREW LUG

Model	*Approvals UL cULus CSA	Pole	Rocker Position/Connected Terminals						Electrical Capacity						
			Down		Center	Up		Resistive				Inductive			
			ON	2-3 5-6 8-9	NONE	OFF	—	AC 125V	AC 250V	DC 30V	DC 125V	DC 250V	DC 400V	AC 125V PF 0.6	AC 250V PF 0.6
SW3831	✓	✓	✓	3PST	ON	2-3 5-6 8-9	NONE	OFF	—	30A	30A	30A	1A	30A	15A
SW3832	✓	✓	✓	3PDT	ON	2-3 5-6 8-9	NONE	ON	2-1 5-4 8-7	30A	30A	30A	1A	30A	15A
SW3833	✓	✓	✓	3PDT	ON	2-3 5-6 8-9	OFF	ON	2-1 5-4 8-7	30A	30A	30A	1A	30A	15A
SW3831D	✓	✓	✓	3PST	ON	2-3 5-6 8-9	NONE	OFF	—	—	—	30A	15A	—	—
SW3832D	✓	✓	✓	3PDT	ON	2-3 5-6 8-9	NONE	ON	2-1 5-4 8-7	—	—	30A	15A	—	—
SW3833D	✓	✓	✓	3PDT	ON	2-3 5-6 8-9	OFF	ON	2-1 5-4 8-7	—	—	30A	15A	—	—

Throw & Schematics:

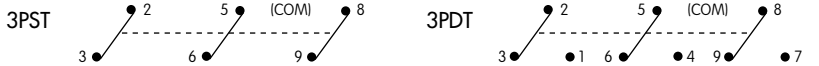

Note: Terminal numbers are actually on the switch.

\* UL/CUL & CSA for the following ratings: UL/CUL: 30A @ 30V DC, 15A @ 125V DC; CSA: 30A @ 30V DC, 15A @ 125V DC

\* UL, cULus & CSA recognized only when ordered with marking on switch (see General Specs)

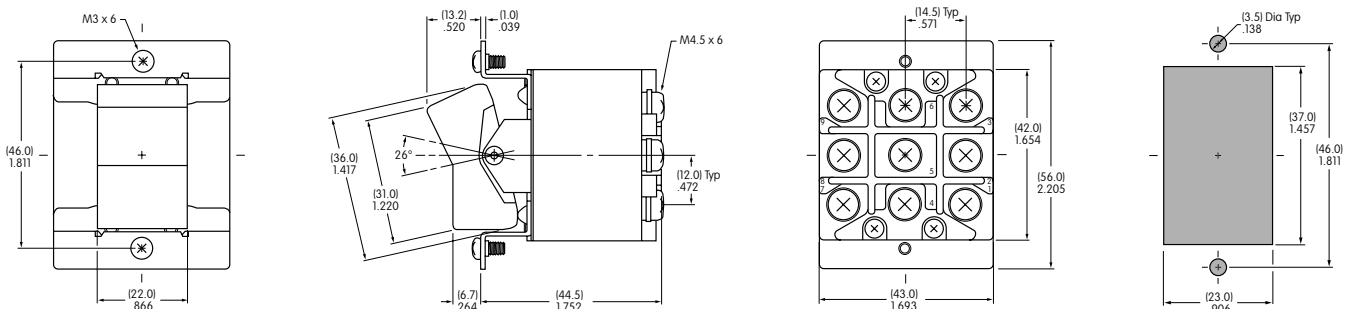

SW3831 & SW3831D do not have terminals 1, 4 & 7.

Maximum Effective Panel Thickness .177" (4.5mm)

Toggles  
 Rockers  
 Pushbuttons  
 Illuminated PB  
 Programmable  
 Keylocks  
 Rotaries  
 Slides  
 Tactiles  
 Tilt  
 Touch  
 Indicators  
 Accessories  
 Supplement