

# General Specifications

## Electrical Capacity (Resistive Load)

**Power Level (silver):** 6A @ 125V AC or 3A @ 250V AC or 6A @ 12V DC for silver  
**Logic Level (gold):** 0.4VA maximum @ 28V AC/DC maximum for gold  
 (Applicable Range 0.1mA ~ 0.1A @ 20mV ~ 28V)  
 Note: See Supplement Index for explanation of operating range.

## Other Ratings

**Contact Resistance:** 10 milliohms maximum for silver; 20 milliohms maximum for gold  
**Insulation Resistance:** 1,000 megohms minimum @ 500V DC  
**Dielectric Strength:** 1,000V AC minimum between contacts for 1 minute minimum;  
 1,500V AC minimum between contacts & case for 1 minute minimum  
**Mechanical Life:** 50,000 operations minimum  
**Electrical Life:** 25,000 operations minimum for silver; 50,000 operations minimum for gold  
**Static Capability:** Withstands 20 kilovolts ESD minimum  
**Nominal Operating Force:** 1.9N for .689" (17.5mm) toggle; 2.5N for .433" (11.0mm) toggle  
**Angle of Throw:** 25°

## Materials & Finishes

**Toggle:** Polycarbonate  
**Housing:** Glass fiber reinforced polyamide  
**Sealing Ring:** Nitrile butadiene rubber  
**Base:** Diallyl phthalate (UL94V-0)  
**Movable Contactor:** Phosphor bronze with silver or gold plating  
**Movable Contacts:** Silver alloy or copper with gold plating  
**Stationary Contact:** Silver plus copper with silver plating or copper with gold plating  
**Lamp Contacts:** Beryllium copper with silver plating  
**Power Terminals:** Copper with silver or gold plating  
**Lamp Terminals:** Brass with silver plating

## Environmental Data

**Operating Temperature Range:** -10°C through +55°C (+14°F through +131°F)  
**Humidity:** 90 ~ 95% humidity for 240 hours @ 40°C (104°F)  
**Vibration:** 10 ~ 55Hz with peak-to-peak amplitude of 1.5mm traversing the frequency range & returning in 1 minute; 3 right angled directions for 1.75 hours  
**Shock:** 50G (490m/s<sup>2</sup>) acceleration (tested in 6 right angled directions, with 5 shocks in each direction)

## Installation

**Mounting Torque:** .98Nm (8.67 lb•in) maximum  
**Soldering Time & Temperature:** Manual Soldering: See Profile B in Supplement section.

## Standards & Certifications

**Flammability Standards:** UL94V-0 base

# Distinctive Characteristics

Choice of long or short toggles in translucent colors combine with bright LEDs available in red, amber, and green, plus super bright LEDs available in white, green, and blue.

Black face nut enhances front panel appearance.

Antistatic material used for toggle withstands 20 kilovolts electrostatic discharge.

Panel seal, achieved with use of optional exterior o-ring, conforms to IP65 of IEC60529 Standards.

Interior o-ring protects contacts from oil, dust, water, and other contaminants.

UL94V-0 flammability rated for base.

High insulating barriers protect against crossover.

Terminals are molded in and epoxy sealed to lock out flux, dust, and other contaminants.

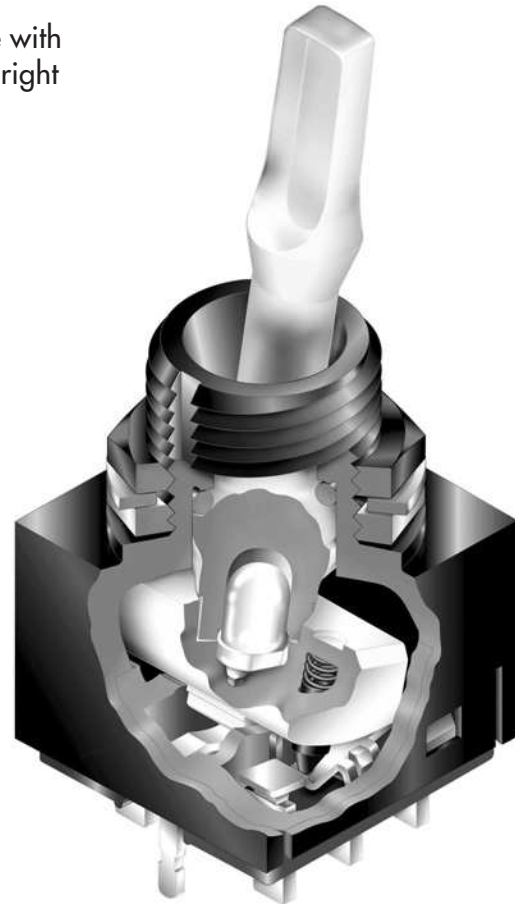

Actual Size



A  
Toggles

Rockers

Pushbuttons

Illuminated PB

Programmable

Keylocks

Rotaries

Slides

Tactiles

Tilt

Touch

Indicators

Accessories

Supplement

### TYPICAL SWITCH ORDERING EXAMPLE

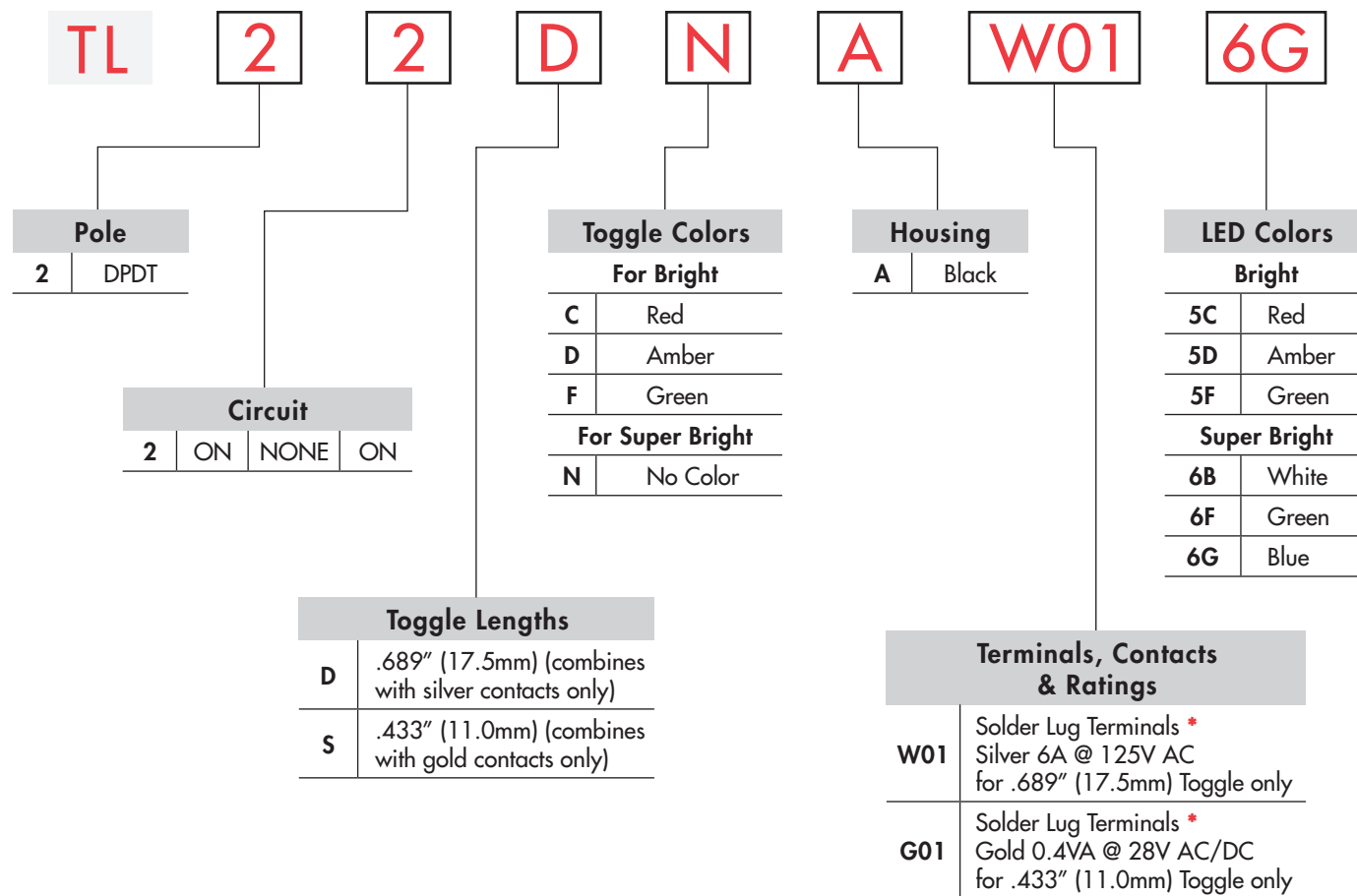





\* Wire harness & cable assemblies offered only in Americas

### DESCRIPTION FOR TYPICAL ORDERING EXAMPLE

#### TL22DNAW016G

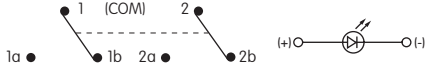

## POLE & CIRCUIT

		Toggle Position			Connected Terminals			Throw & Power/Lamp Schematics
Pole	Model	Down 	Center	Up 	Down 	Center	Up 	Notes: Terminal numbers are not actually on switch. Lamp circuit is isolated and requires an external power source.
DP	TL22	ON	NONE	ON	1-1b 2-2b	OPEN	1-1a 2-2a	DPDT 

## TOGGLE LENGTHS & COLORS

**D** .689"  
(17.5mm)

Combines with Silver Contacts only

Material: Polycarbonate

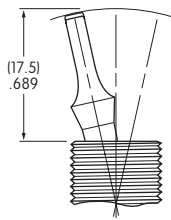

**S** .433"  
(11.0mm)

Combines with Gold Contacts only

Material: Polycarbonate

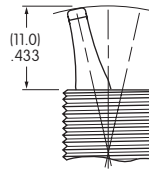

Colors Available for Bright LED

**C** Red **D** Amber **F** Green

Color Available for Super Bright LED

**N** No Color (Appearance is matte finish of clear material)

## HOUSING

**A** Black

The housing consists of the one-piece bushing/case of glass fiber reinforced polyamide in black color only.

The diallyl phthalate material used for the base is UL flammability rated 94V-0; housing material is not.

## CONTACT MATERIALS, RATINGS, & TERMINALS

**W**

**Silver Contacts Power Level**  
6A @ 125V AC & 3A @ 250V AC  
& 6A @ 12V DC

**01**

**Solder Lug Terminals**

**G**

**Gold Contacts Logic Level**  
0.4VA maximum @ 28V AC/DC

See Supplement Index for complete explanation of operating range.

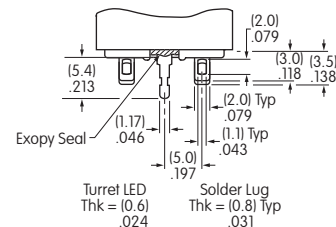

## LED CODES & SPECIFICATIONS

Electrical specifications are determined at a basic temperature of 25°C. Lamp circuit is independent of switch operation.

If the source voltage is greater than rated voltage, a ballast resistor is required.

The ballast resistor calculation and more lamp detail are shown in Supplement section.

Super Bright LEDs are Electrostatic Sensitive		Colored Toggles			Clear Toggles		
		<b>5</b> Bright			<b>6</b> Super Bright		
LED Factory Assembled Not Available Separately	Color	<b>C</b> Red	<b>D</b> Amber	<b>F</b> Green	<b>B</b> White	<b>F</b> Green	<b>G</b> Blue
Forward Peak Current	$I_{FM}$	30mA	30mA	50mA	30mA	30mA	30mA
Typical Forward Current	$I_F$	20mA	20mA	20mA	20mA	20mA	20mA
Forward Voltage	$V_F$	2.0V	2.1V	2.27V	3.6V	3.5V	3.6V
Reverse Peak Voltage	$V_{RM}$	4V	4V	4V	5V	5V	5V
Current Reduction Rate Above 25°C	$\Delta I_F$	0.32mA/°C	0.32mA/°C	0.50mA/°C	0.50mA/°C	0.50mA/°C	0.50mA/°C
Ambient Temperature Range		-10°C ~ +55°C			-10°C ~ +55°C		

## TYPICAL SWITCH DIMENSIONS

### 17.5mm Toggle

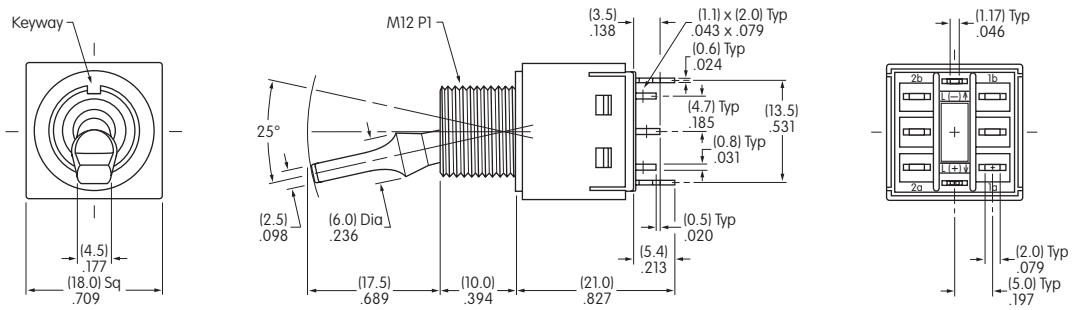

**TL22DNAW016G**

### 11.0mm Toggle

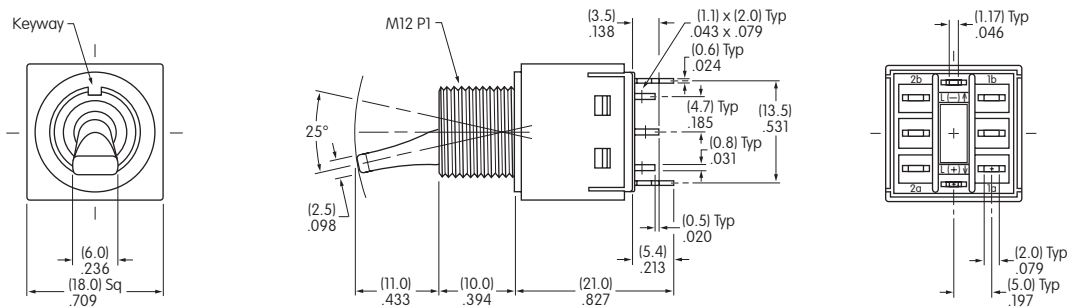

**TL22SCAG015C**

## STANDARD HARDWARE

## OPTIONAL HARDWARE

**AT527MA Black Hex Nut**  
Use as Face Nut  
Chrome/Steel

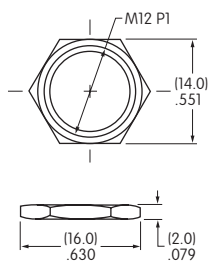

**AT527M Hex Nut**  
Use as Backup Nut  
Nickel/Steel

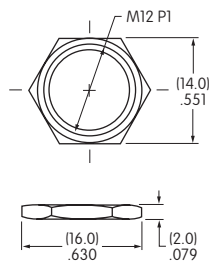

**AT508 Lockwasher**  
Not to use with Panel Seal  
Steel with Chromate/Zinc

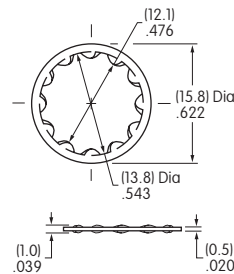

**AT401P O-ring**  
Use for Panel Seal  
Nitrile butadiene rubber

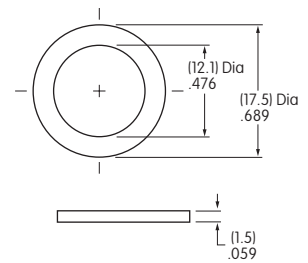

Hardware details in Accessories & Hardware section.

## Panel Cutouts

Maximum Panel Thickness  
with Standard Hardware  
.157" (4.0mm)

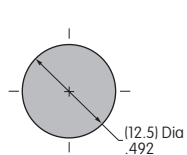

Maximum Panel Thickness  
with Standard Hardware  
& AT401P O-ring  
.236" (6.0mm)

