

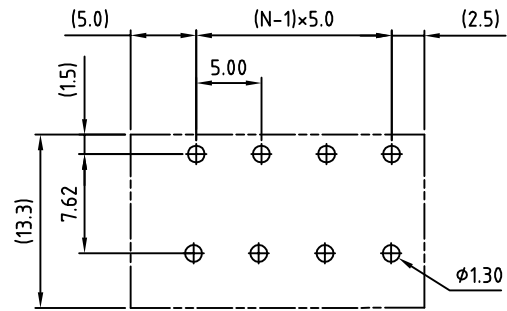

SIGN	DATE	DESCRIPTION	APPROVER
<i>THIS IS CAD DRAWING, DO NOT REVISE MANUALLY!!!</i>			

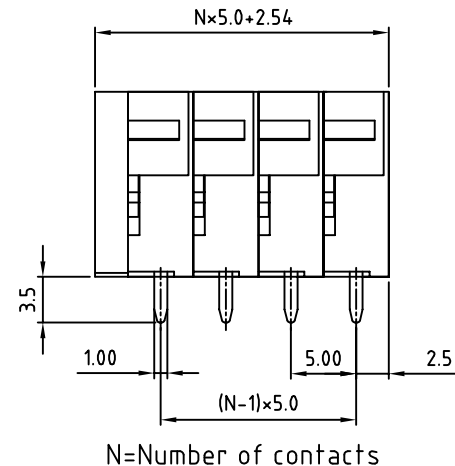
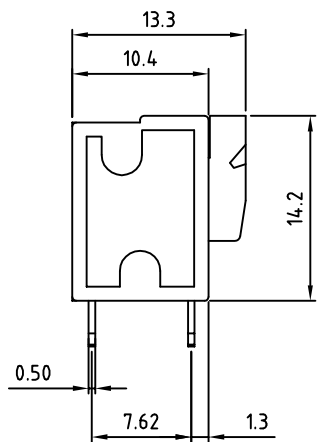
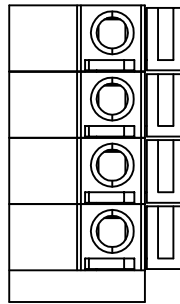

P.C.B. LAYOUT

- Material**
- Terminal body (Contact pin): Brass
 - Wire guard: Stainless steel
 - Surface of solder tail: Tin plated
 - Insulator (housing): Thermoplastic (UL94V-0)
- Electrical** cULus/VDE
- Voltage rating: 300VAC/250VAC
 - Current rating: 10A/10A
 - Wire range: 0.75-1.5mm²
Solid wire(AWG): 14-24
Stranded wire(AWG): 14-24
 - Wire strip length: 6-7mm
 - Withstanding Voltage: 1.6KV/2KV
 - Operating temperature: -30°C to +105°C
 - Soldering temperature: 250°C±10°C/5 Sec
 - Safety Approval:  

RoHS Compliant

PART NUMBER:

OSTHAXX3050

No. of Poles	COLOR
02 2 Poles	2: Red
03 3 Poles	3: Orange
... ..	5: Green (Standard)
24 24 Poles	6: Grey

THESE DRAWINGS AND SPECIFICATIONS ARE THE PROPERTY OF ON-SHORE TECHNOLOGY, INC. AND SHALL NOT BE REPRODUCED, COPIED OR USED IN ANY MANNER WITHOUT THE PRIOR WRITTEN CONSENT OF ON-SHORE TECHNOLOGY, INC.



TITLE		OSTHA-5.0mm Vertical (90° wire inlet)			
PART NO.	OSTHAXX3050	DWG NO.	OSTHAXX3050.DWG		
APPROVED	CHECKED	DESIGNED	DRAWN	CUST NO.	Tolerance
Shi Jun 2006.11.01	Marvin 2006.11.01	Steady 2006.10.11	Steady 2006.10.11		X. ±0.50 X.X ±0.30 X.XX ±0.10 X° ±1°
SHEET: 01/01				UNIT: mm	SCALE: NONE
				REV.: D	