

THIS DOCUMENT CONTAINS DATA PROPRIETARY TO PROJECTS UNLIMITED, INC. ANY USE OR REPRODUCTION OF THIS DOCUMENT WITHOUT WRITTEN PERMISSION OF PROJECTS UNLIMITED, INC. IS PROHIBITED.
 ©2006, Projects Unlimited Inc.

SPECIFICATIONS

PARAMETERS	VALUES	UNITS
RATED VOLTAGE	24	Vdc
OPERATING VOLTAGE RANGE	9 ~ 28	Vdc
RATED CURRENT (MAX)	6	mA
INGRESS PROTECTION	IP42	-
COLOR	RED	-
OPERATING TEMPERATURE	-10 ~ +55	°C
HOUSING MATERIAL	ABS	-
TERMINAL MATERIAL	SCREW	-
WEIGHT	100	grams
FLASH RATE	0.5/1	Hz

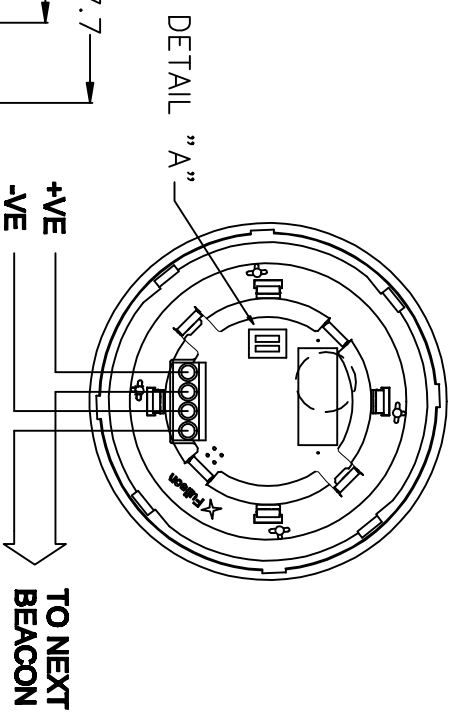
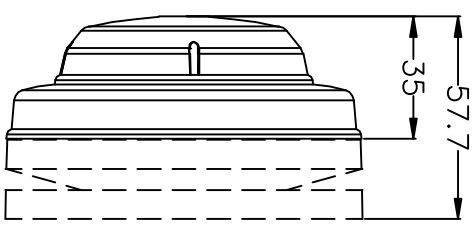
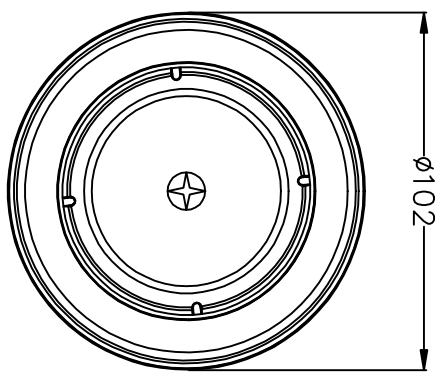
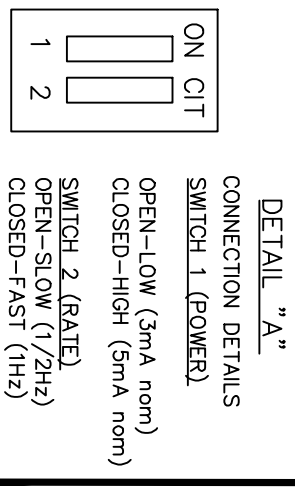

REVISIONS

LTR	DESCRIPTION	DATE	APPROVED
-	RELEASED FROM ENGINEERING	9/7/06	
A	ADDED BASE NOTE NEW DIMENSION	5/21/07	R.W.
B	REVISED DETAIL "A" DIL SWITCH	3/11/09	B.R.

NOTES:

1. ALL DIMENSIONS ARE IN MILLIMETERS.
2. SPECIFICATION SUBJECT TO CHANGE OR WITHDRAWAL WITHOUT NOTICE.
3. THIS PART IS ROHS 2002/95/EC COMPLIANT.
4. MOUNTS TO AW-05MR OR AW-05MW-NC.

FILE NAME
 VW-05MR-RL.DWG

UNLESS OTHERWISE SPECIFIED:
 DIMENSIONS OF ALL PARTS IN MILLIMETERS. TOLERANCES ARE ±0.5 AND ANGLES ARE ±3°.

APPROVALS	DATE
DRAWN JD.	9/06
CHECKED R.W.	9/06
APPROVED B.R.	9/06

DO NOT SCALE DRAWING

projects unlimited
 Dayton, Ohio

SIREN

DRAWING NO. VW-05MR-RL

SCALE: N.T.S. SHEET 1 OF 1