

## SPECIFICATION

- Part No. : **FW.92.RNT.M**
- Product Name : Penta-band cellular 2G/3G  
GSM/CDMA/UMTS  
Flexible Whip Monopole Antenna  
850/900/1800/1900/2100 MHz
- Feature : IP67  
Robust Inner Steel Core  
RP-N-type Male Connector  
RoHS Compliant✓



## 1. Introduction

The FW.92 is a flexible cellular whip antenna with IP67 housing and an RP-N-type male connector. It has a wide response and high peak gain. It is ideal for outdoor environments which require high gain on both lower and upper bands. Its unique characteristic is it has stable above 3dBi peak gain on all five common 2G/3G GSM/CDMA cellular bands used worldwide (when attached to a 30cm\*30cm metal plate). The antenna radiates best attached to a metal plate but it can still perform without as evidenced by the table below.

This antenna delivers wider coverage areas and more reliable connections for professional customers in the automotive and industrial sectors. The whip is made up of a flexible inner steel core covered by TPU so extremely resistant to collisions and maintaining its original shape and RF performance.

Customized frequency and gain versions can be supplied.

## 2. Specification

CELLULAR					
Frequency (MHz)	824~896	880~960	1710~1880	1850~1990	1710~2170
Peak Gain (dBi)					
Free Space	-0.2	-0.1	3.0	3.3	3.3
With Ground plane(30x30cm)	3.3	3.4	3.9	4.0	4.0
Average Gain (dBi)					
Free Space	-3.8	-3.4	-2.3	-1.9	-1.9
With Ground plane(30x30cm)	-1.2	-2.1	-2.0	-1.5	-1.4
Efficiency					
Free Space	41%	46%	59%	65%	65%
With Ground plane(30x30cm)	70%	61%	63%	71%	72%
Impedance	50Ω				
Polarization	Linear				
Radiation Pattern	Omni				
Input Power	50 W				
MECHANICAL					
Dimensions	Height 274 ± 5 mm				
Base Diameter	20 ± 0.1 mm				
Whip Diameter	4 ± 0.2 mm				
Casing	ABS				
Connector	RP-N-type Male				
ENVIRONMENTAL					
Temperature Range	-40°C to 85°C				
Humidity	Non-condensing 65°C 95% RH				

### 3. Antenna Characteristics

#### 3.1. Return Loss

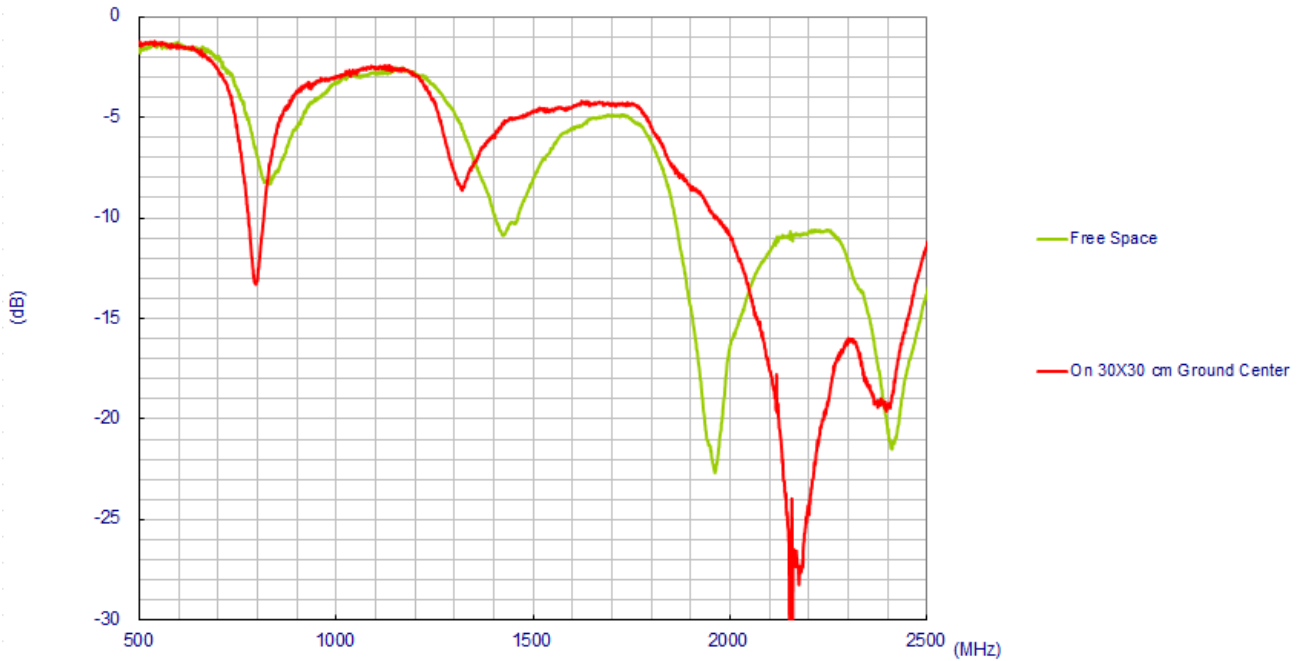

#### 3.2. Antenna Efficiency

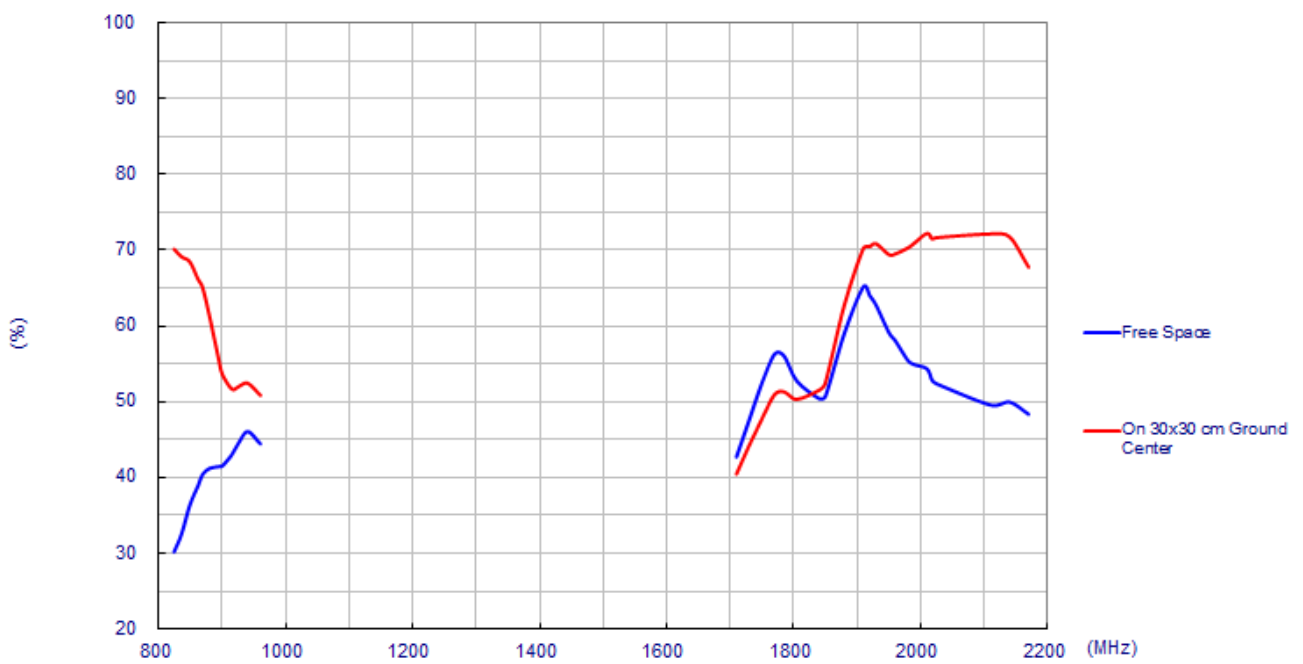

### 3.3. Peak Gain

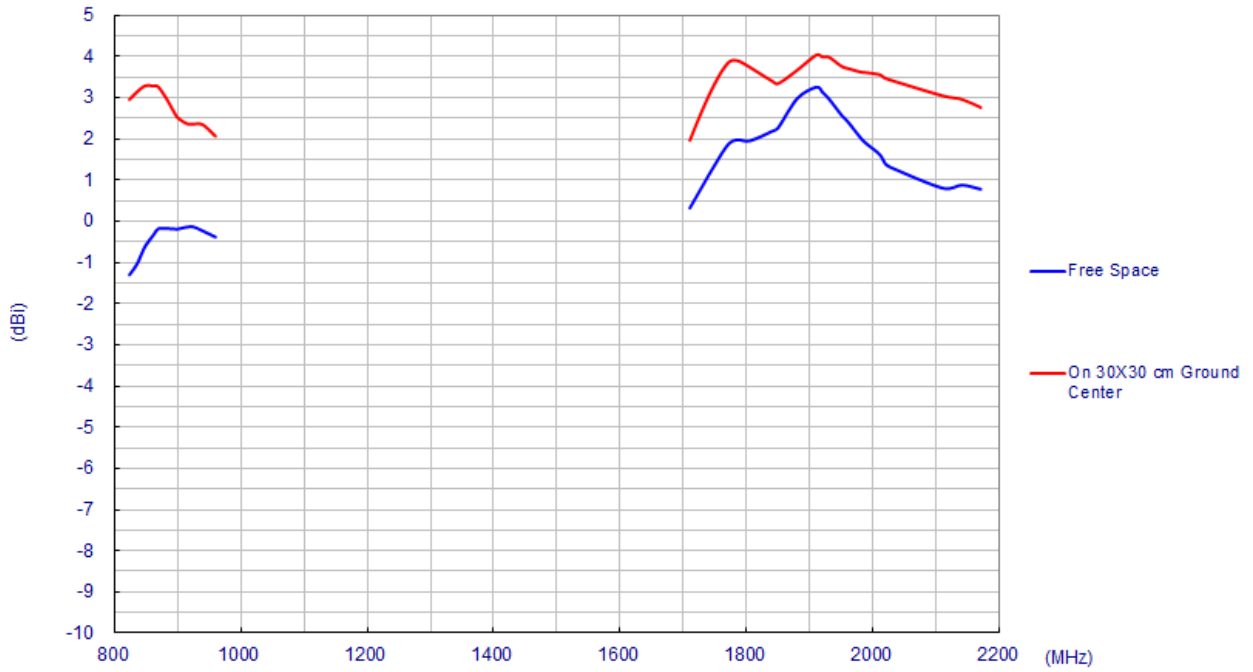

### 3.4. Average Gain

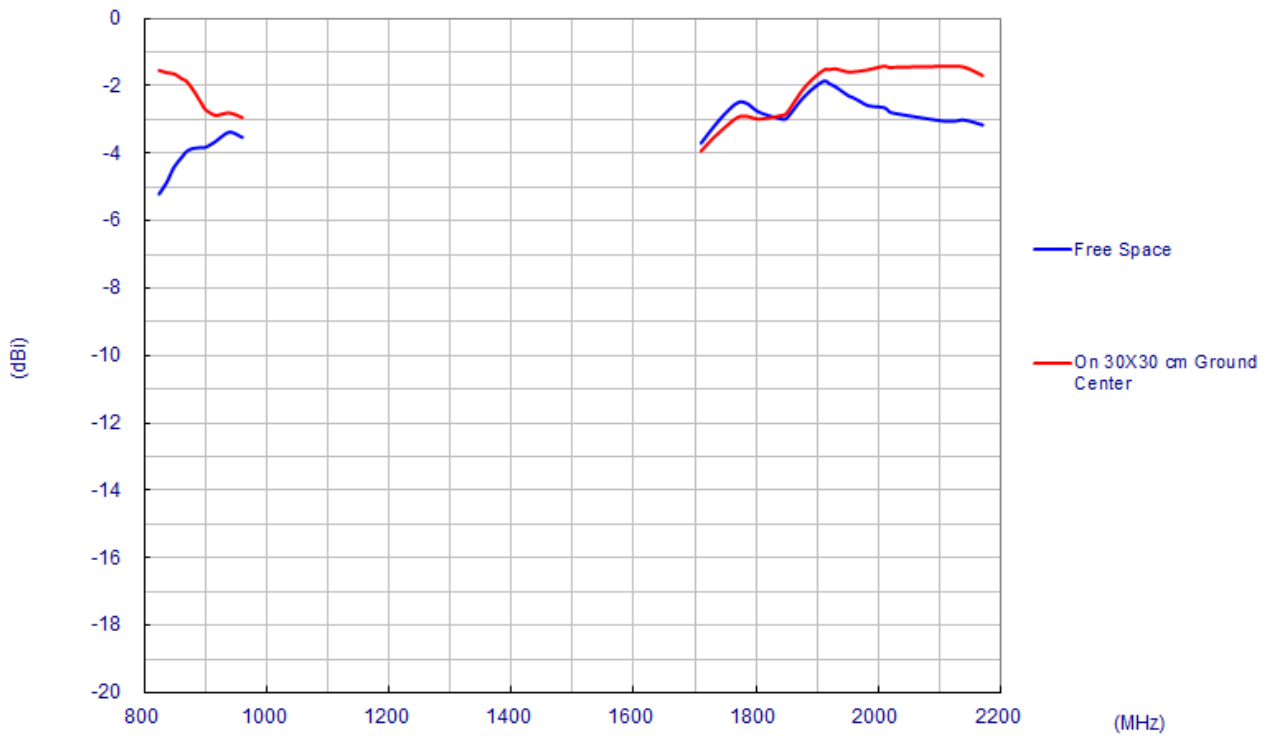

## 4. Antenna Radiation Pattern

### 4.1. Antenna Free Space

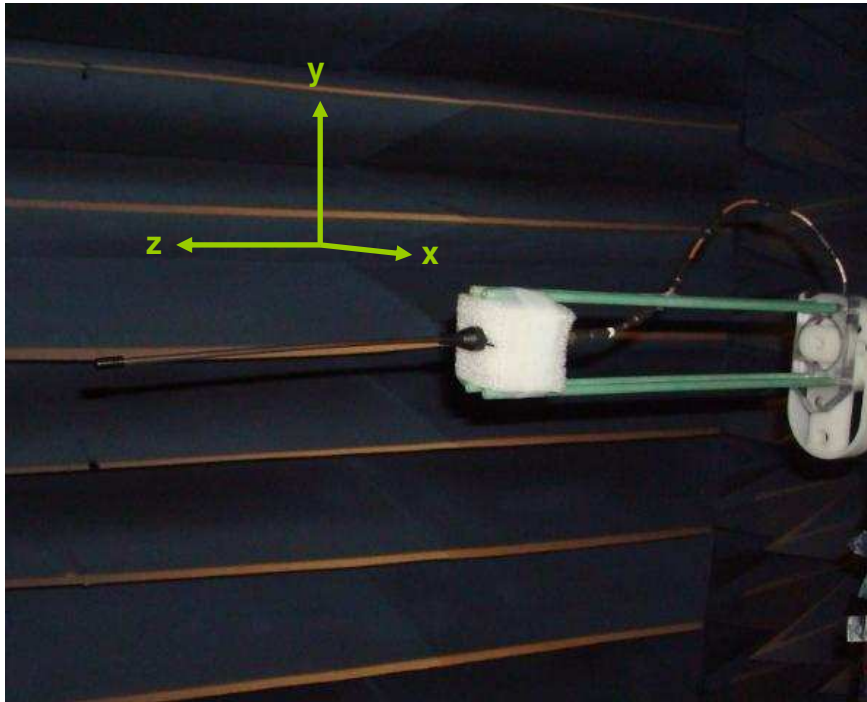

### 4.1.1 XY-plane

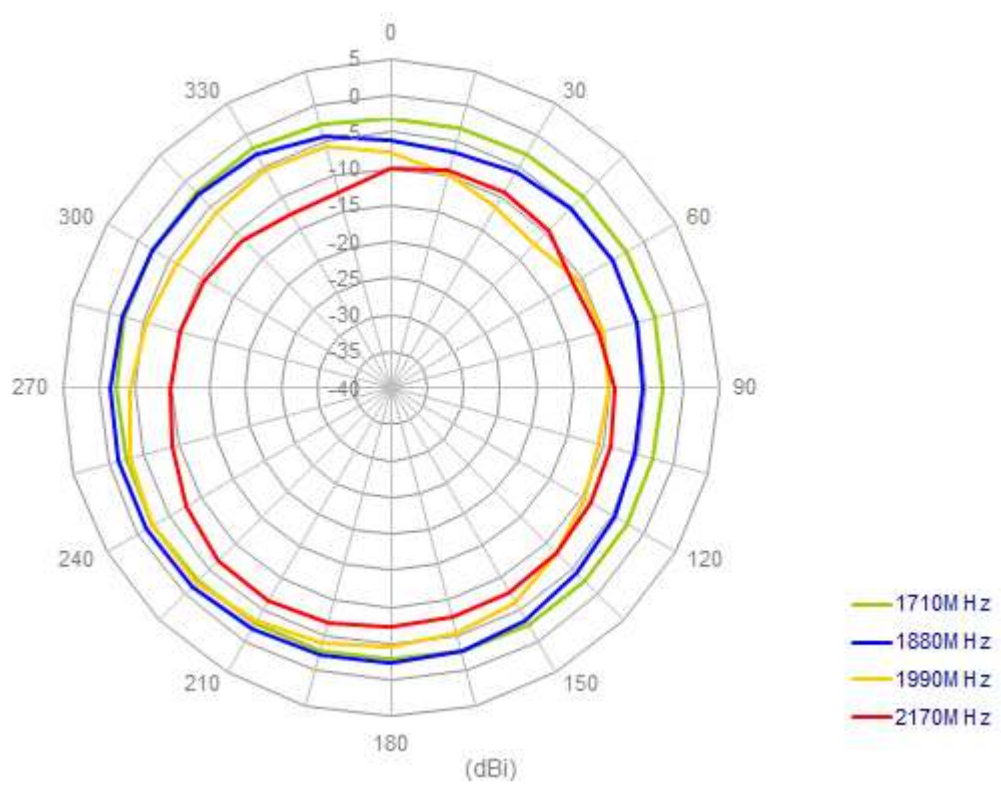
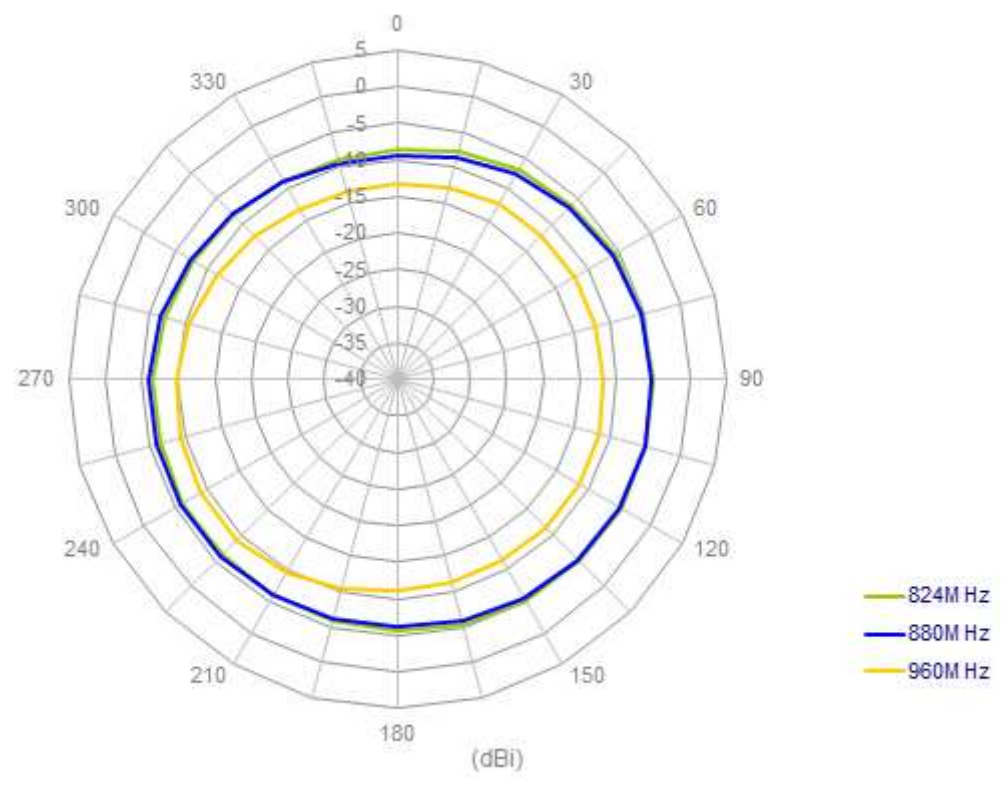

### 4.1.2 XZ-plane

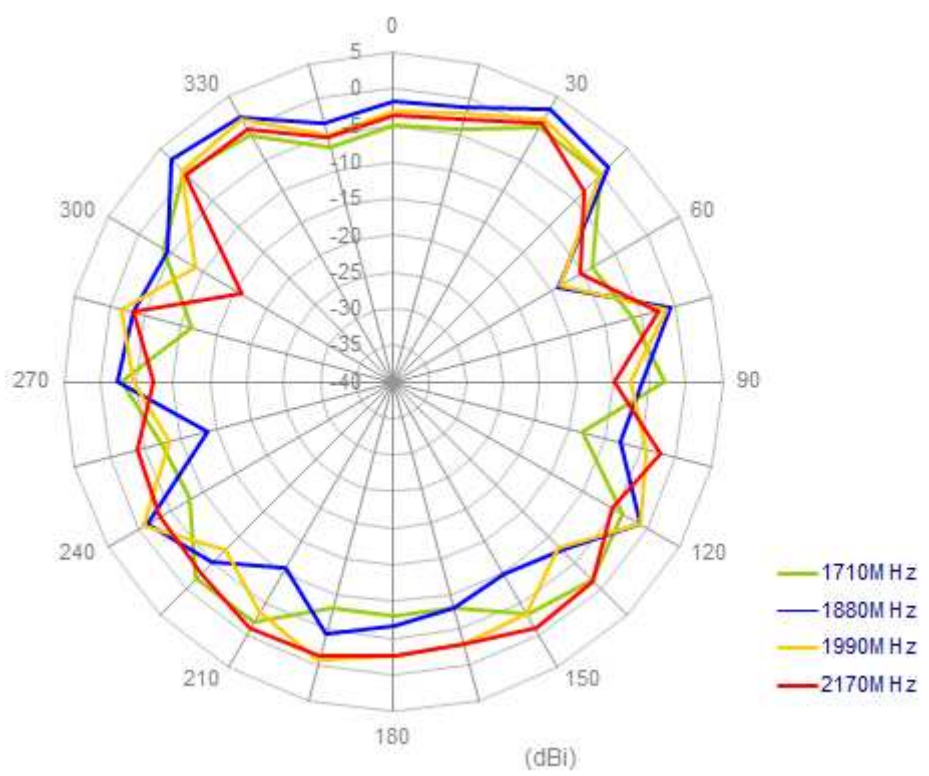
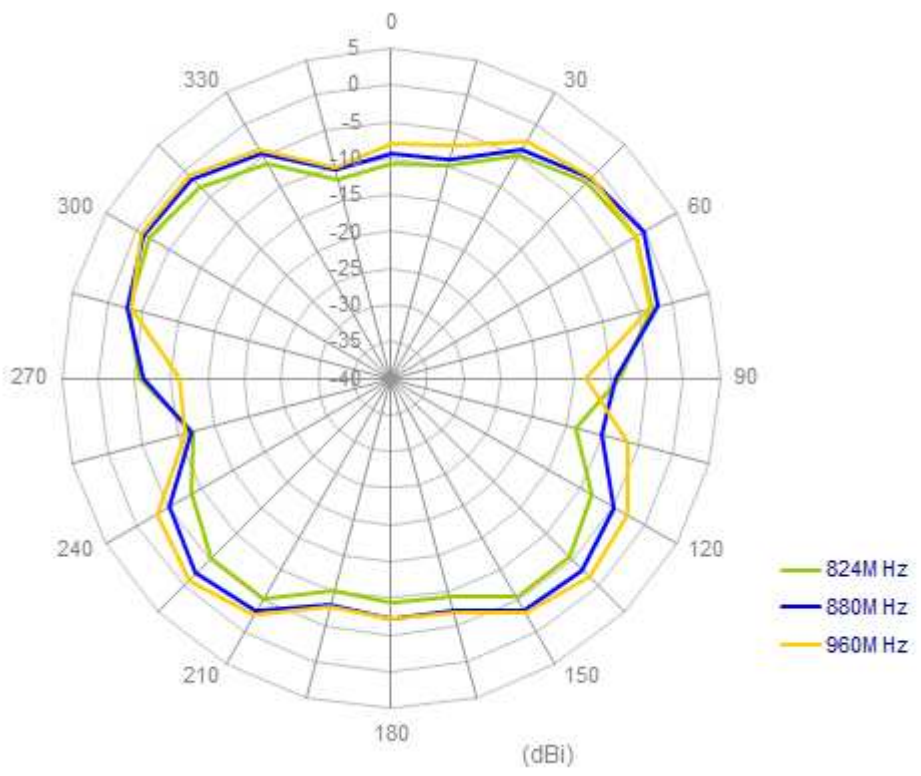



#### 4.2. Antenna on Ground plane (30X30cm)

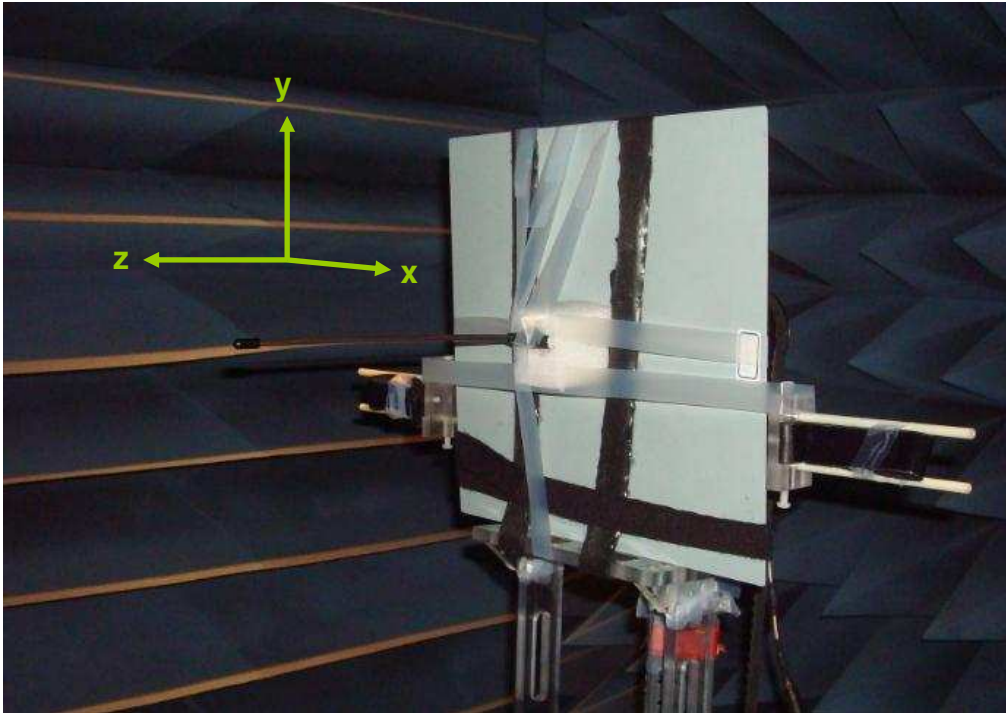

### 4.2.1 XY-plane

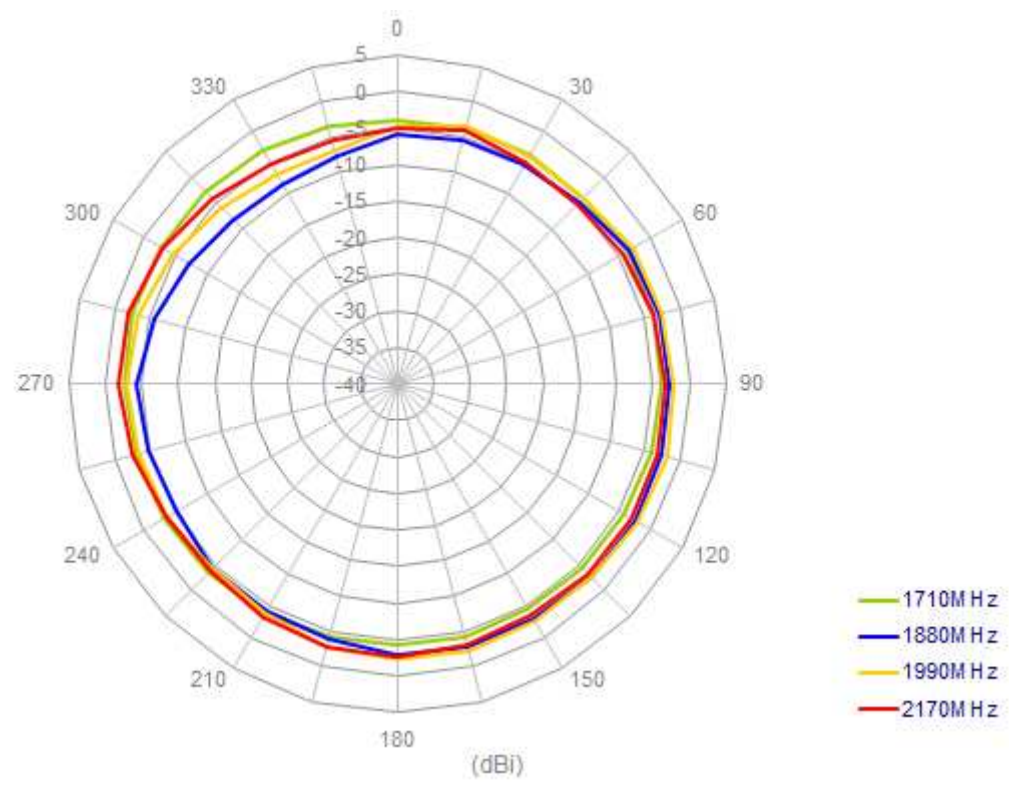
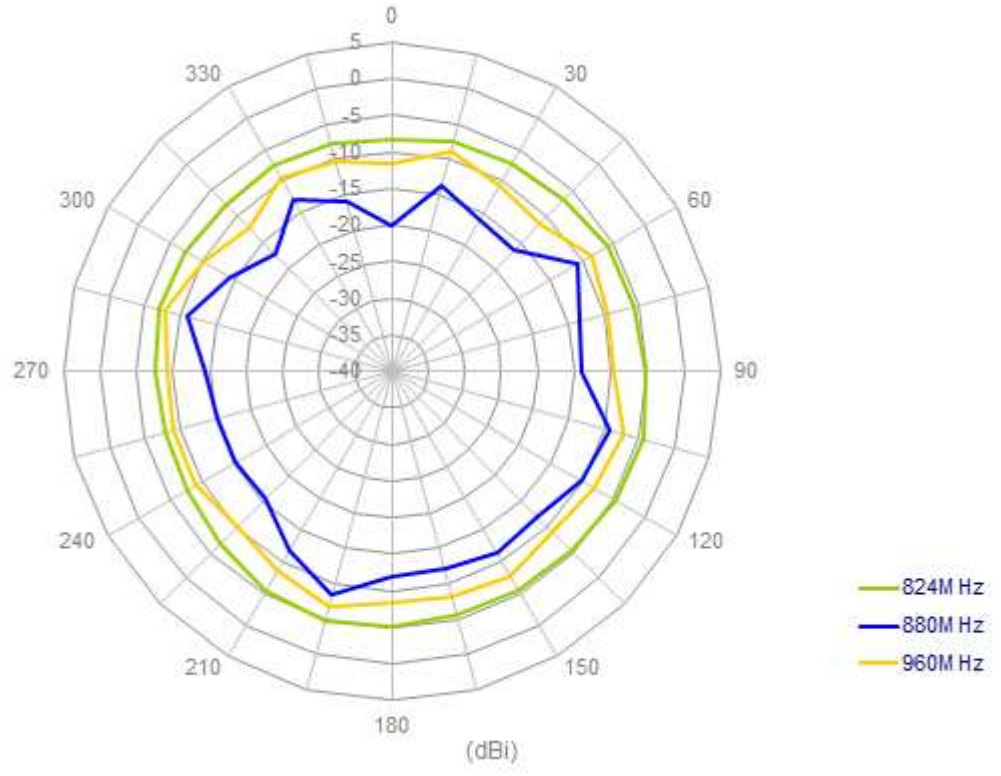

### 4.2.2 XZ-plane

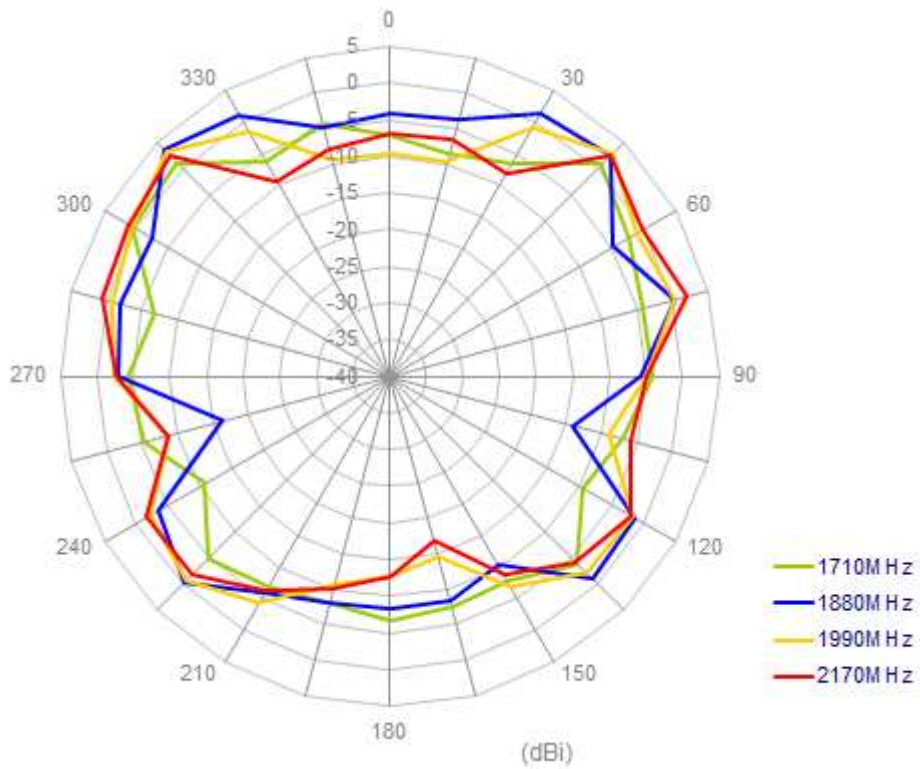
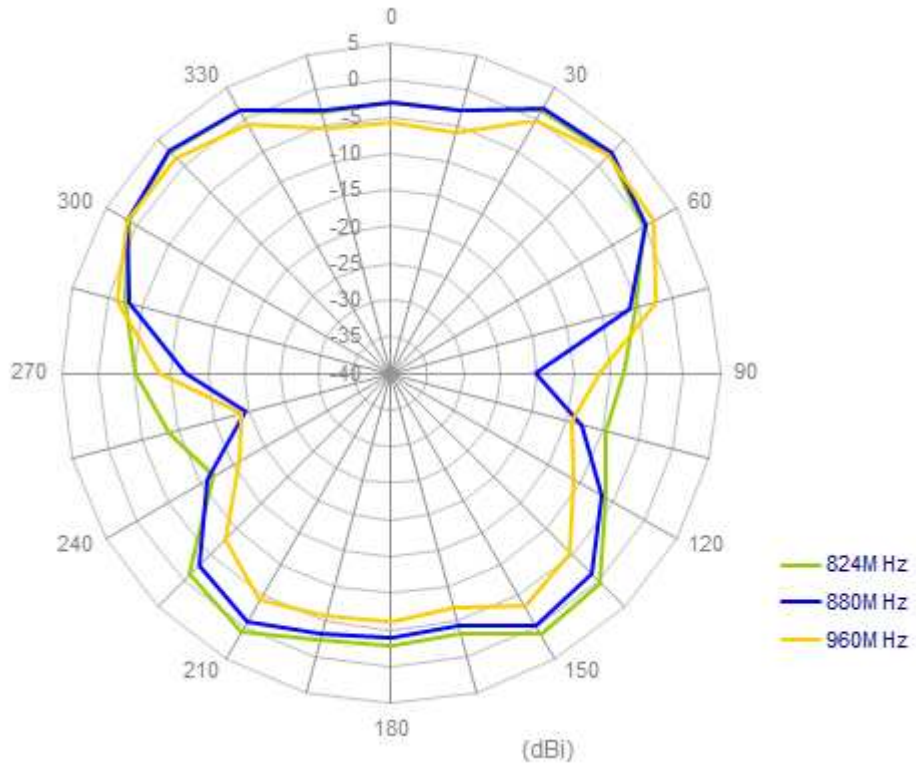

## 5. Antenna Drawing

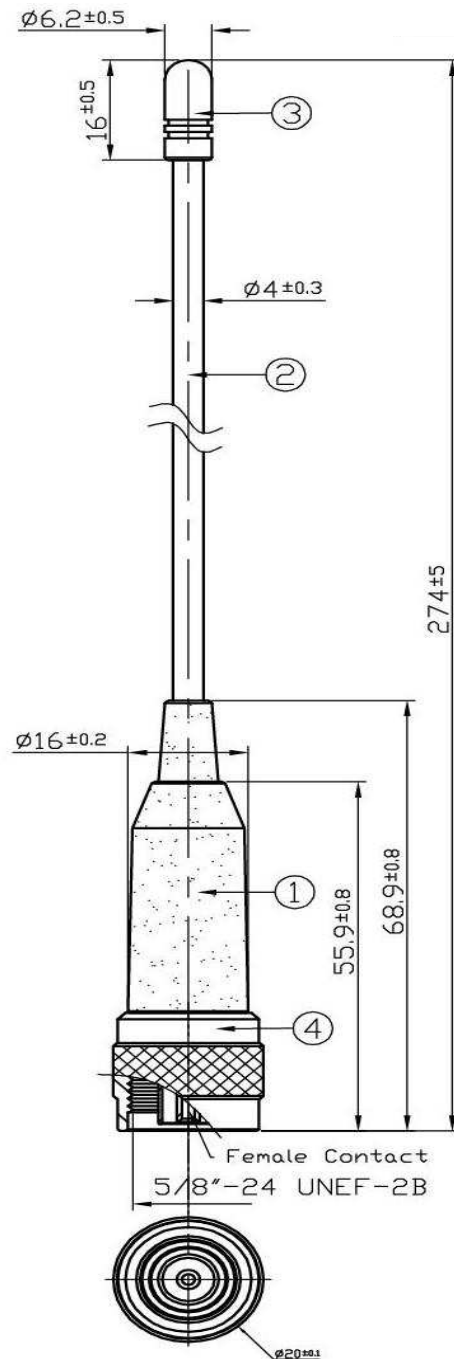

	Name	P/N	Material	Finish	QTY
①	Housing	000111K0600XXA	ABS	Black	1
②	Flexible Whip	001111K0000XXA	Steel+PE Jacket	Black	1
③	Cap	000711C0000XXA	ABS	Black	1
④	NTYPE(M)RP ST	211011K000002A	Brass	Black	1



## 6. Packaging

