

SPECIFICATION

Part No. : **TI.19.2113**

Product Name : 2dBi 915MHz ISM Band Dipole Terminal
Antenna, SMA(M) Hinge

Feature : High efficiency dipole terminal antenna
ROHS compliant



1. Introduction

TI.19 is a high performance 915MHz ISM band dipole omni-directional antenna. The hinged design enables the antenna to be positioned at its most suitable angle. This antenna features a SMA(M) Plug Connector.

For a lot of antenna applications, such as Wi-Fi Hotspot or cellular Pico-cell, the antenna of the operator’s device and the antenna of the user’s remote device are not on the same horizontal level. The TI.19 has been designed with a butterfly shape radiation pattern, to help counteract this effect.

2. Specification

ELECTRICAL	
Frequency	902 ~ 928MHz
Peak Gain (bend)	2.5dBi
Peak Gain (straight)	2.4dBi
Average Gain (bend)	-1.0dBi
Average Gain (straight)	-0.9dBi
Efficiency (bend)	81%
Efficiency (straight)	82%
Impedance	50Ω
VSWR	< 1.9 : 1
Polarization	Linear
Radiation Pattern	Omni
Input Power	10 W
MECHANICAL	
Antenna Length	389 ± 5 mm
Antenna Diameter	13 ± 0.5 mm
Casing	TPU
Connector	SMA Male
ENVIRONMENTAL	
Temperature Range	-40°C to 85°C
Humidity	Non-condensing 65°C 95% RH

3. Antenna S11 Properties

3.1 Return Loss

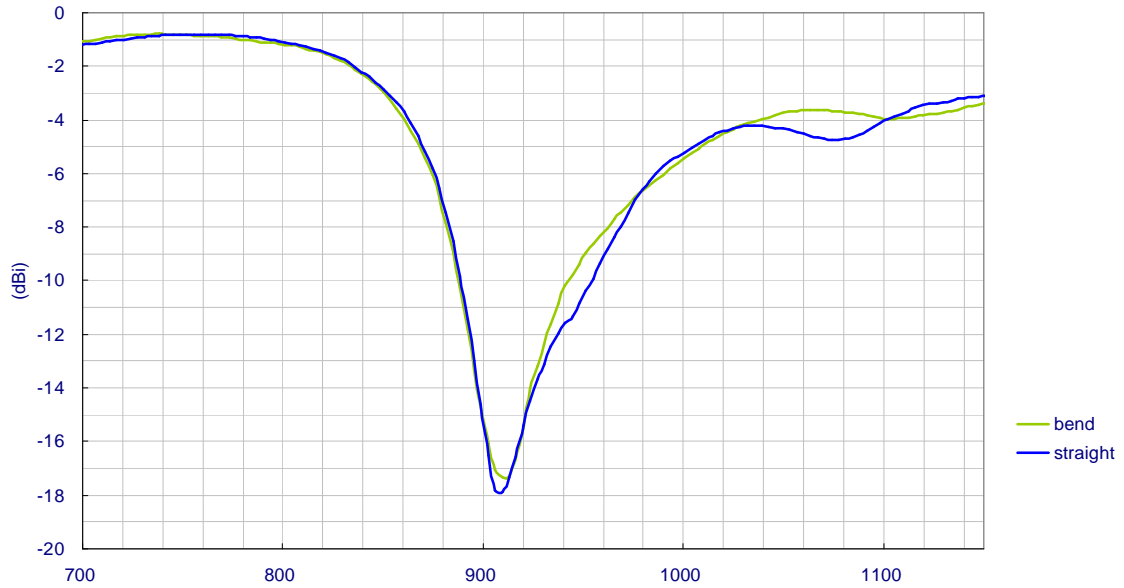

3.2 VSWR

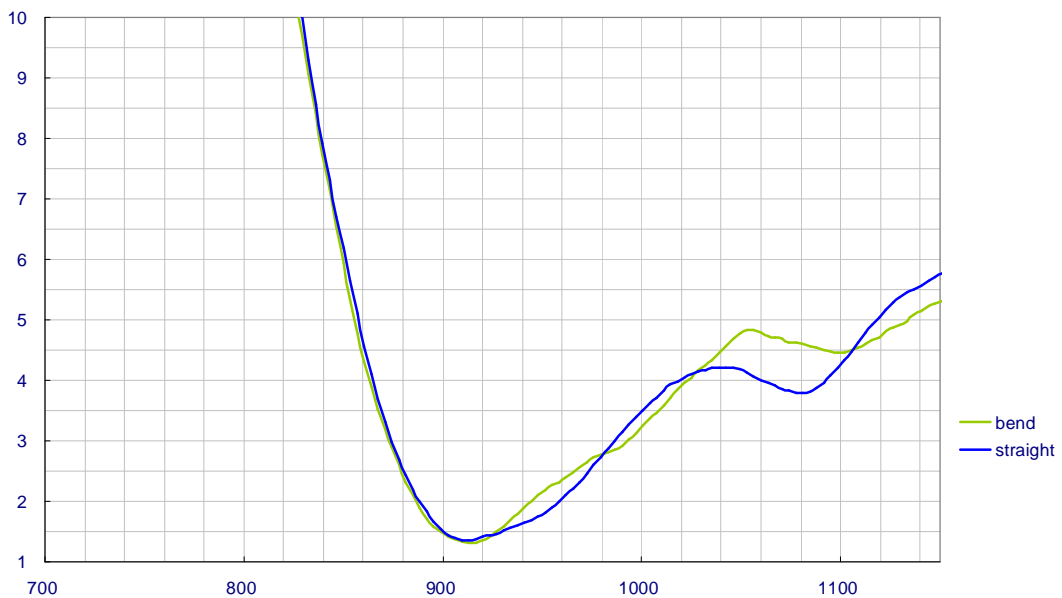

4. Antenna Radiation Properties

4.1. 3D Radiation Efficiency

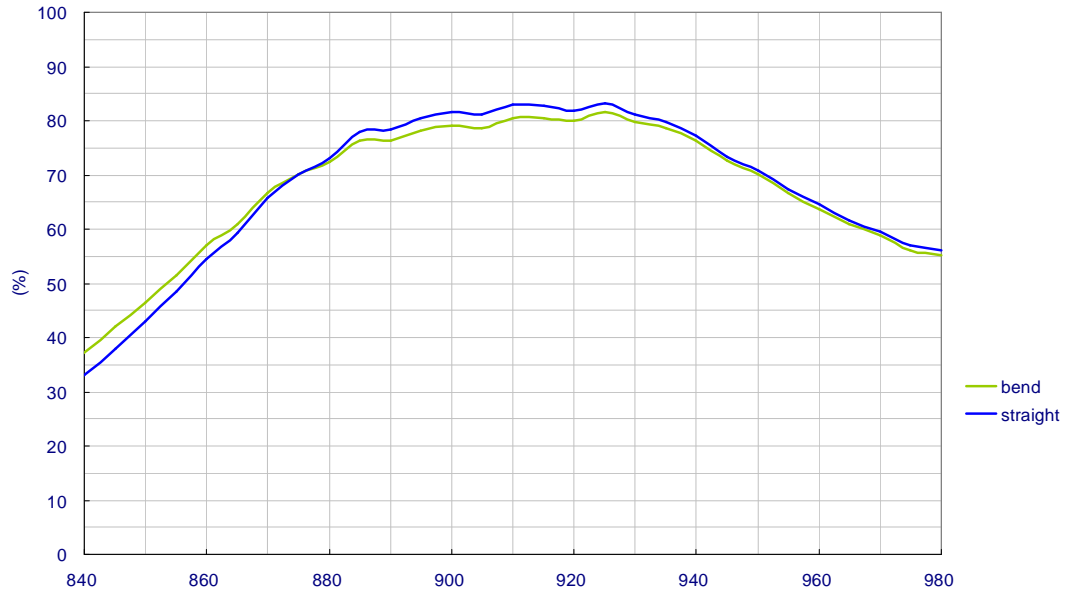

4.2. Peak Gain

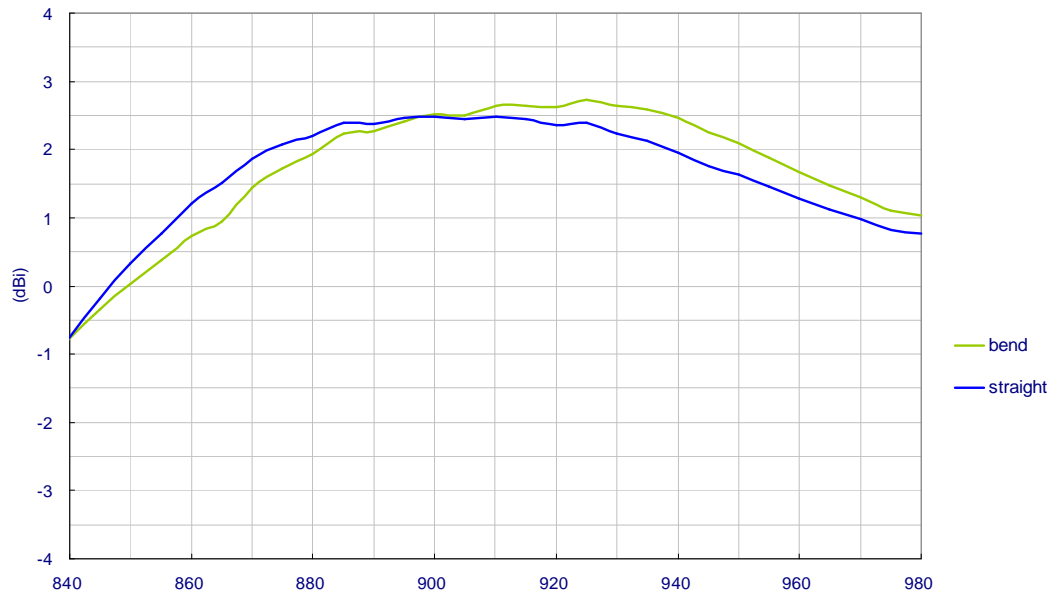

4.3. Average Gain

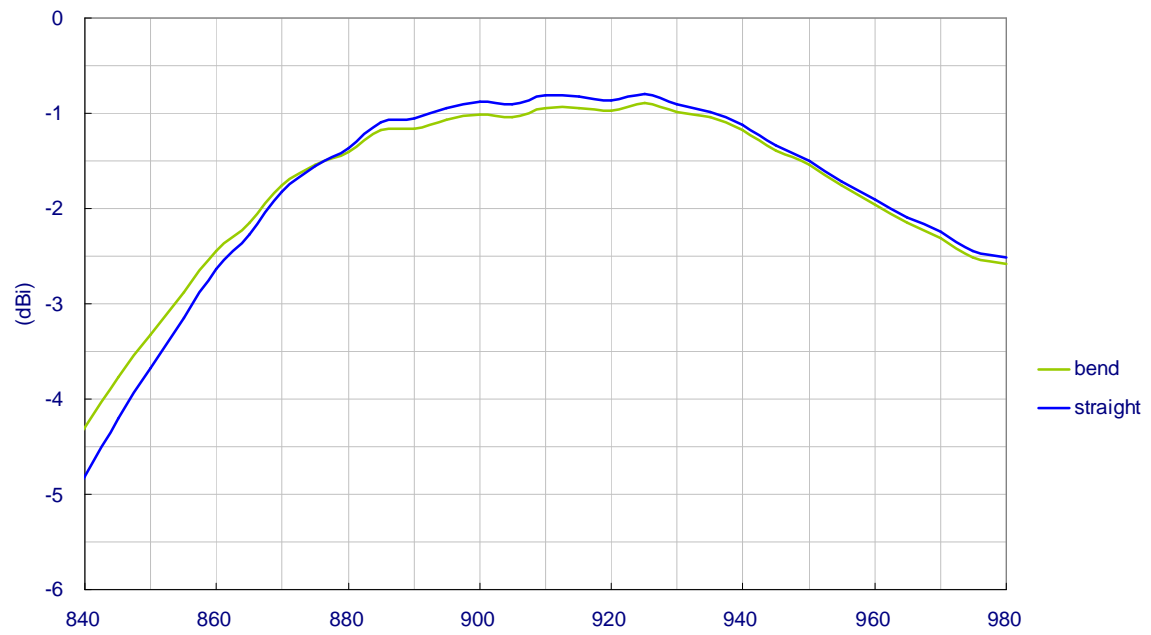

4.4. Radiation Pattern of 90 Degree Bend Position

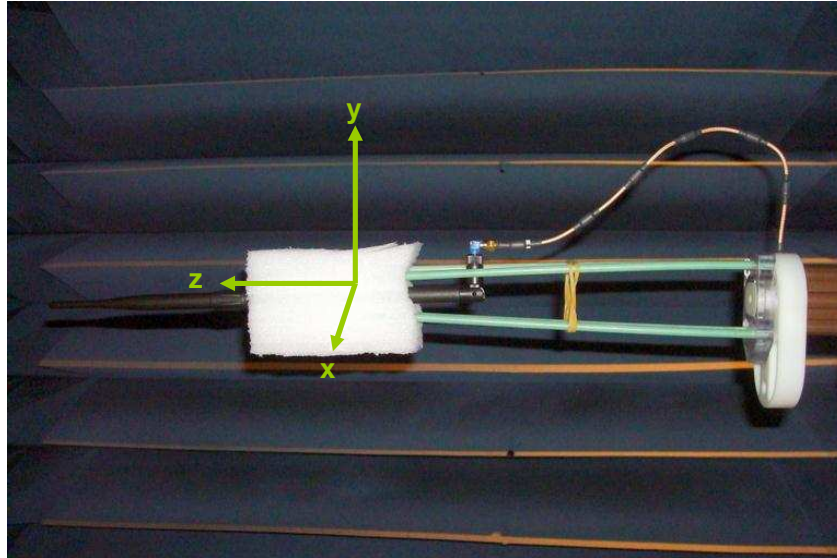

4.4.1 3D Radiation Pattern

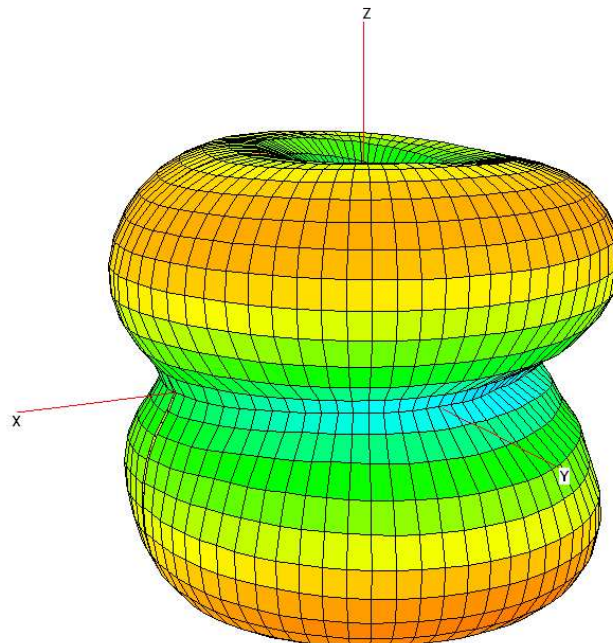

4.4.2 X-Z Plane Radiation

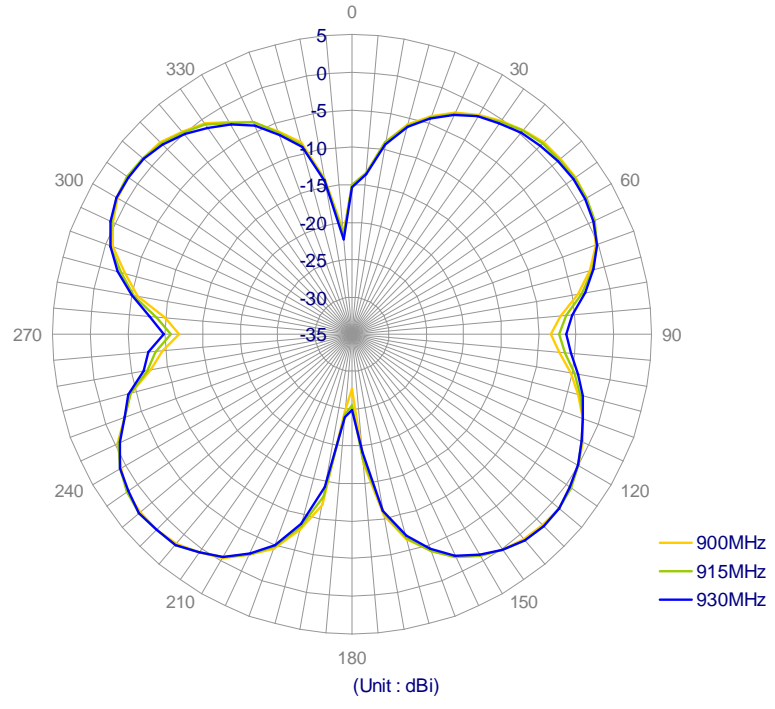

4.4.3 X-Y Plane Radiation

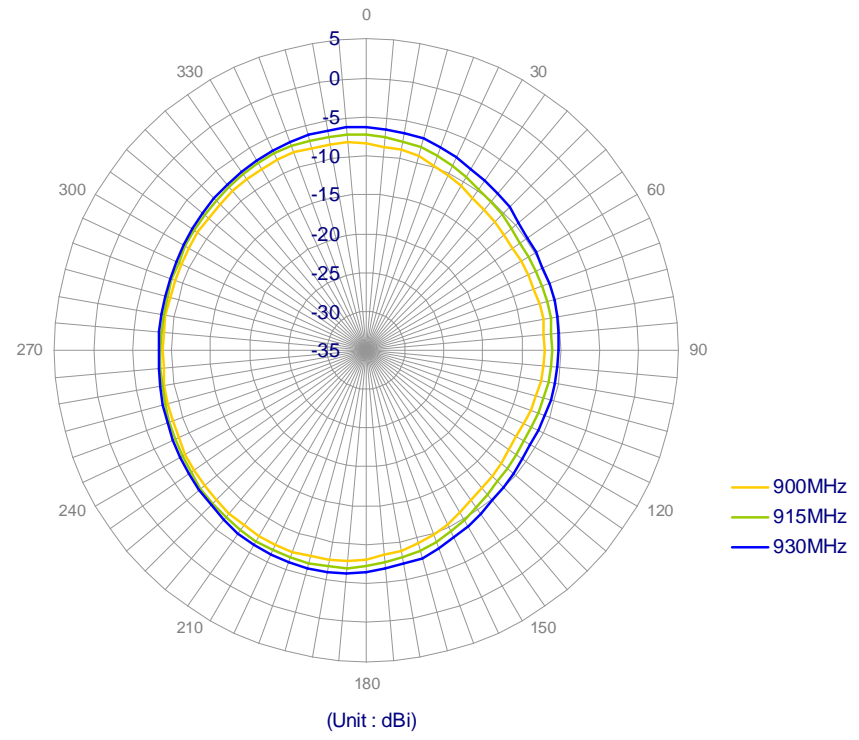

4.4.4 Radiation at 45 Degree from XY Plane

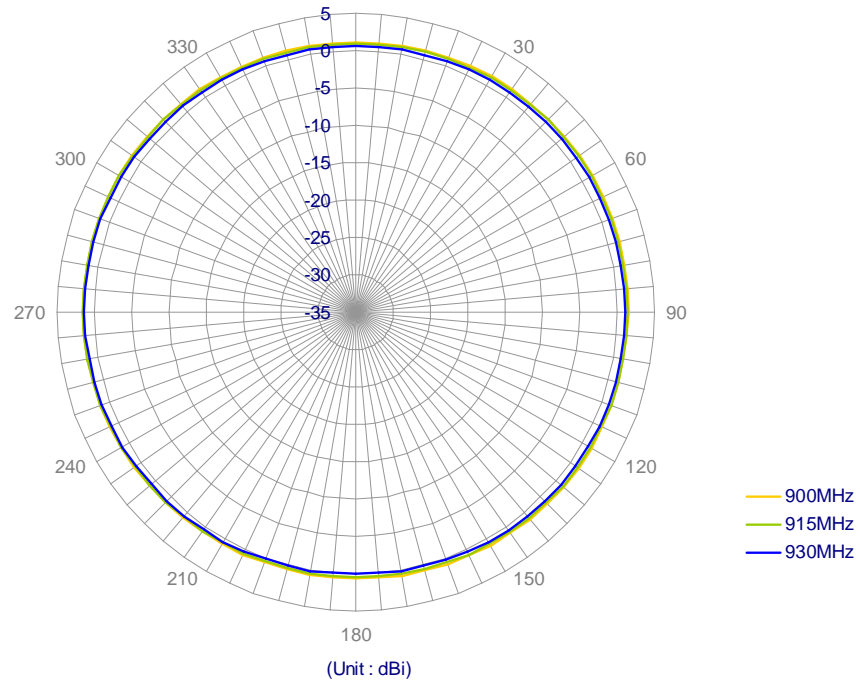

4.5. Radiation Pattern of 180 Degree Straight Position

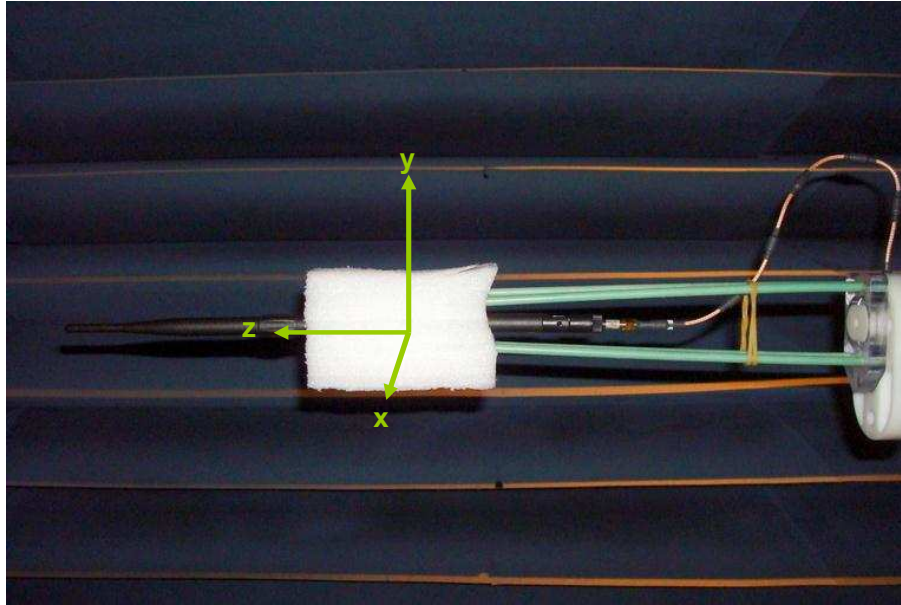

4.5.1 3D Radiation Pattern

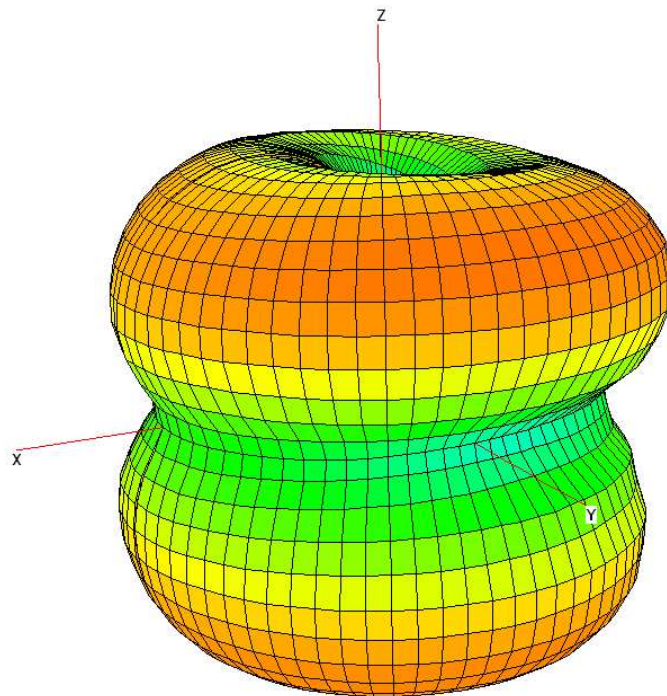

4.5.2 X-Z Plane Radiation

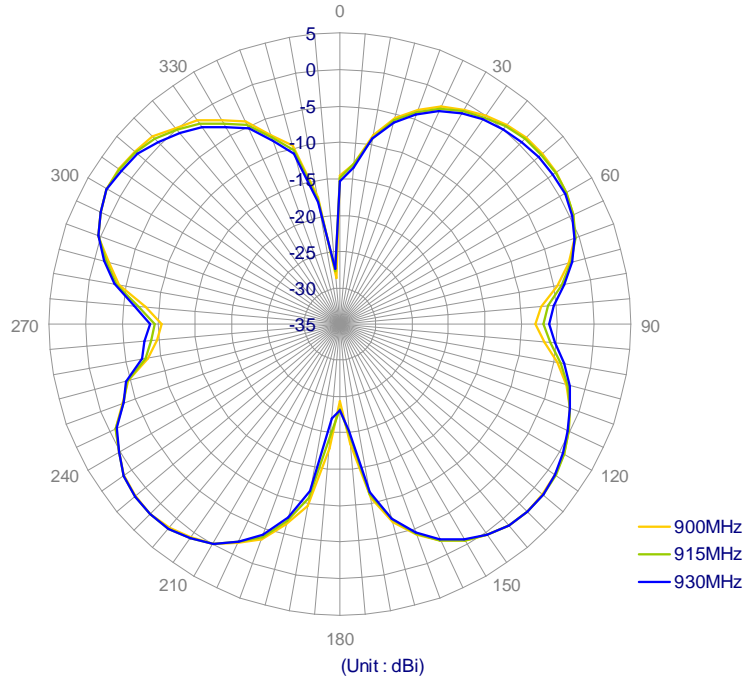

4.5.3 X-Y Plane Radiation

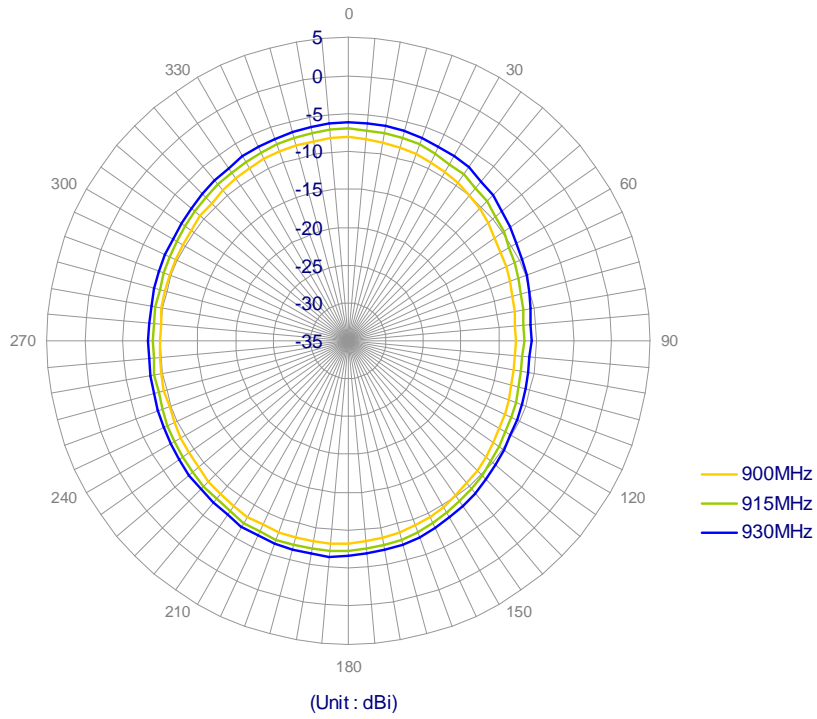

4.5.4 Radiation at 45 Degree from XY Plane

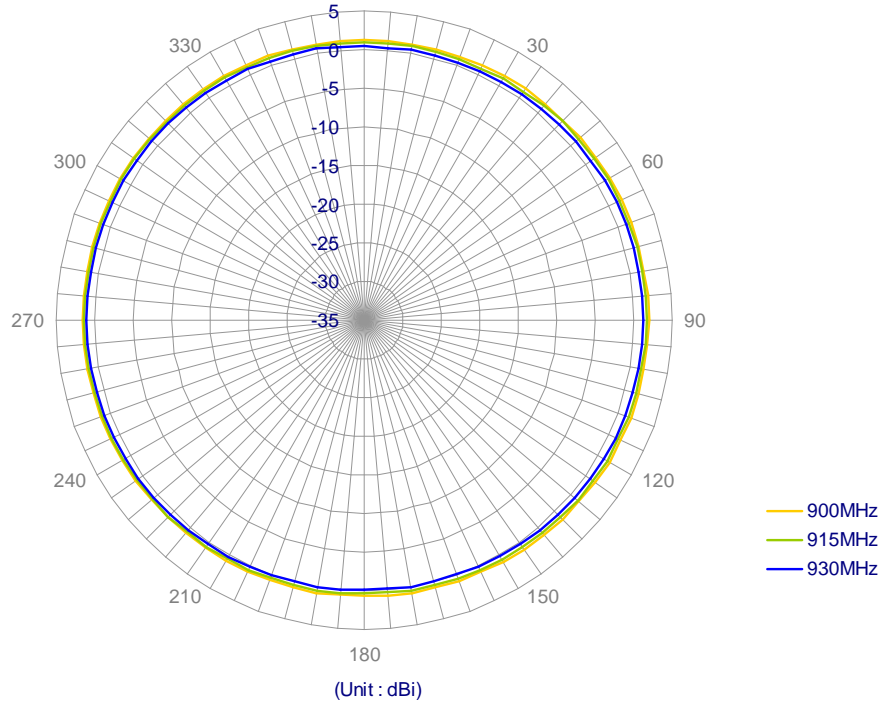

5. Ground Plane Effect

Three ground setups are used to see the affect of positioning TI.19 close to ground -

1. Small Ground (15 x 9cm) – common size of CPE devices. TI.19 is mounted at the longer edge for testing.
2. Big Ground Edge (45 x 30cm) – simulate the effect of mounting antenna on a base station device. TI.19 is mounted at the centre of the longer edge.
3. Big Ground Centre (45 x 30cm) – simulate the effect of mounting antenna in a centre of a big ground plane, such as vehicle top.

5.1. S11 Return Loss

Bend

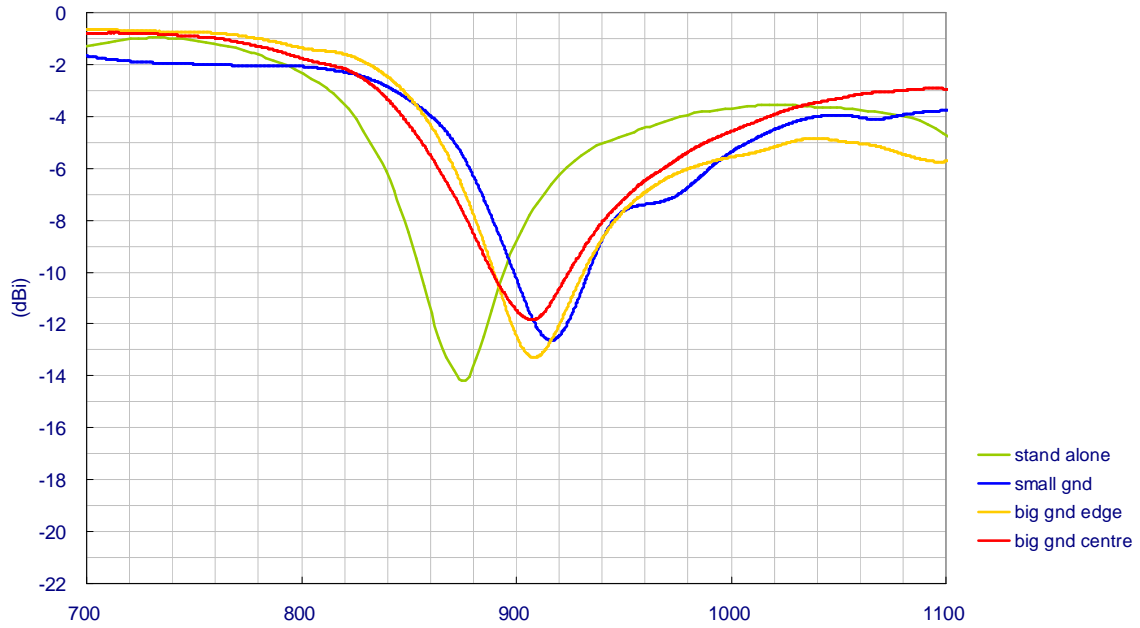

Straight

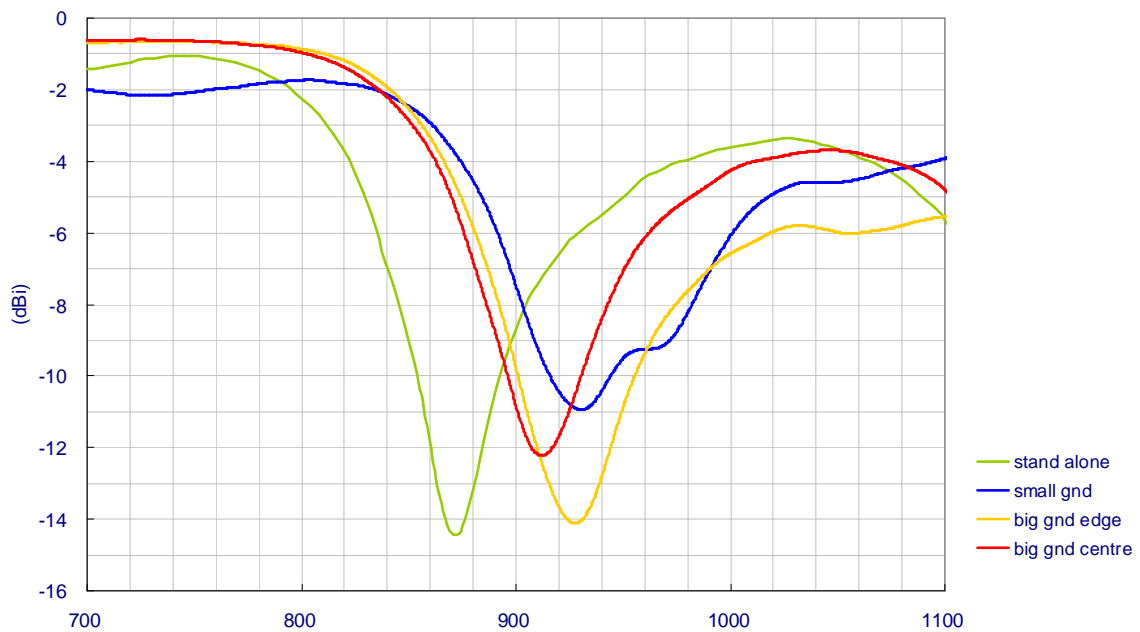

5.2. VSWR

Bend

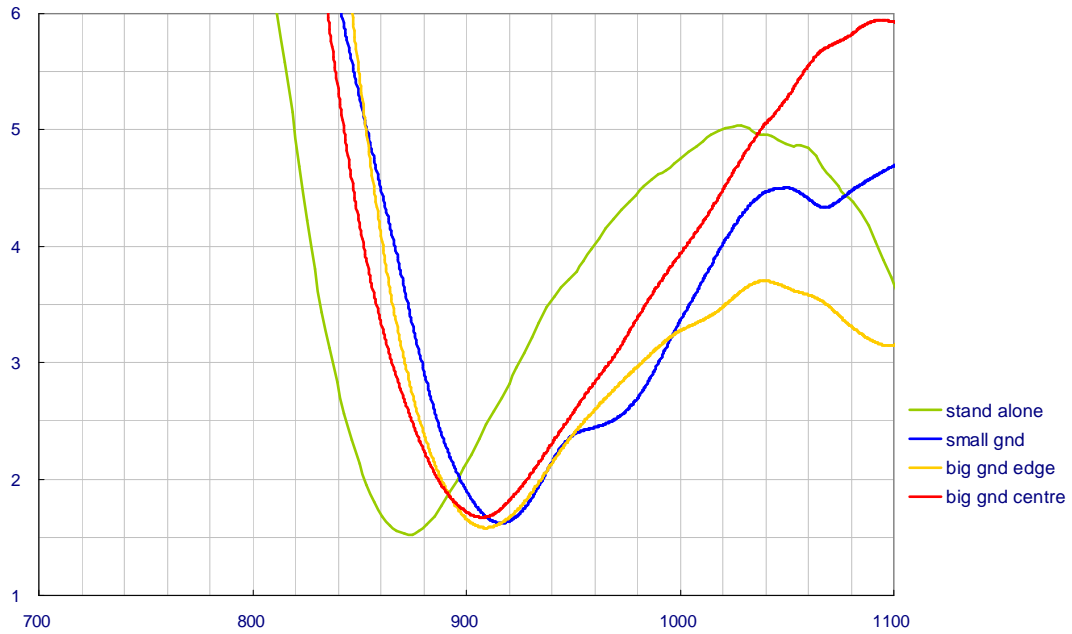

Straight

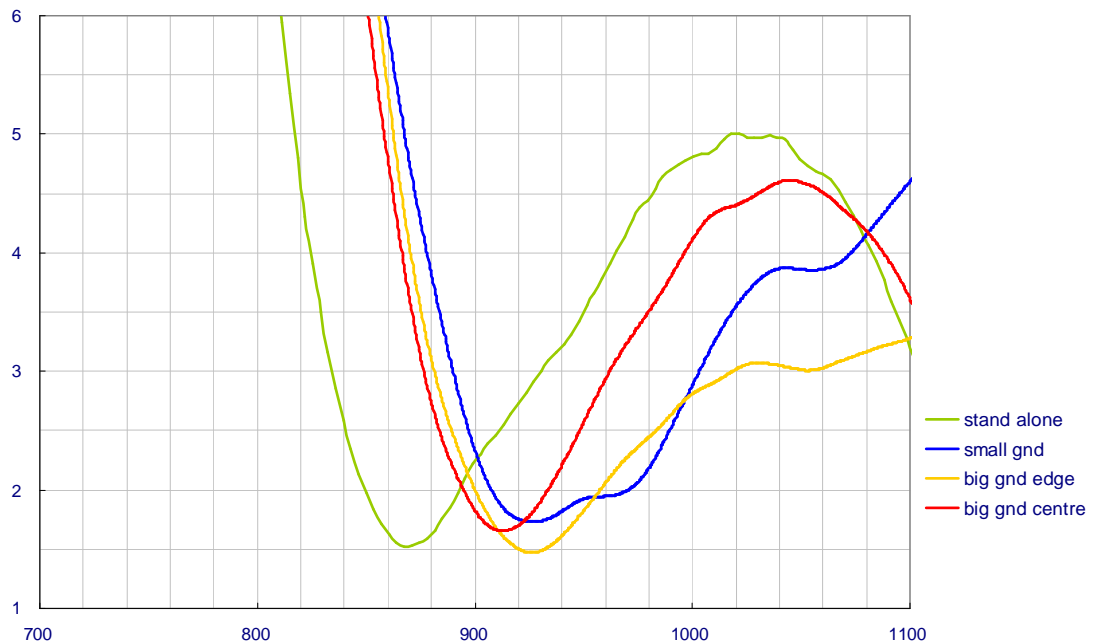

5.3. Radiation Efficiency

Bend

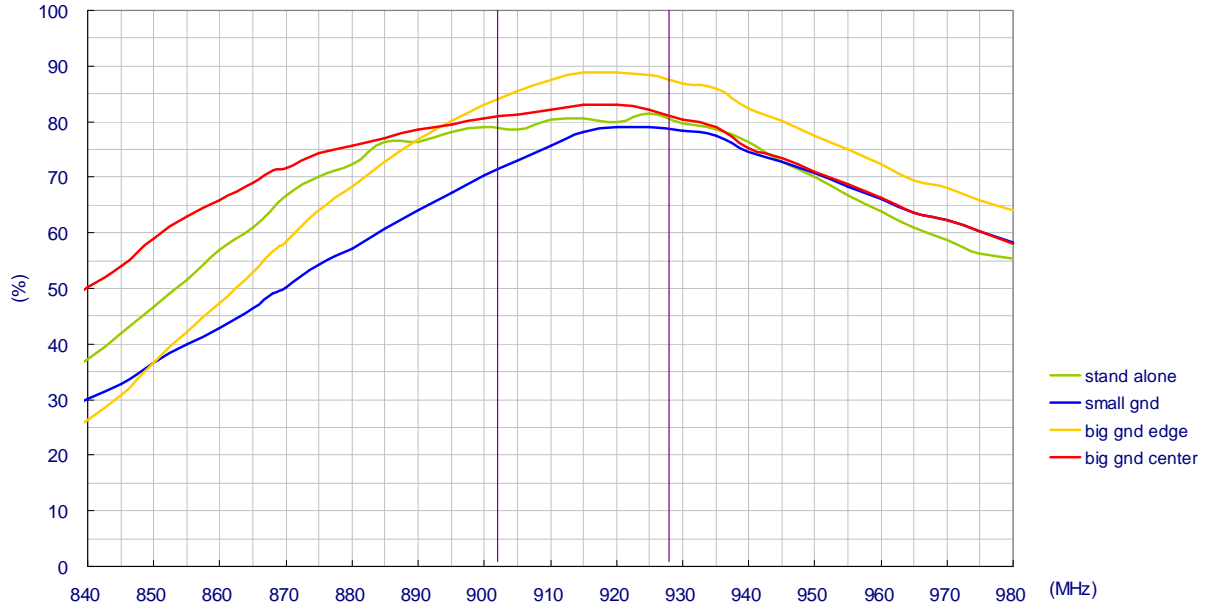

Straight

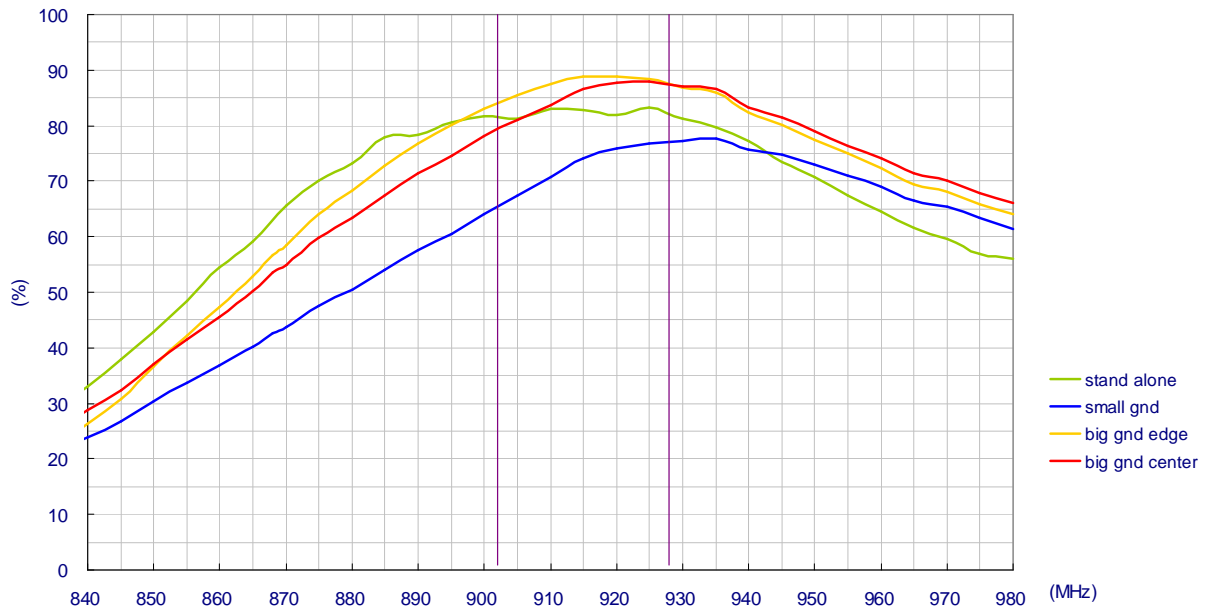

5.4. Average Gain

Bend

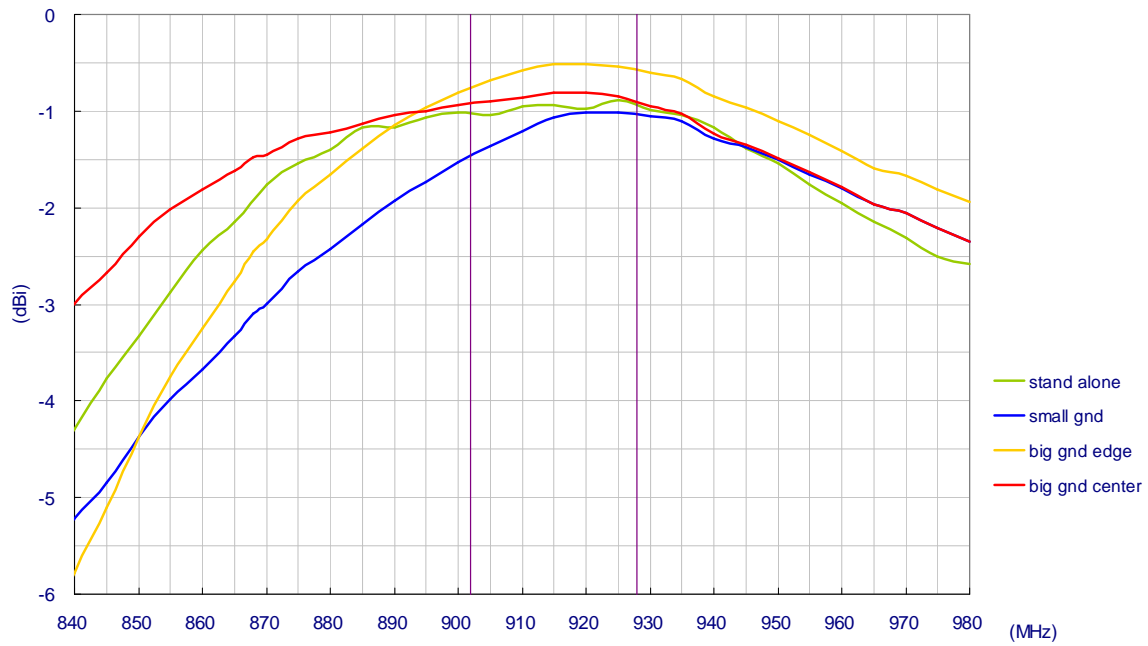

Straight

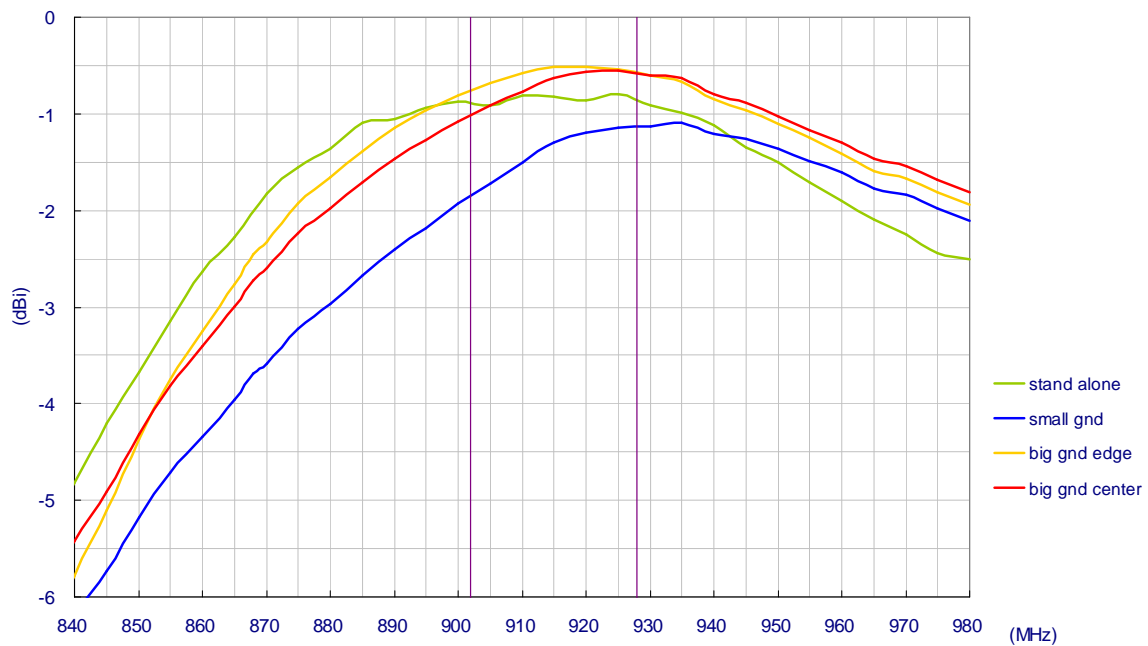

5.5. Peak Gain

Bend

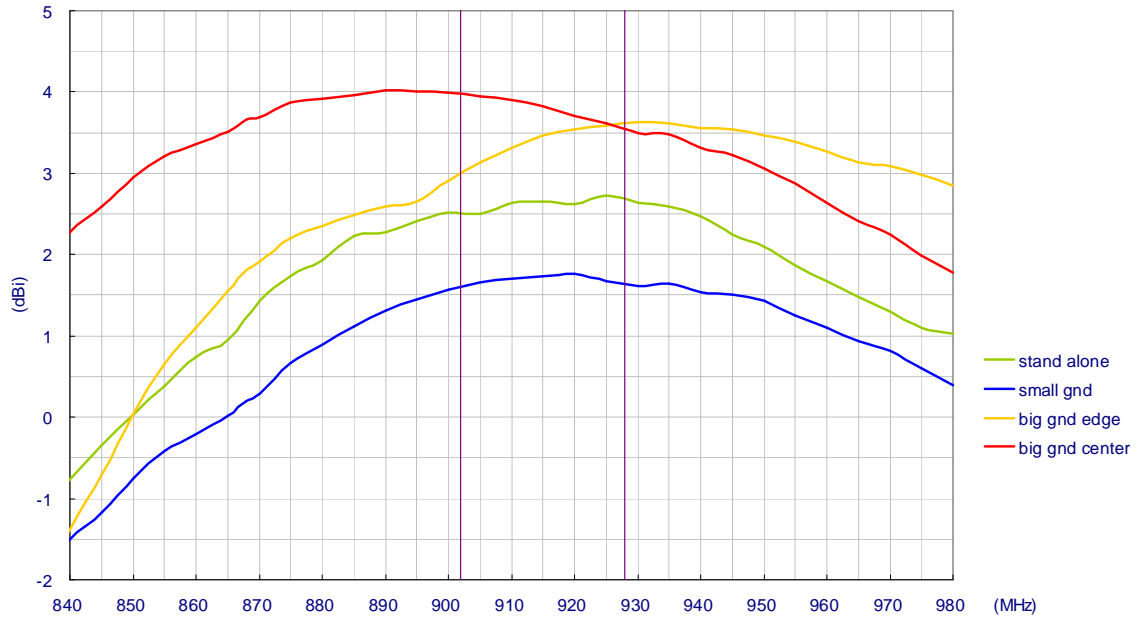

Straight

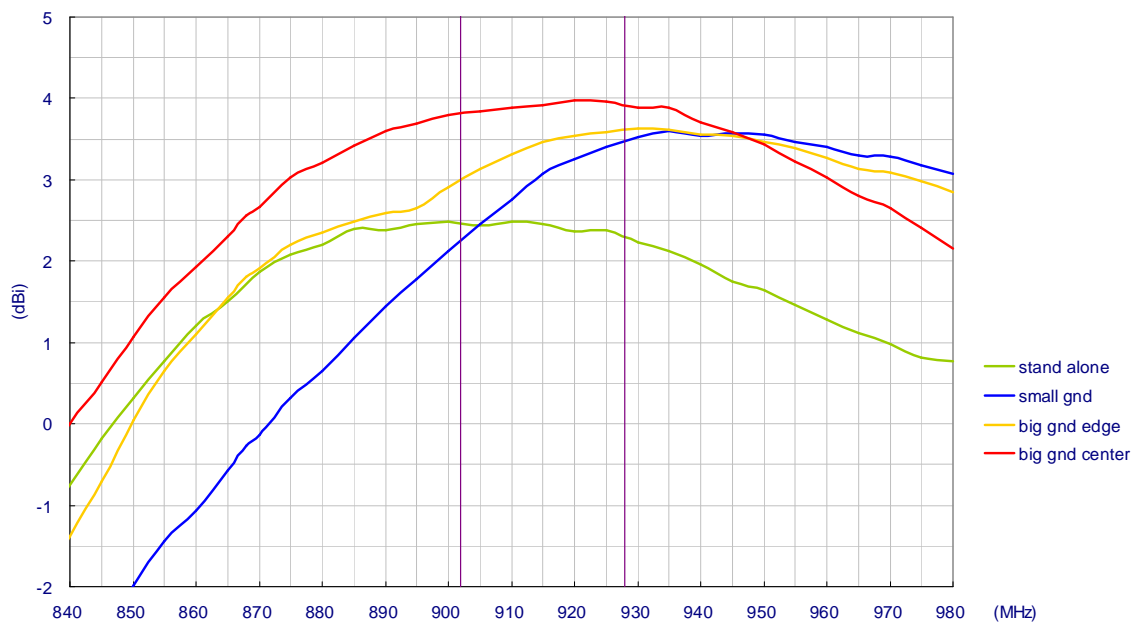

5.6. Radiation Pattern of 90 Degree Bend Position

5.6.1 X-Z Plane Radiation

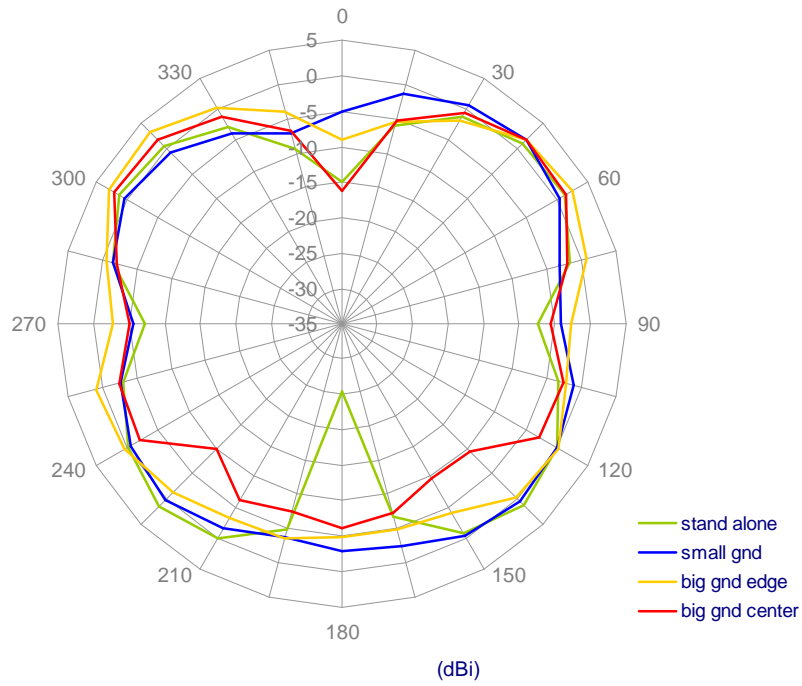

5.6.2 X-Y Plane Radiation

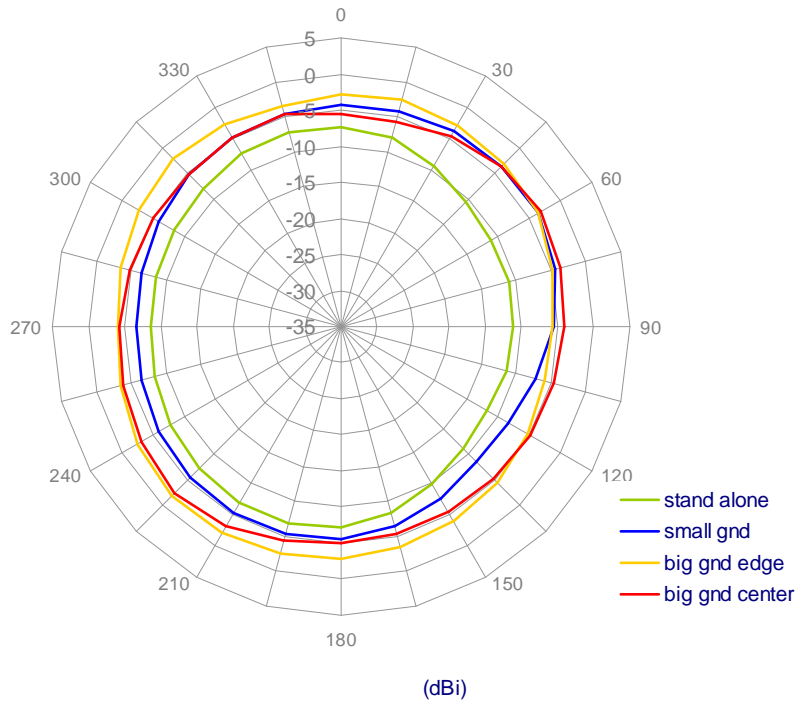

5.6.3 Radiation at 45 Degree from XY Plane

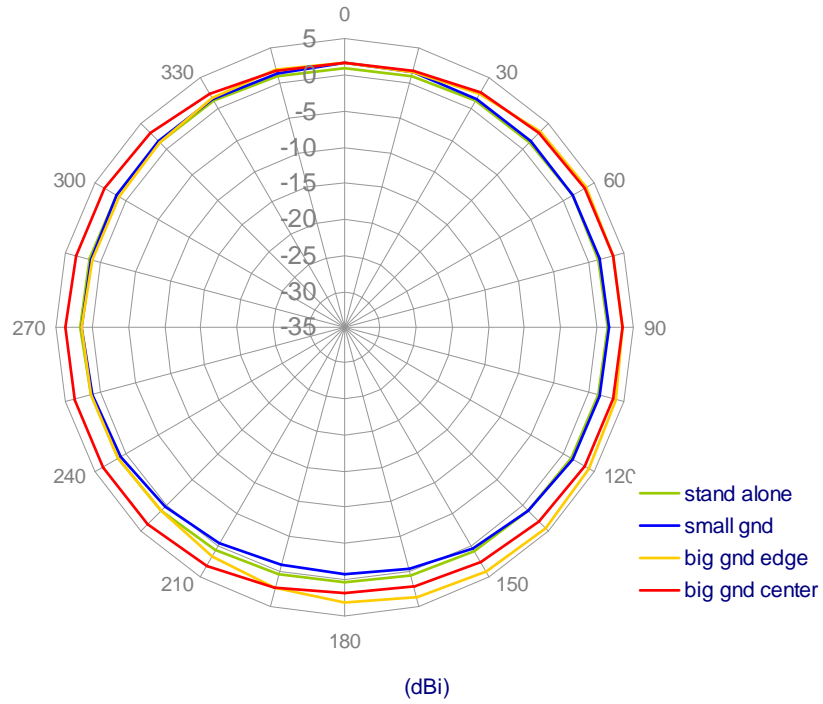

5.7. Radiation Pattern of 180 Degree Straight Position

5.7.1 X-Z Plane Radiation

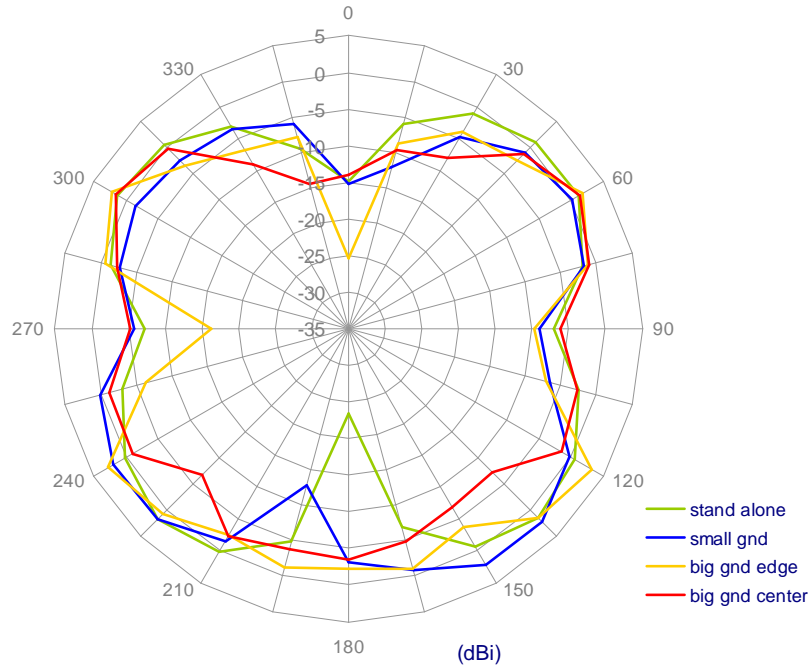

5.7.2 X-Y Plane Radiation

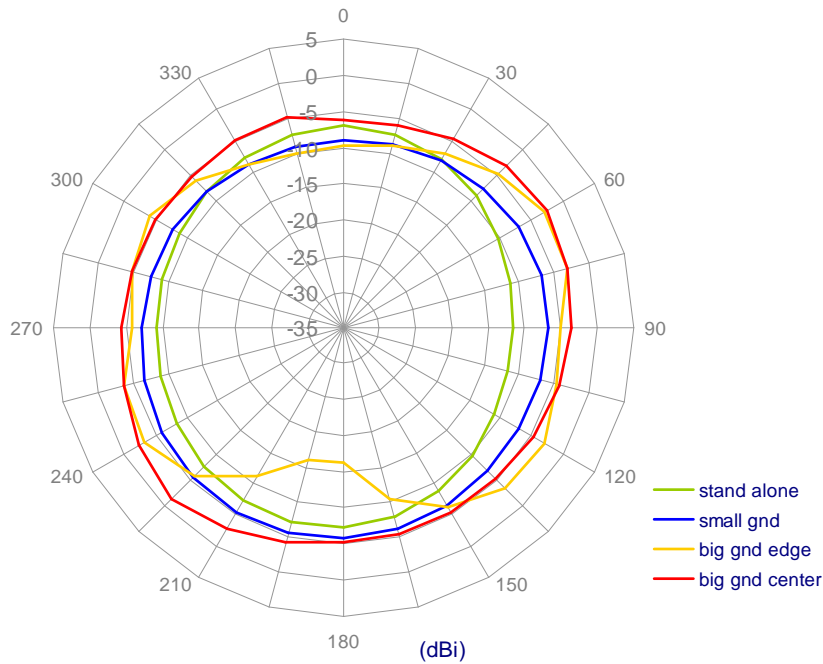

5.7.3 Radiation at 45 Degree from XY Plane

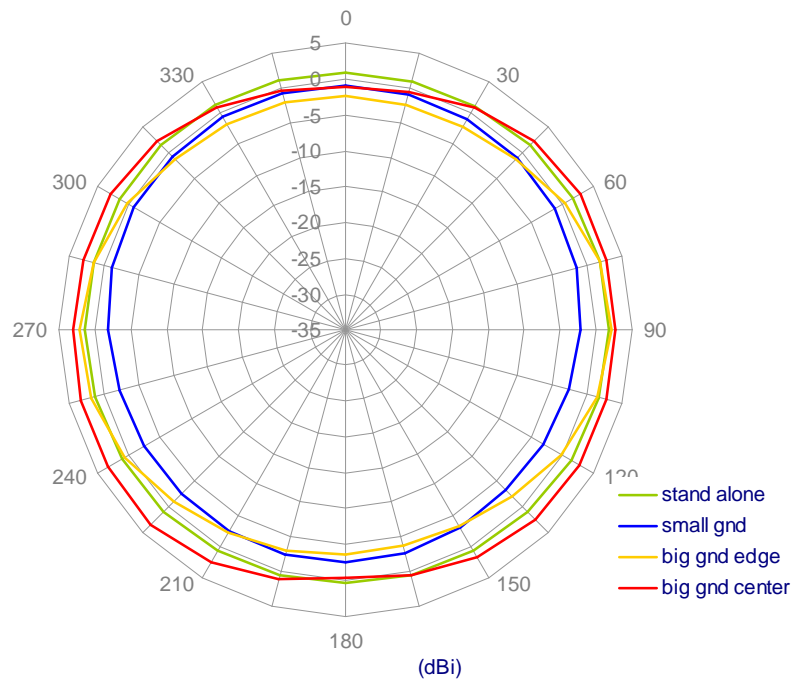

6. Mechanical Drawing

Unit : mm

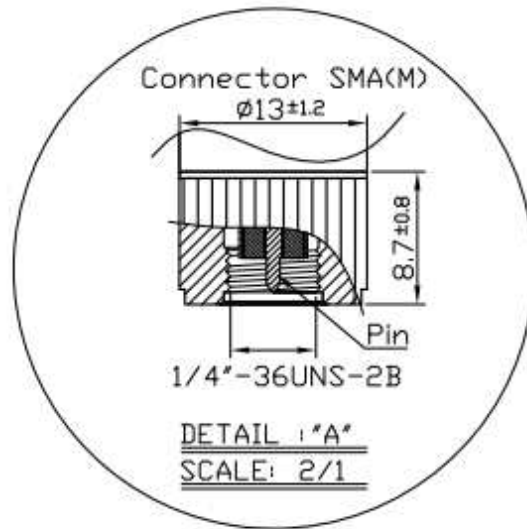
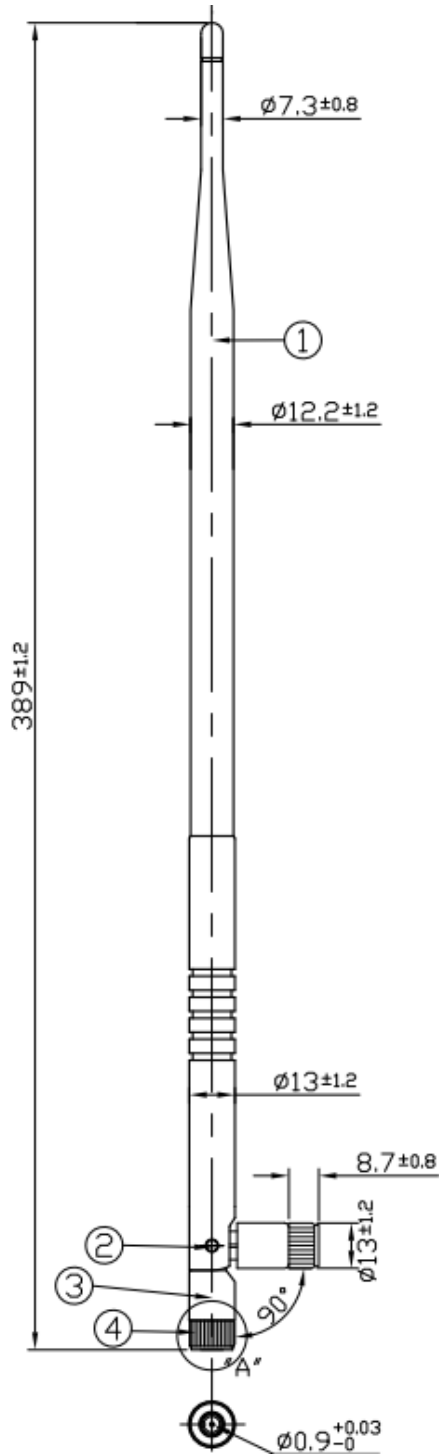

	Name	Material	Finish	QTY
①	Antenna Housing	TPU	Black	1
②	Rotary Shaft	Brass	Black	1
③	Bottom Base	ABS+PC	Black	1
④	SMA(M)	Brass	Black	1