

Specification

Part No.	:	GLA.02
Model	:	1.34dbi 1575Hz GPS Loop Antenna
Description	:	1575.42MHz
Features	:	10*3.2*3.9mm SMT Process Compatible

RoHS ✓



GLA.02 Antenna

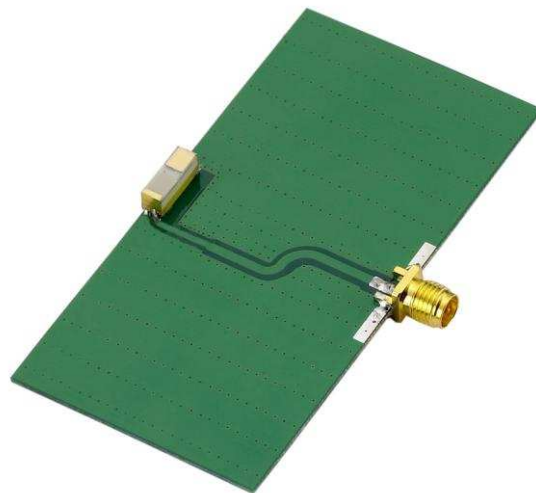

GLAD.02 EVB

I. Introduction

Taoglas have developed a unique ceramic miniature loop antenna series for GPS applications. At 10*3.2*3.9mm, the GLA.02 GPS 1575MHz Loop antenna is a miniature edge mounted antenna, designed for small space requirements. The radiation pattern is more omni-directional than traditional patch antennas. The GLA loop antenna series show at least three times the efficiency of traditional linear polarized 1575 MHz antennas. Efficiencies of 40% to 90% are achievable. Peak gain of 1dBi places this antenna gain performance within the range of a much larger 15mm to 18mm patch antenna.

Mechanically, this antenna does not need ground removed on the back-side of the PCB thus allowing other components to be placed there on crowded boards. Based on the loop effect this antenna works best when placed on the centre of the edge of the board, but can still work better than traditional linear polarized chip antennas even when placed at corners as substitute.

The GLA.02 is delivered on tape and reel and now allows M2M customers to use an omni-directional antenna in devices where orientation of the product is unknown.

Applications

- *navigation or position tracking systems
- *Hand-held devices when GPS function is needed, e.g., Smart phone. PDA, PND

II. Key Performance Indicators

The antenna performance was measured with the GLA.02 mounted on an evaluation board (80*40mm ground plane) with SMA(F) connector.

No	Parameter	Specification
1	Center Frequency	1575.42±2MHz
2	Dimensions	10*3.2*3.9mm
3	VSWR	2 max (depends on the special environment)
4	Polarization	Linear
5	Bandwidth	20MHz Min.(under -10dB return Loss)
6	Gain	Peak 1.34dBi typ. Average -3.78dBi typ.
7	Efficiency	40-90%
8	Impedance	50 Ω
9	Operating Temperature	-40°C~+85°C
10	Temperature Coefficient (τf)	0 ± 20 ppm @-20°C to +80°C

* Center frequency will be offset to working frequency according to the conditions of user's Ground plane and radome.

**The data was measured by A Test Lab Techno Corp. (CTIA Authorized Test Lab).

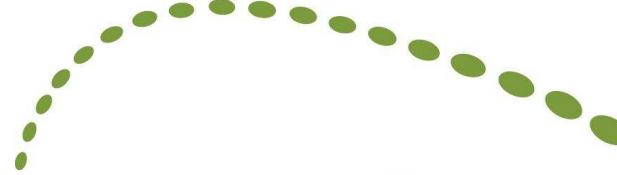

III. Antenna Dimensions (unit:mm)

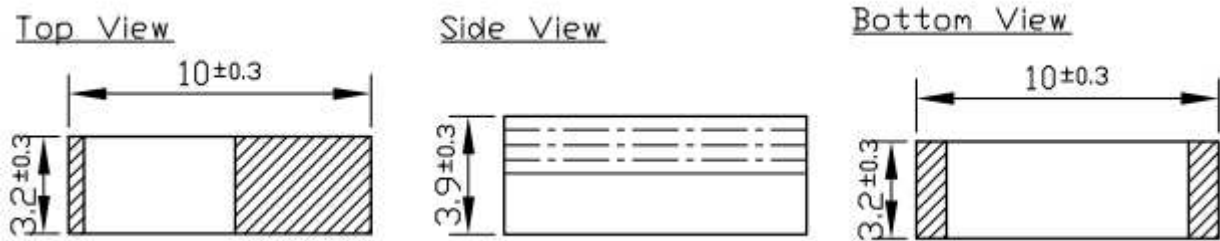

III.I Test Board (unit:mm)

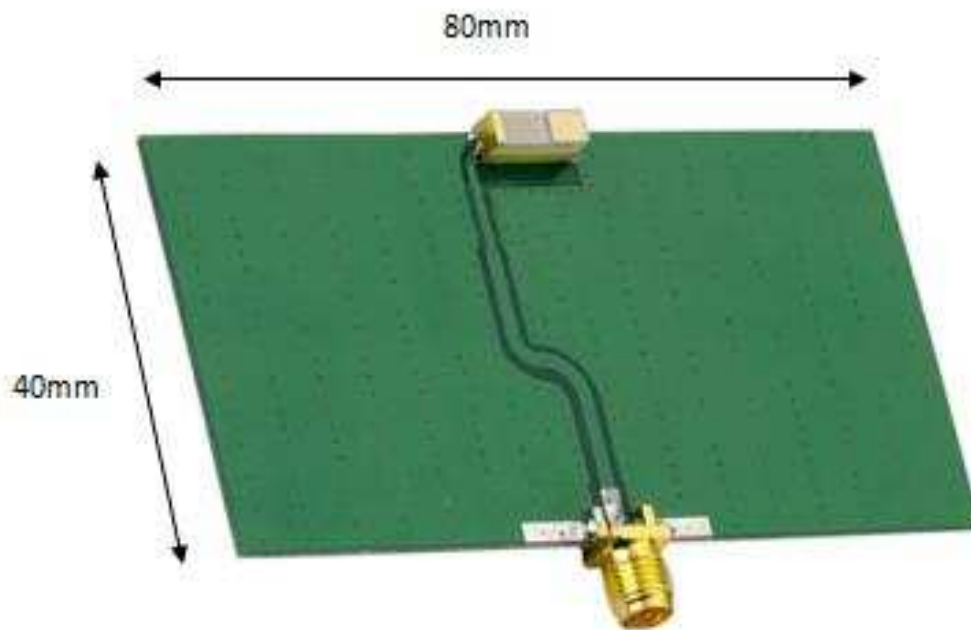

IV. Electrical Characteristics (80*40mm ground plane)

IV.1 Return Loss (S11)

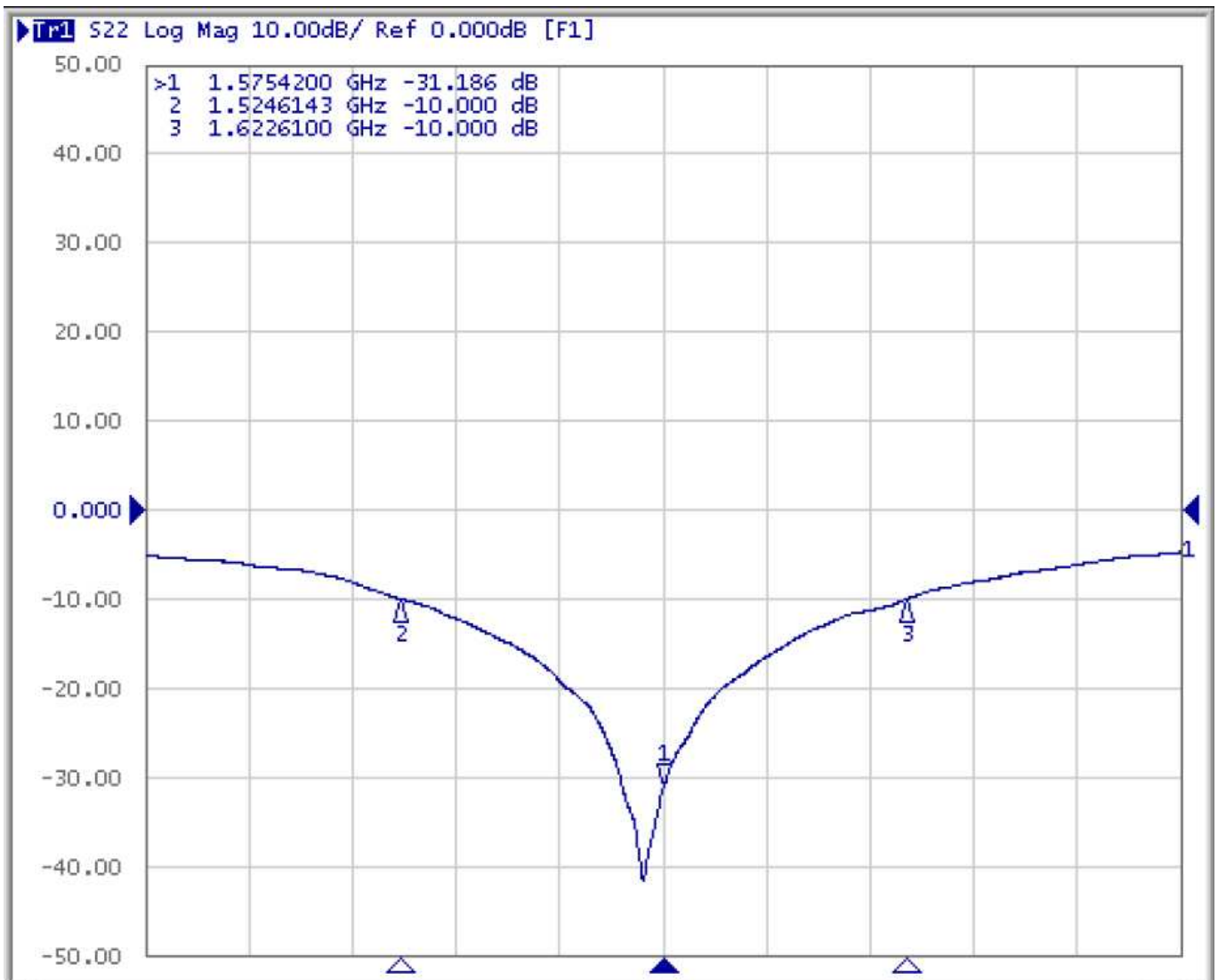

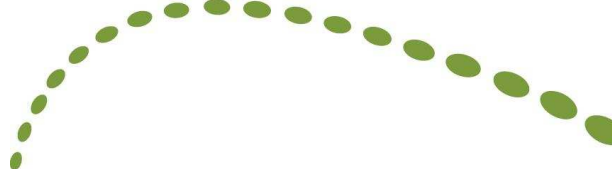

IV.2 Impedance (Smith Chart)

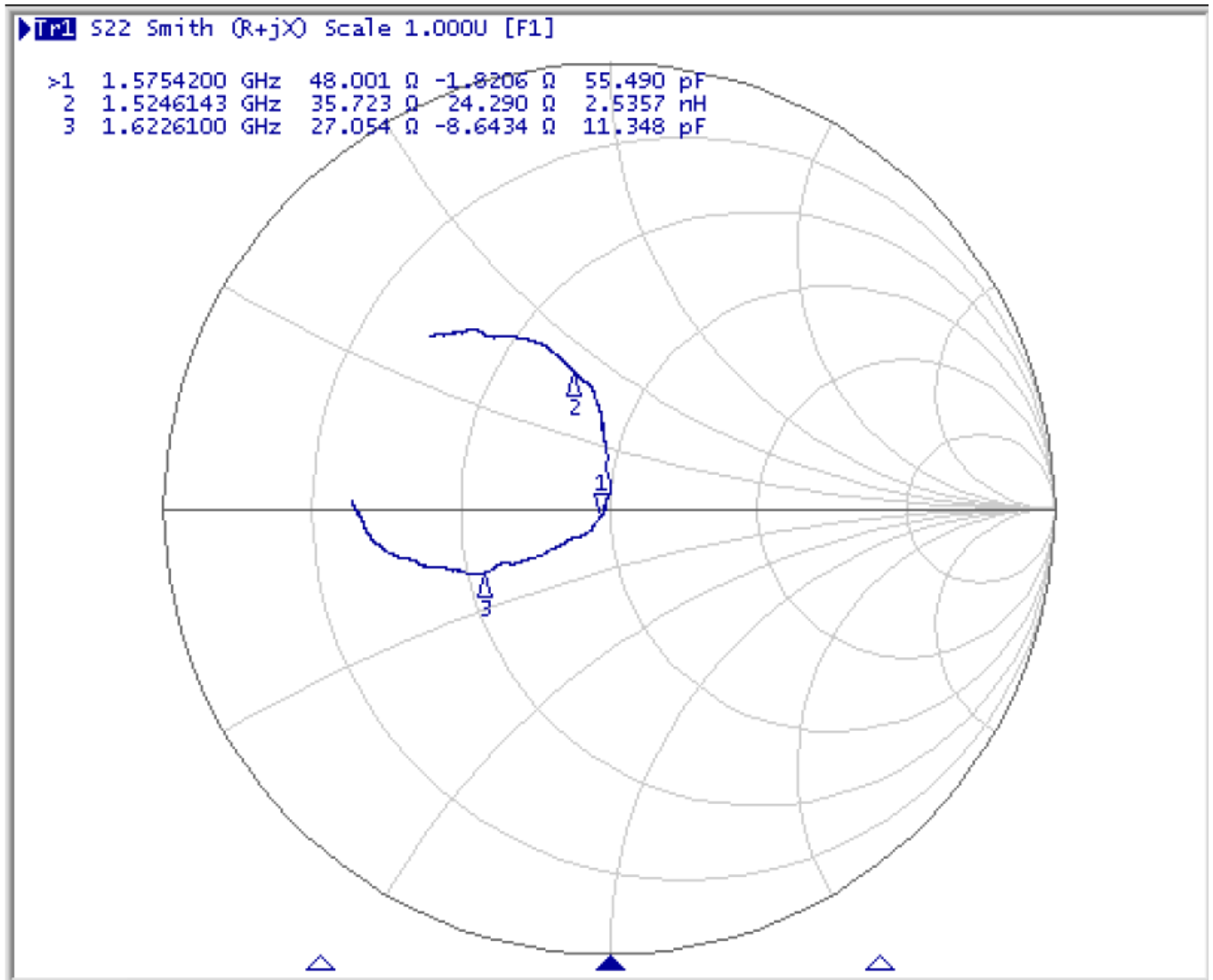

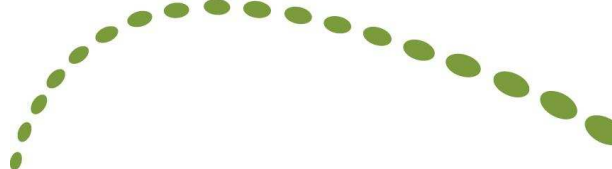

V. Radiation Pattern (Customize Design)

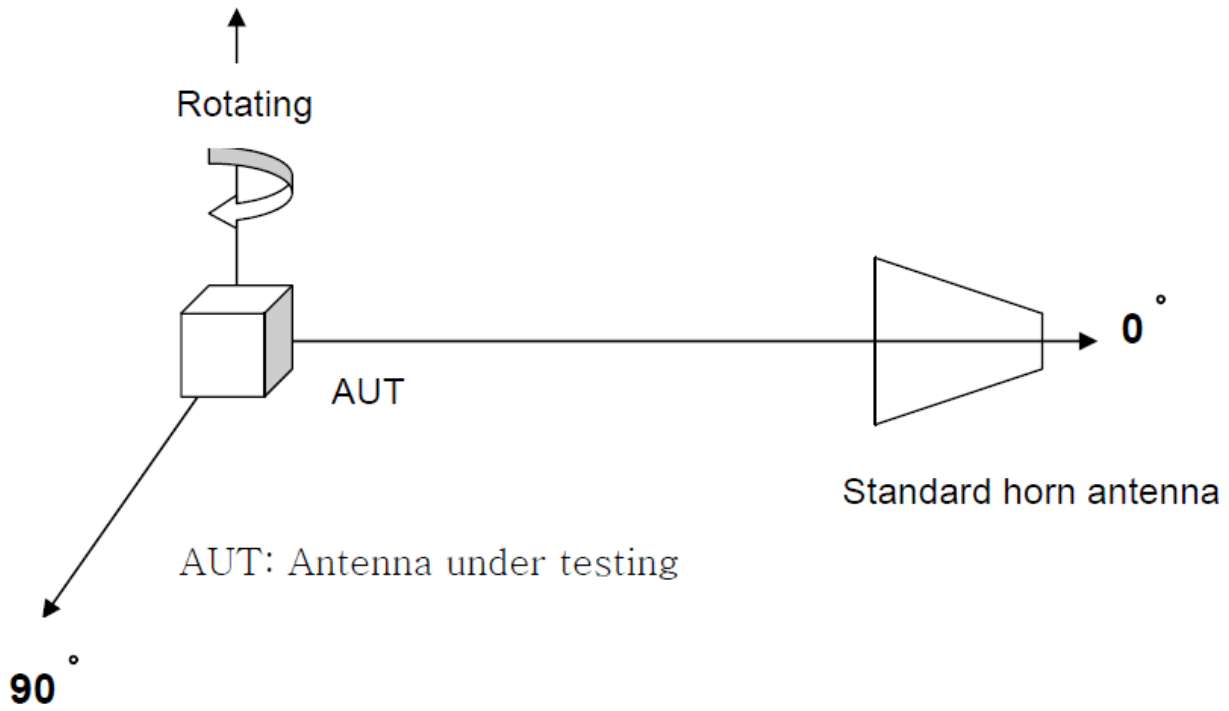

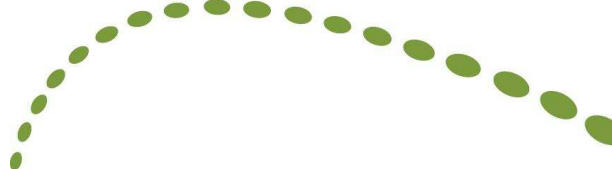

V.1 Radiation Pattern

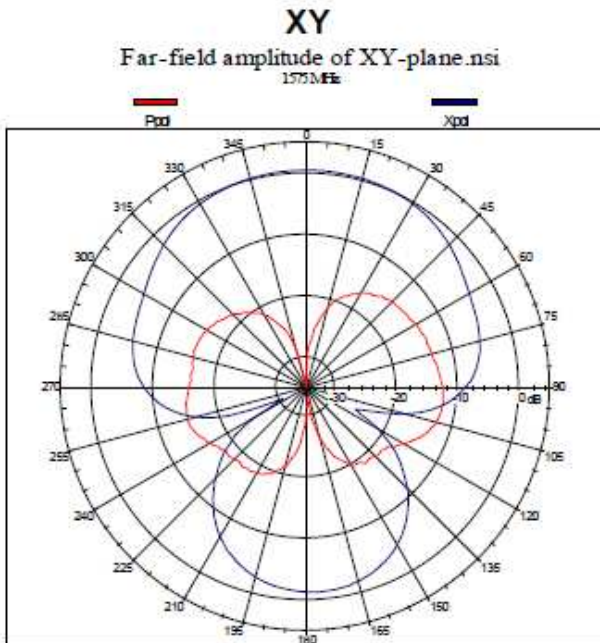
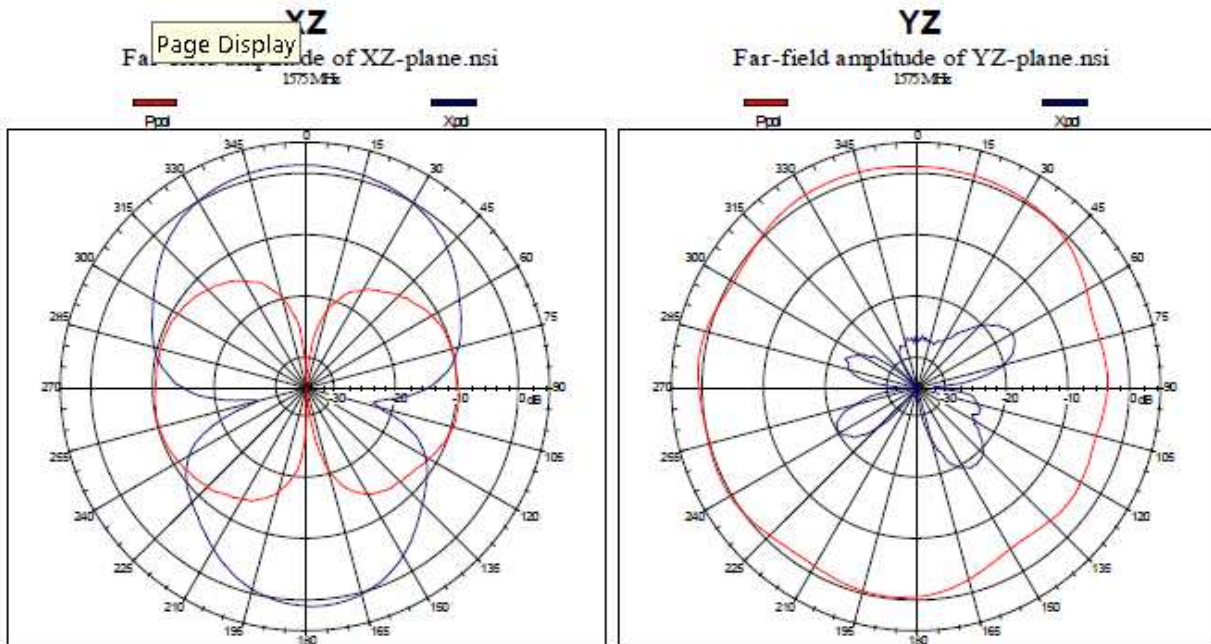

- Ppd - Vertical Polarization
- Xpd - Horizontal Polarization

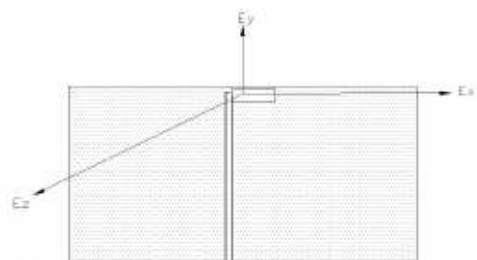

Linear polarized signal $f_0=1575.42\text{MHz}$

V.2 Total gain

Plane	XZ	YZ	XY
Peak gain	1.27	1.34	0.38
Average Gain	-4.31	-1.3	-5.72

VI. Layout Guide

VI.1 Solder Land pattern

Land pattern for soldering (grey marked areas) is as shown below. Depending on Customers requirement, matching circuit as shown below is also recommended. The footprint is 11*5.7mm, this antenna does not need ground removed on the back-side of the PCB thus allowing other components to be placed there on crowded boards.

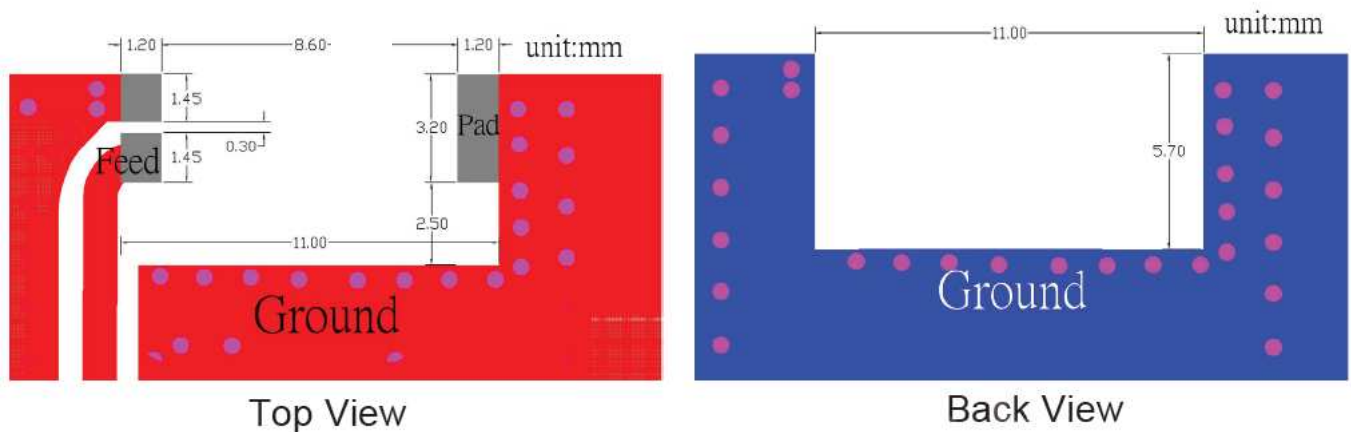

VI.2 Matching Circuit

The most common matching arrangement is the pi matching as shown below. We have 2.2pF capacitor for Component 3 and 00hm resistor for Component 2 on EVB.

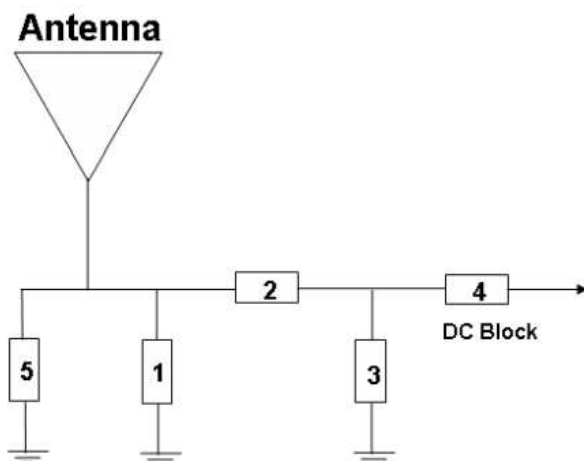

System Matching Circuit Component		
Location	Description	Vendor
1	1.8pF	TDK(0402)
2	4.7pF	TDK(0402)
3	N/A	-
4	22pF	TDK(0402)
5 (Fine tuning element)	8pF	TDK(0402)

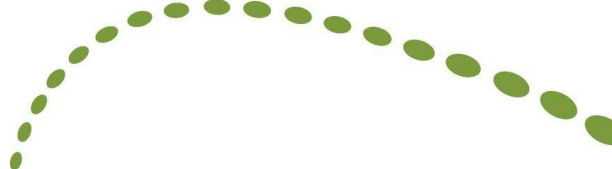

VI.3 Recommended Reflow Profile

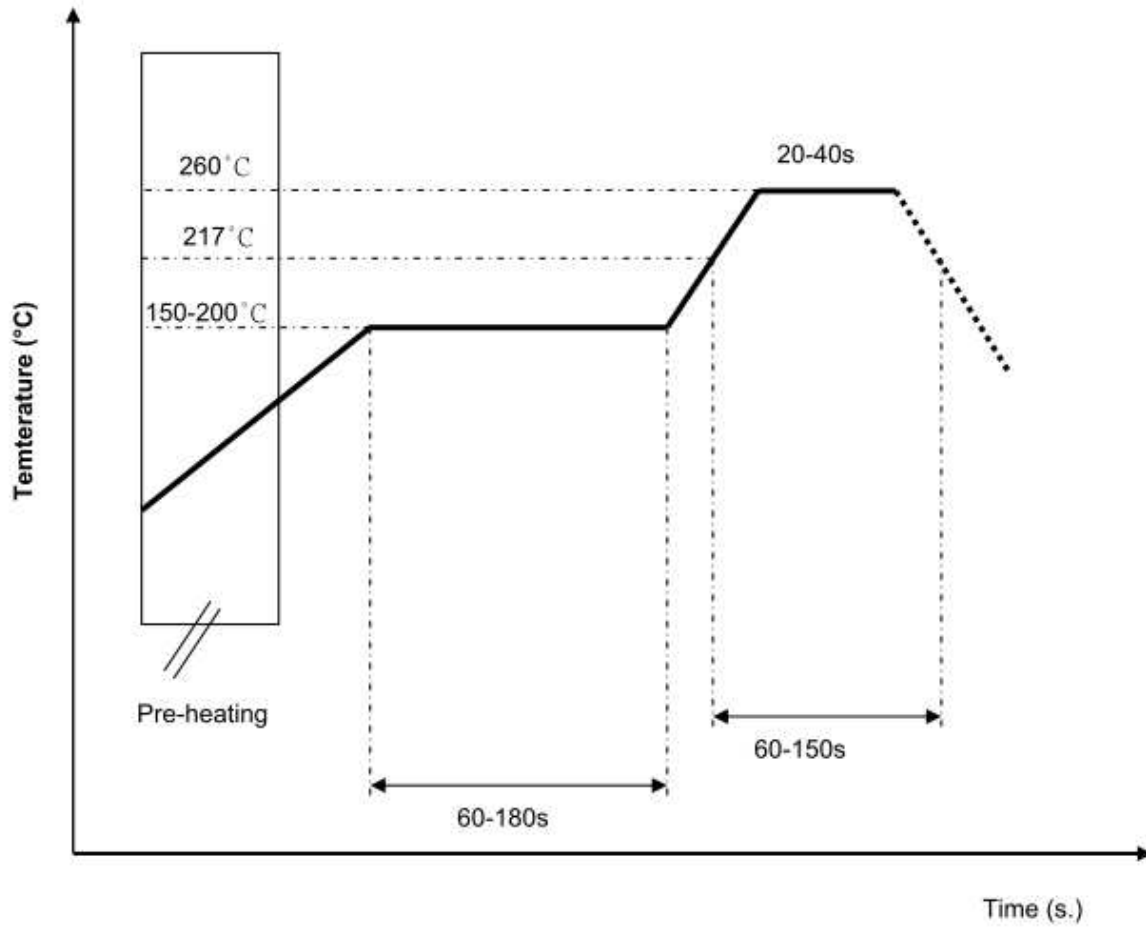

VII. Packing

- (1) Quantity/Reel: 2000pcs/Reel
- (2) Plastic Tape

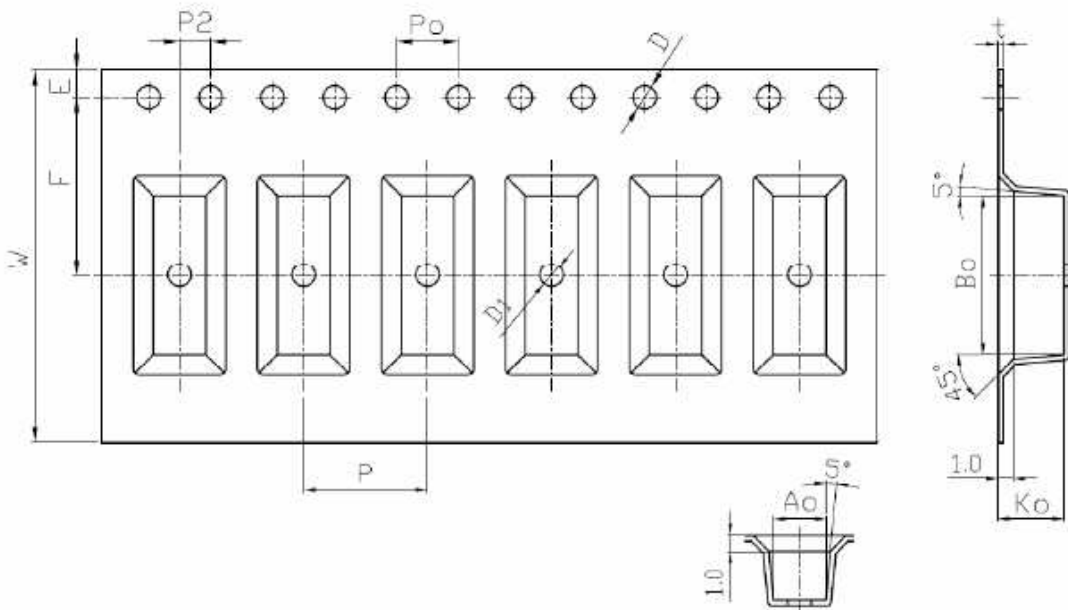

1. Cumulative tolerance of 10 sprocket hole pitch: $\pm 0.20\text{mm}$
2. Carrier camber not to exceed 1mm in 250mm
3. A_o and B_o measured on a plane 0.3mm above the bottom of the pocket.
4. K_o measured from a plane on the inside bottom of the pocket to the top surface of the carrier.
5. All dimensions meet EIA-481-B requirements.
6. Material: Clear Non Anti-Static Polystyrene.
 Black Conductive Polystyrene.

7.1 Tape Dimensions (unit: mm)

Feature	Specifications	Tolerance
W	24	± 0.30
P	8	± 0.10
E	1.75	± 0.10
F	11.50	± 0.10
P2	2	± 0.10
D	1.50	± 0.10
Po	4	± 0.10
10Po	40	± 0.20

.2 Pocket Dimensions (unit: mm)

Feature	Specifications	Tolerances
A_o	3.4	± 0.10
B_o	10.30	± 0.10
K_o	4.25	± 0.10
t	0.35	± 0.05