

SPECIFICATION

Part No. : **GW26.0112**

Product Name : 2.4GHz Miniature Screw mount Monopole Antenna

Feature : SMA(M)R/A Connector
ROHS Compliant



1 Introduction

The GW.26 2.4 GHz Monopole SMA(M)R/A mount antenna is ideal for 2.4 GHz wireless applications such as Bluetooth and Wireless LAN. Connector mount is fully customizable.

2 Specification

Wi-Fi 2.4GHz	
Frequency	2400~2500MHz
Bandwidth	1000MHz
Peak Gain	> 0dBi
Radiation Efficiency	> 40%
Radiation	Omni-directional
Polarization	Vertical
Power Handling 1W Max	Power Handling 1W Max
Electrical Wave	1/2 Monopole
Impedance	50Ω
Operating Temperature	-40°C ~ +85°C
Storage Temperature	-40°C ~ +85°C

3 Mechanical Properties

Mechanical Properties	
Colour	Black and Green
IP rating	IP-65
Connector	SMA(M) R/A

4 Antenna Characteristics

4.1 Antenna S11

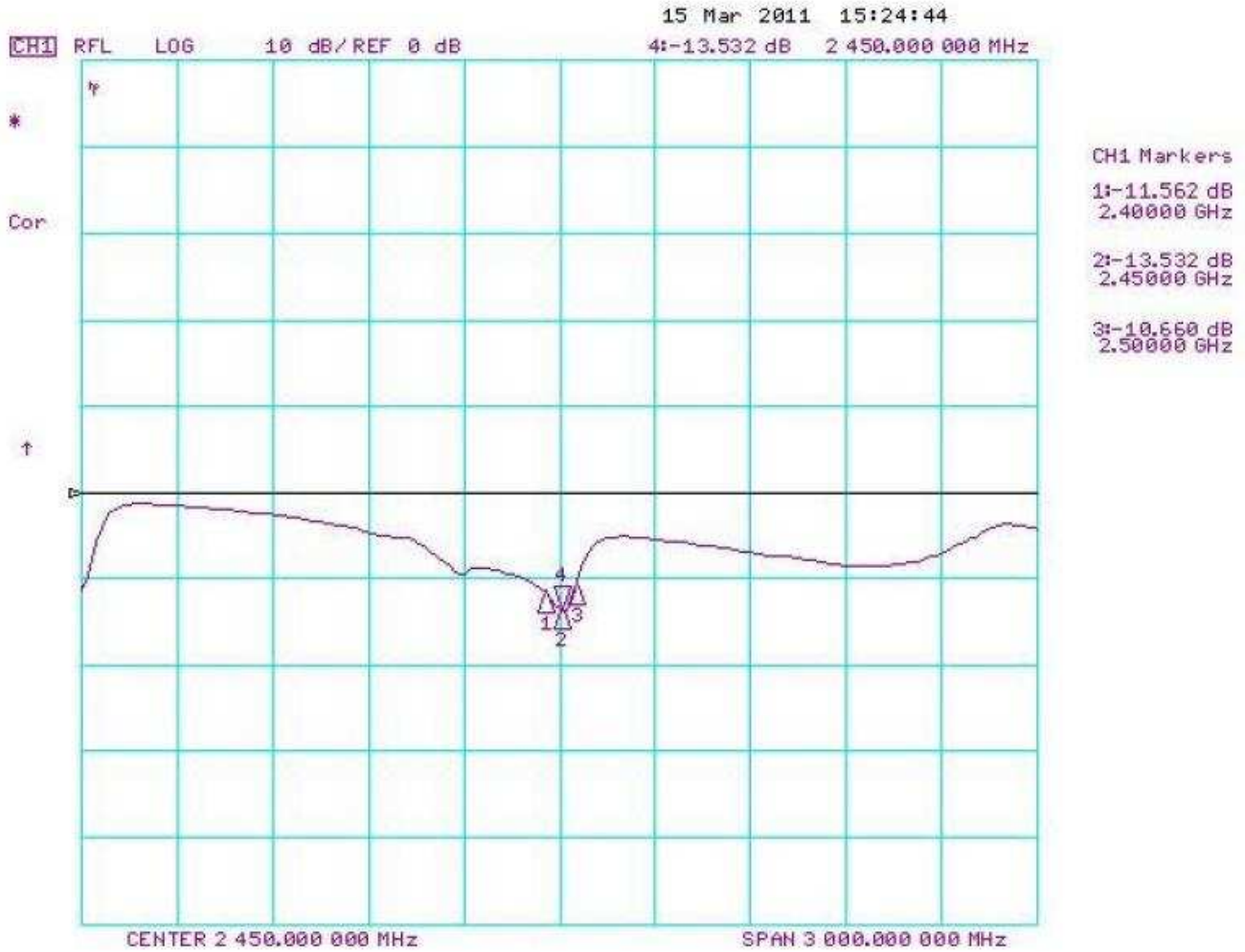

4.2 Antenna Peak Gain

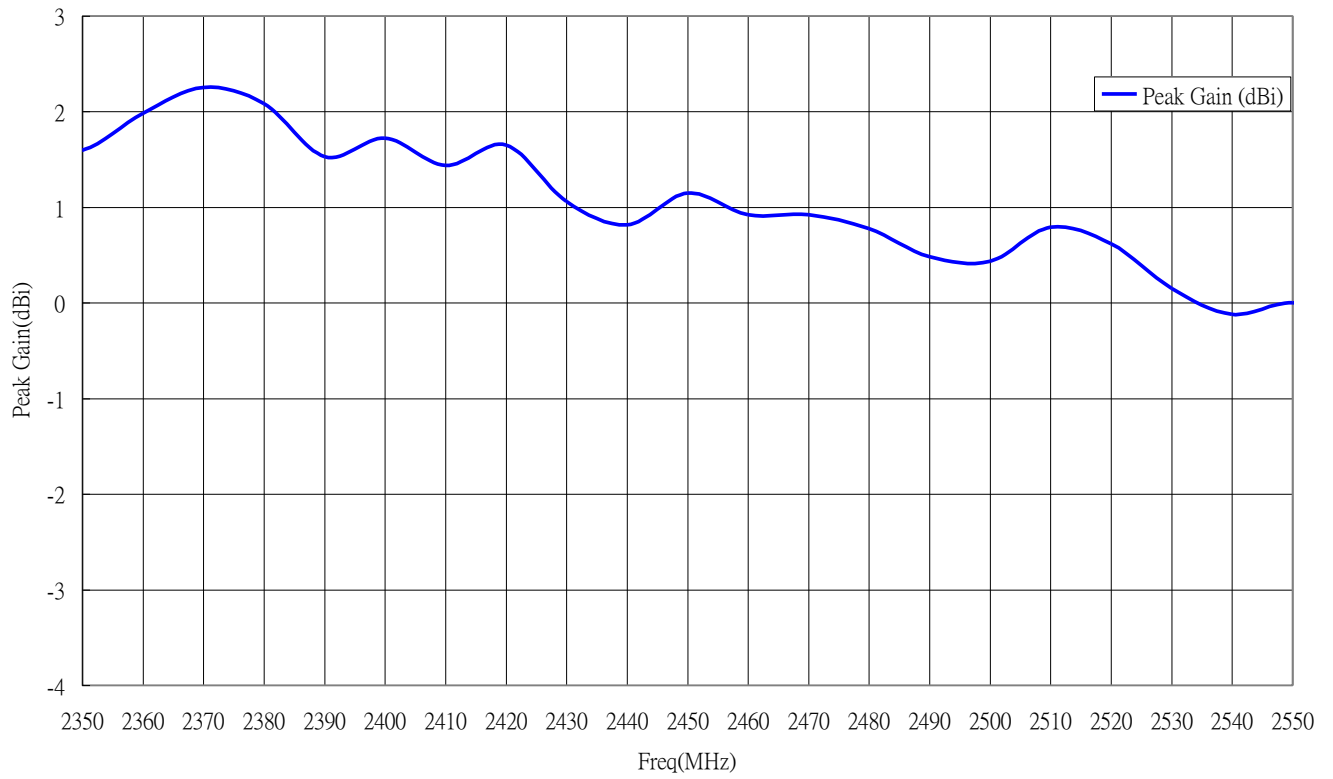

4.3 Antenna Efficiency

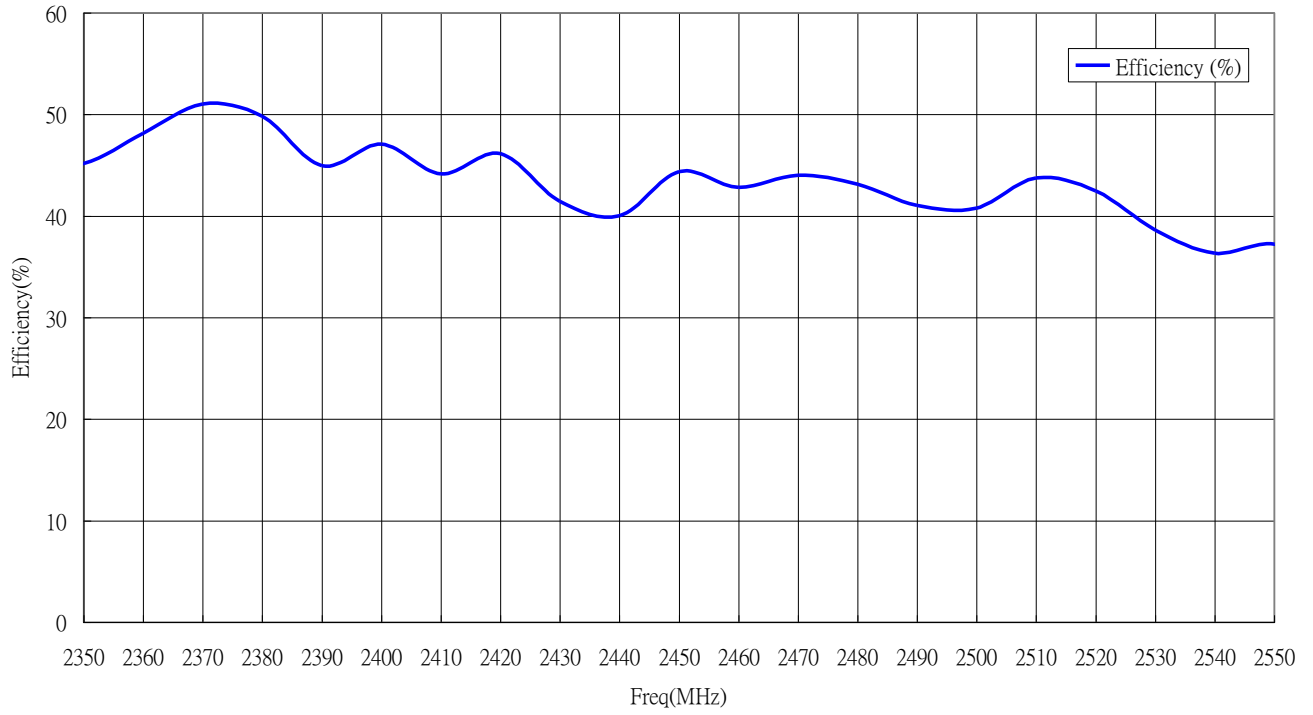

4.4 Antenna pattern (XY plane)

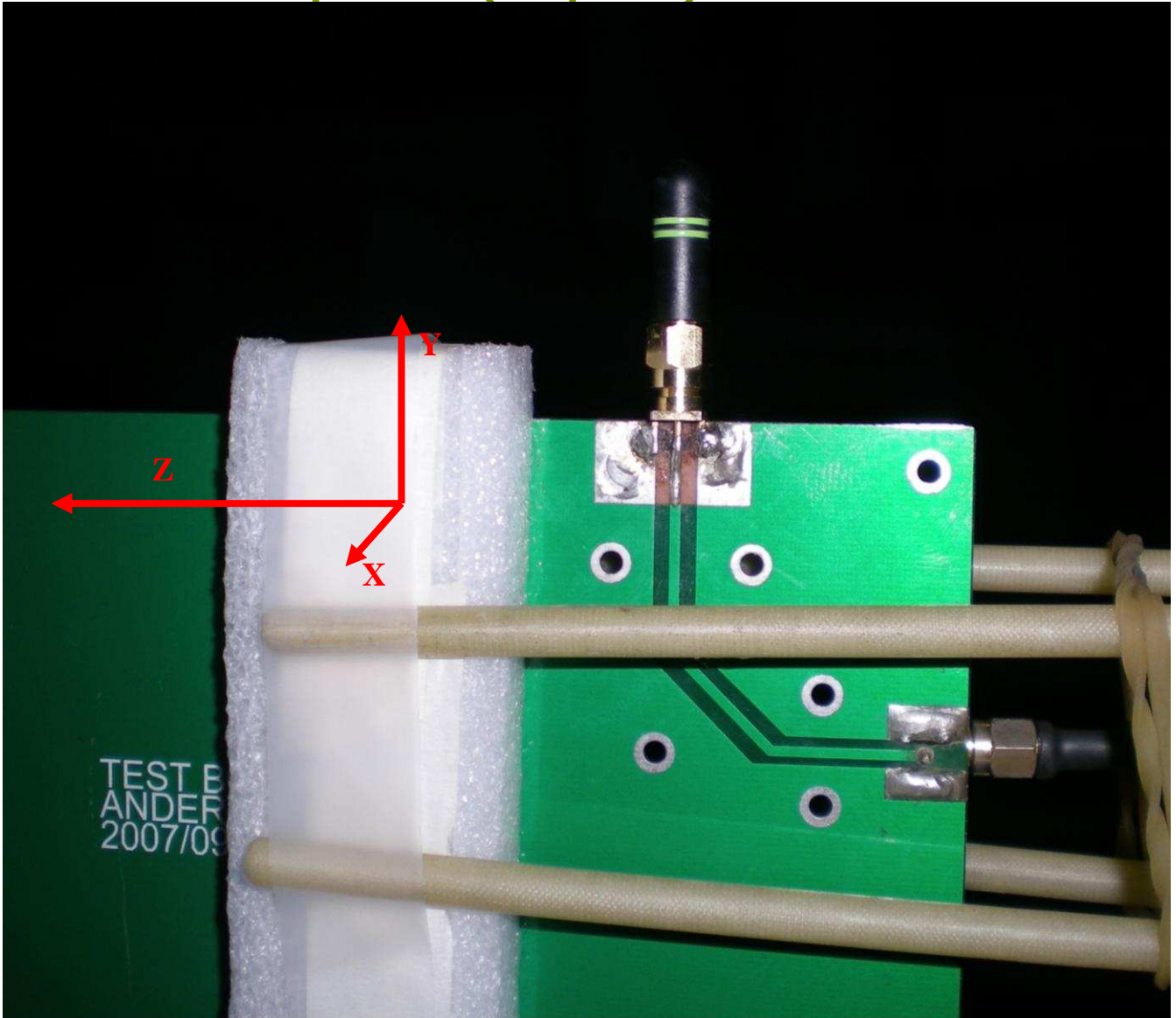

4.5 Antenna pattern (XY plane)

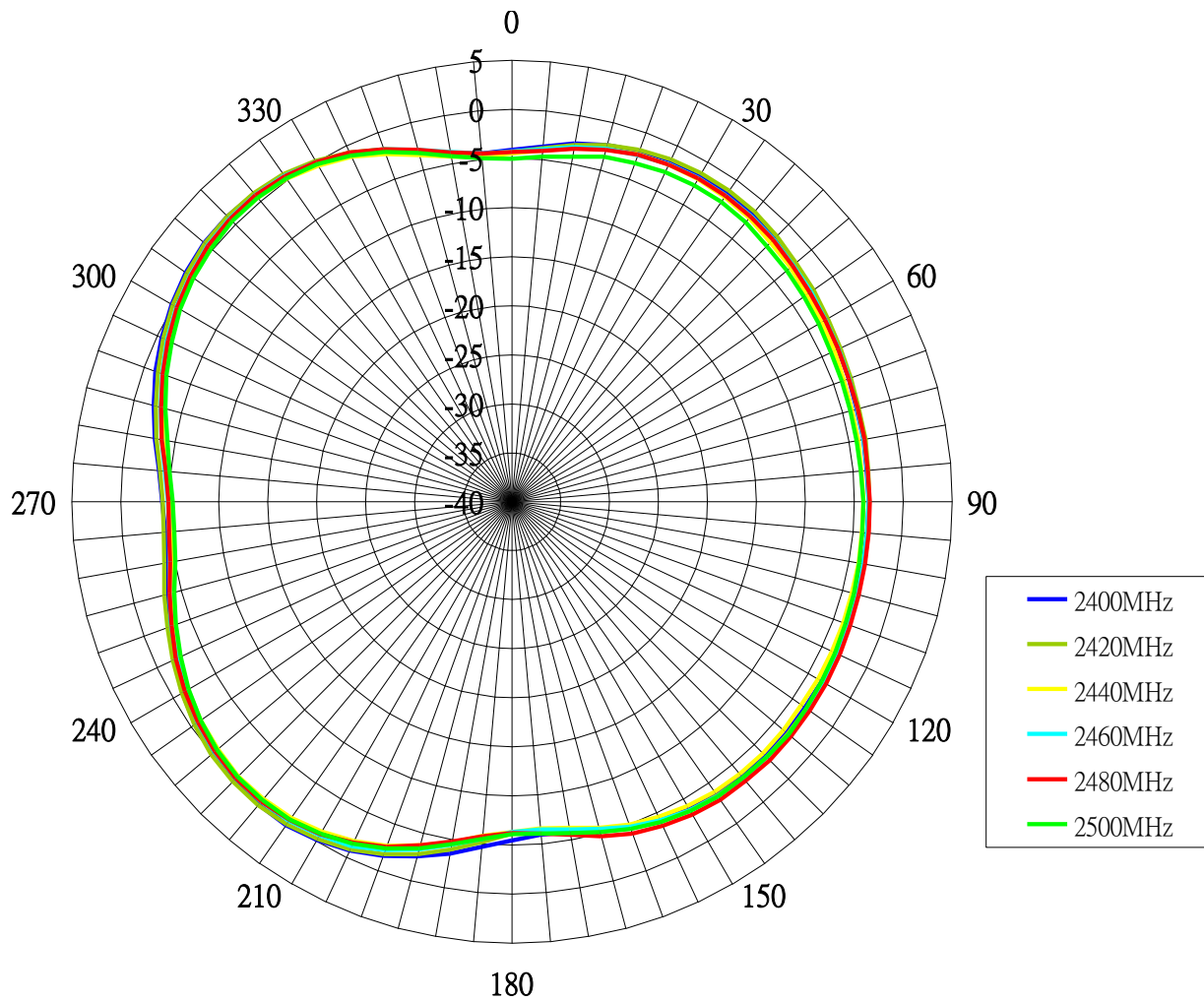

4.6 Antenna pattern (XZ plane)

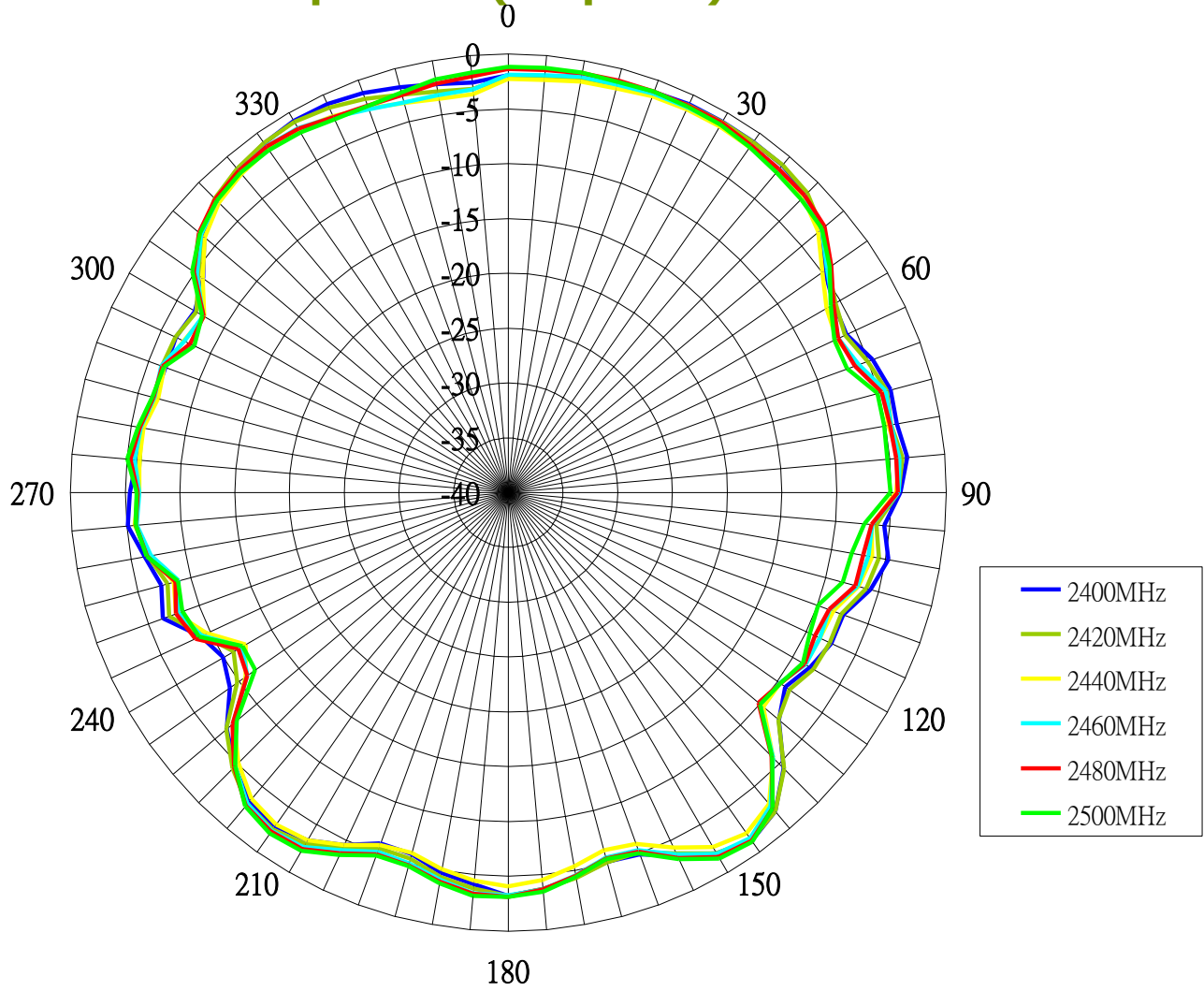

4.7 Antenna pattern (YZ plane)

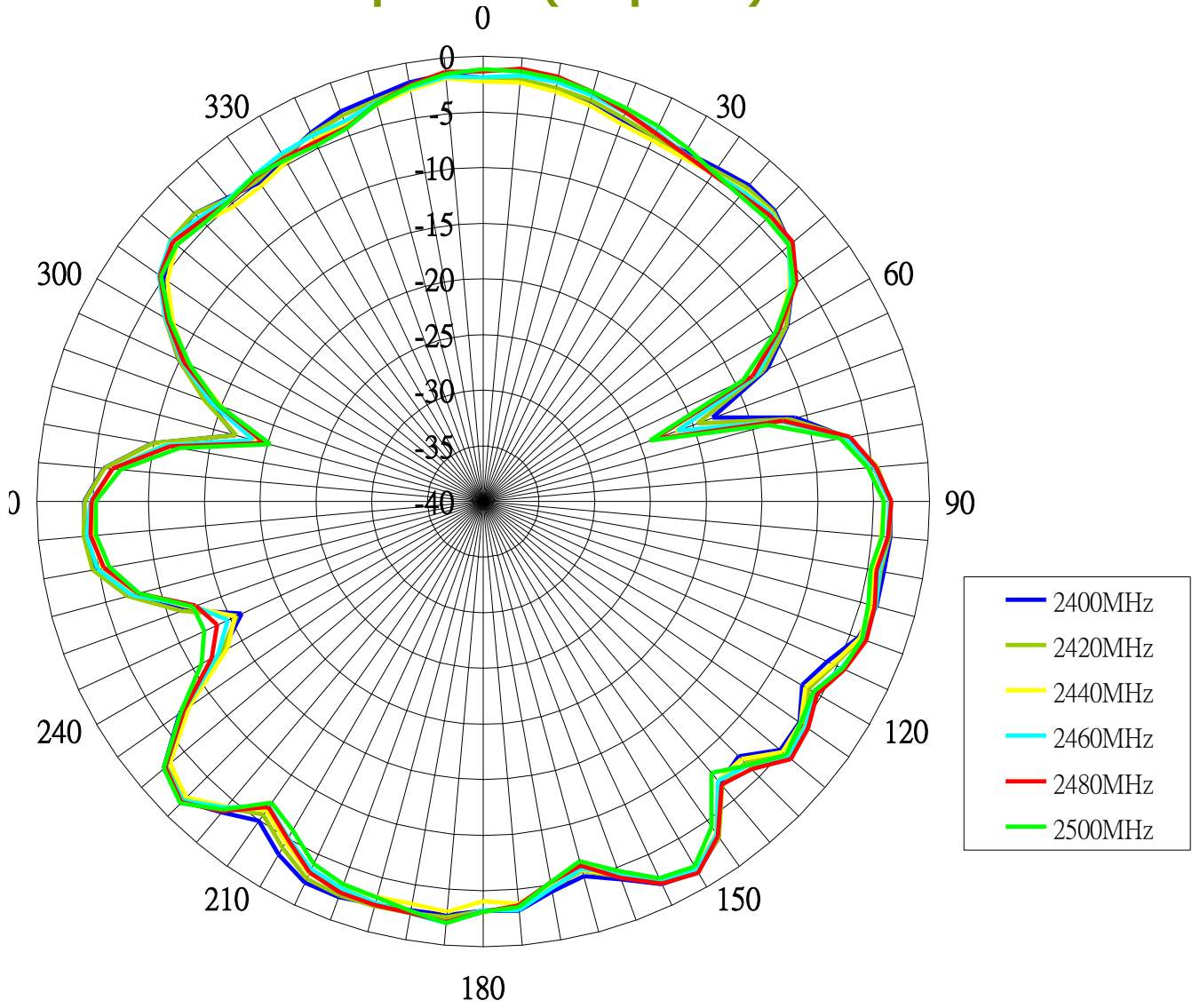

5. Outline Drawings and Structure

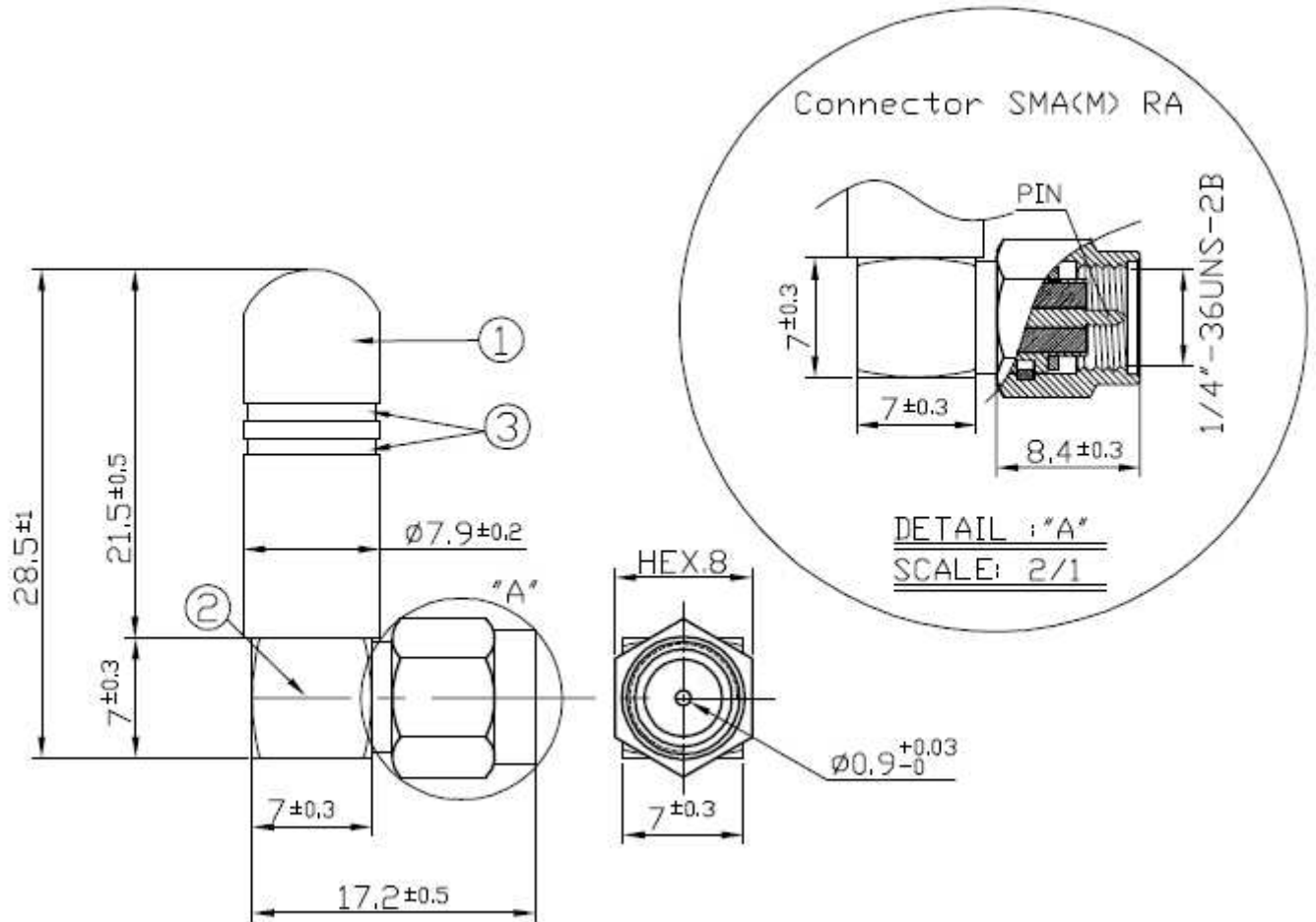

Key

1	Connector	SMA(M)RA Brass
2	Antenna Cover	TPEE (Black)
3	Colour Stripes	Apple Green - Acrylic Paint