

SPECIFICATION

- Part Number : **ILA.01**
- Product Name : Low Profile and High Efficient 915 MHz ISM Band Loop Antenna
- Features : Small size antenna, low profile and high efficiency
915 MHz ISM Band
1 dBi Peak Gain
10x3.2x0.5mm size
SMT Compatible
RoHS Compliant



1. INTRODUCTION

The ILA.01 has excellent stability and sensitivity to consistently provide high signal reception efficiency, 60% at centre frequency and 45% at the edges. Based on the loop effect this antenna works the best when placed on the centre of the edge of the board, working better than traditional linear polarized chip antennas. The antenna at 10x3.2x0.5 mm is low profile and would be suitable for devices with space constraints. The ILA.01 is delivered on tape and reel and now allows M2M customers to use an Omni-directional SMT antenna in devices where orientation of the product is unknown. The ILA.01 Loop antenna can be used in automated meter reading, (AMR), radio frequency identification (RFID), remote monitoring, healthcare, sensing and others.

2. SPECIFICATION

| ELECTRICAL | |
|---------------------------|------------------|
| ANTENNA | ILA.01 |
| STANDARD | 915 MHz ISM |
| Operation Frequency (MHz) | 902-928 MHz |
| Polarization | Linear |
| Impedance | 50 Ohms |
| Max VSWR (dBi) | 2:1 |
| Max Return Loss (dB) | -10 |
| Peak Gain | 1 dBi |
| Efficiency (%) | 50 |
| Average Gain (dB) | -3 |
| Radiation Properties | Omni-directional |
| Max Input Power | 5 W |

* The ILA.01 antenna performance was measured with 80x40 mm ground plane.

| MECHANICAL | |
|---------------------|------------|
| Dimensions (mm) | 10x3.2x0.5 |
| Required Space (mm) | 11x10.4 |
| Material | Ceramic |
| EVB Connector | SMA-Female |

| ENVIRONMENTAL | |
|-----------------------|----------------|
| Operation Temperature | -40°C to 85°C |
| Storage Temperature | -40°C to 105°C |
| Relative Humidity | 40% to 95% |
| RoHS Compliant | Yes |

3. TEST SET UP



Figure 1. Impedance measurements (left hand) and peak gain, average gain, efficiency and radiation pattern measurements (right hand)

4. ANTENNA PARAMETERS

4.1. Return Loss

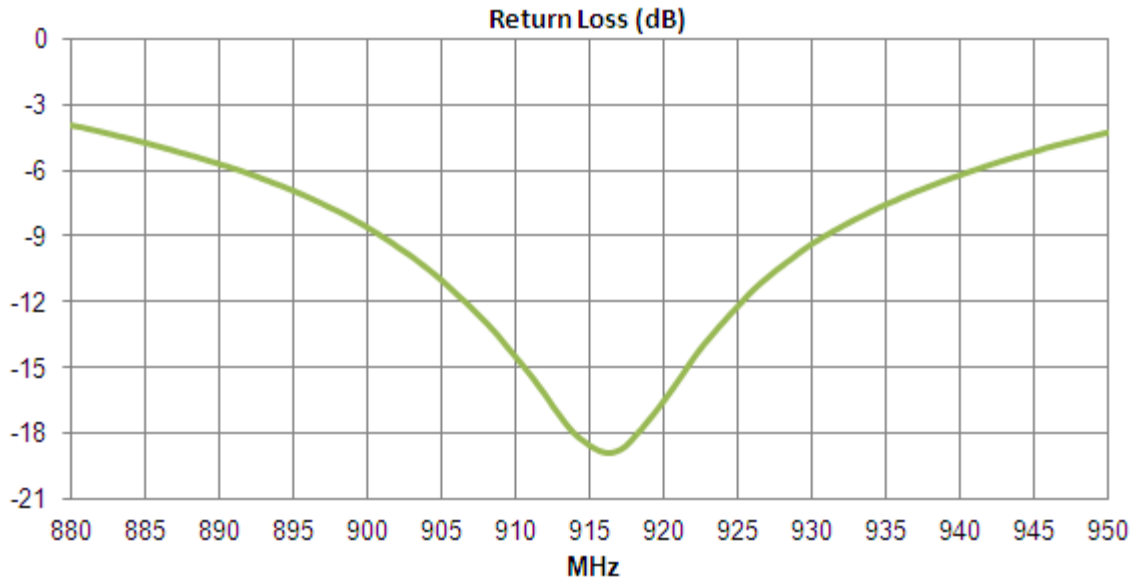

Figure 2. Return loss of 915MHz ISM Band Antenna ILA.01

4.2. VSWR

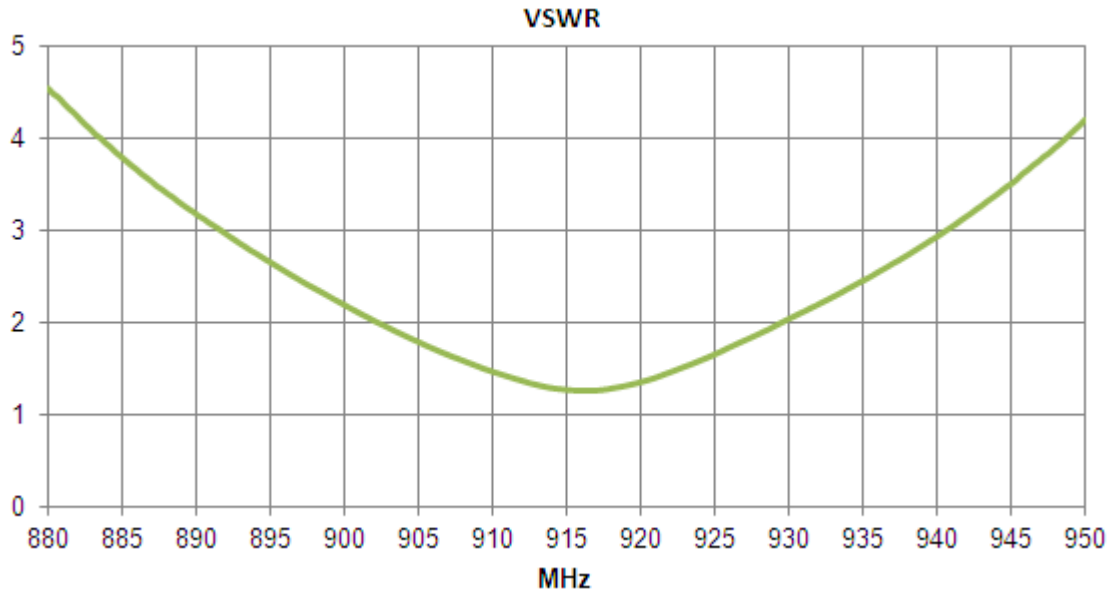

Figure 3. VSWR of 915 MHz ISM Band Antenna ILA.01

4.3. Efficiency

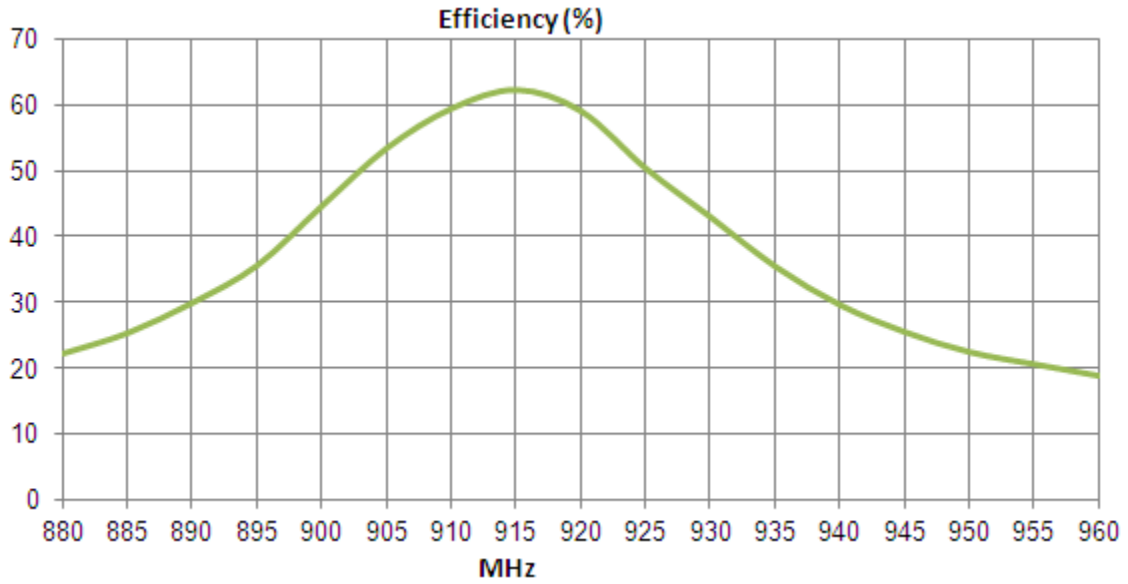

Figure 4. Efficiency of 915 MHz ISM Band Antenna ILA.01

4.4. Peak Gain

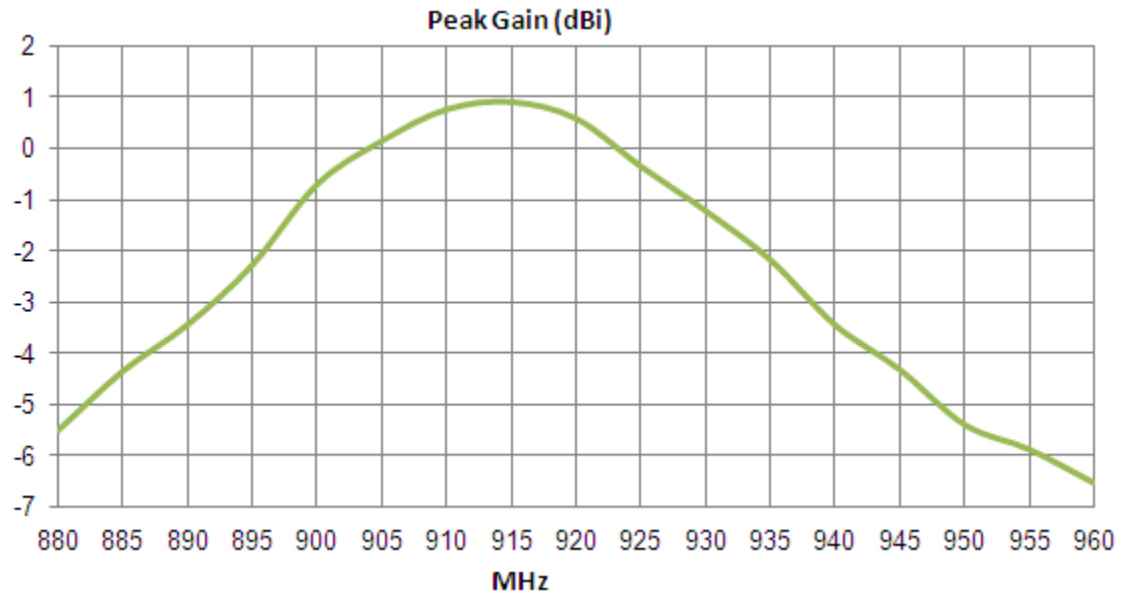

Figure 5. Peak Gain of 915 MHz ISM Band Antenna ILA.01

4.5. Average Gain

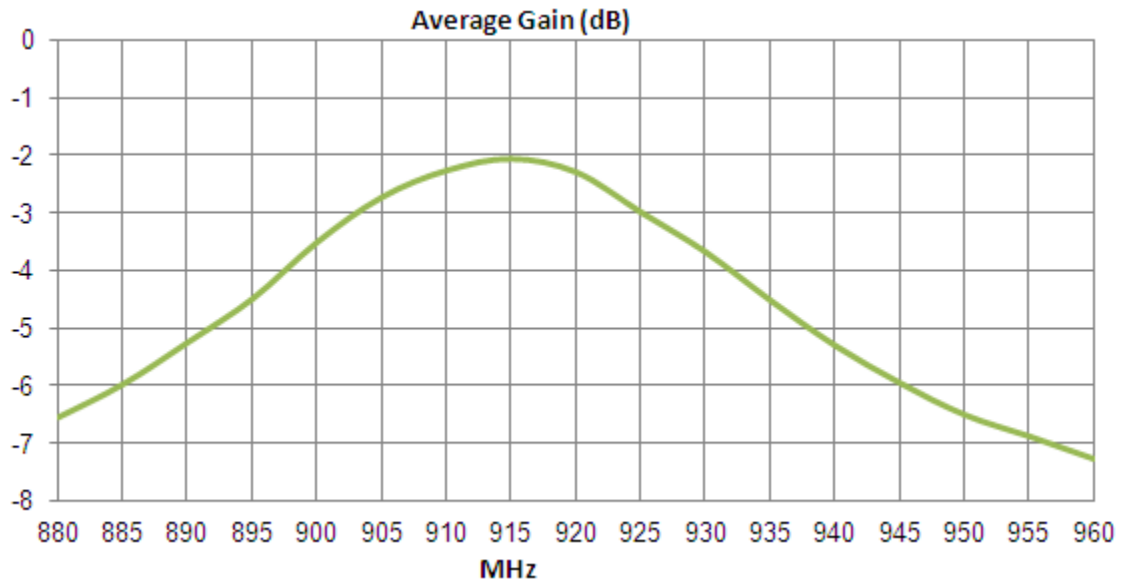

Figure 6. Average Gain of 915 MHz ISM Band Antenna ILA.01

IV.5. Radiation Pattern

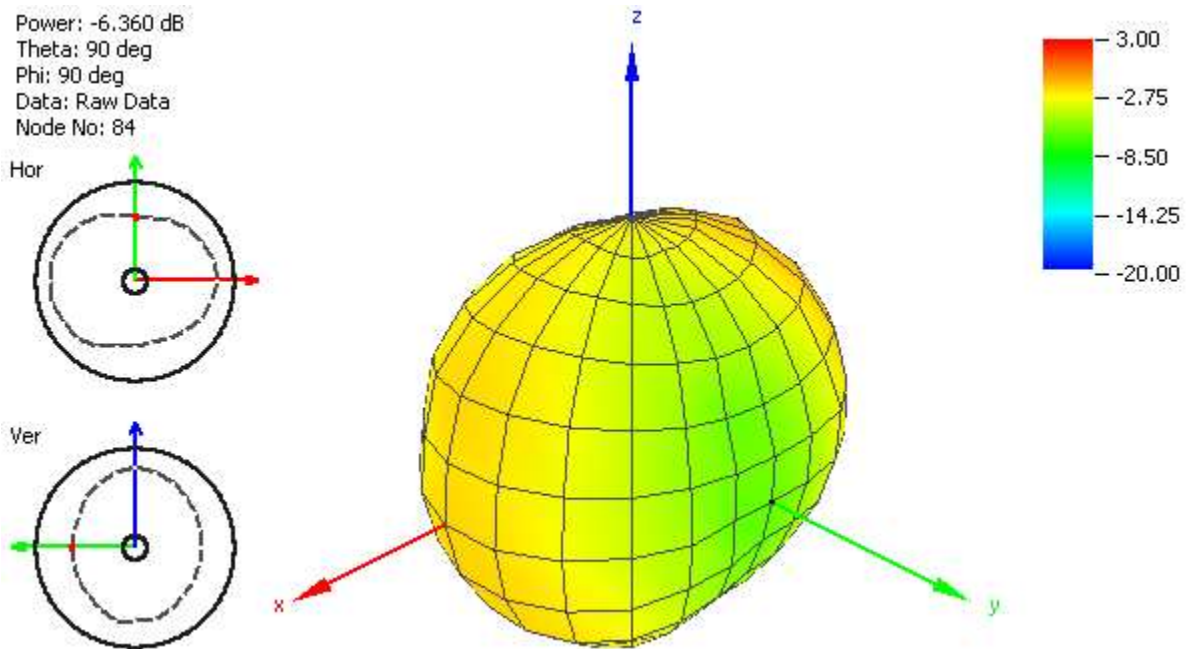

Figure 7. Radiation Pattern at 915 MHz of the ILA.01 Antenna.

5. MECHANICAL DRAWING

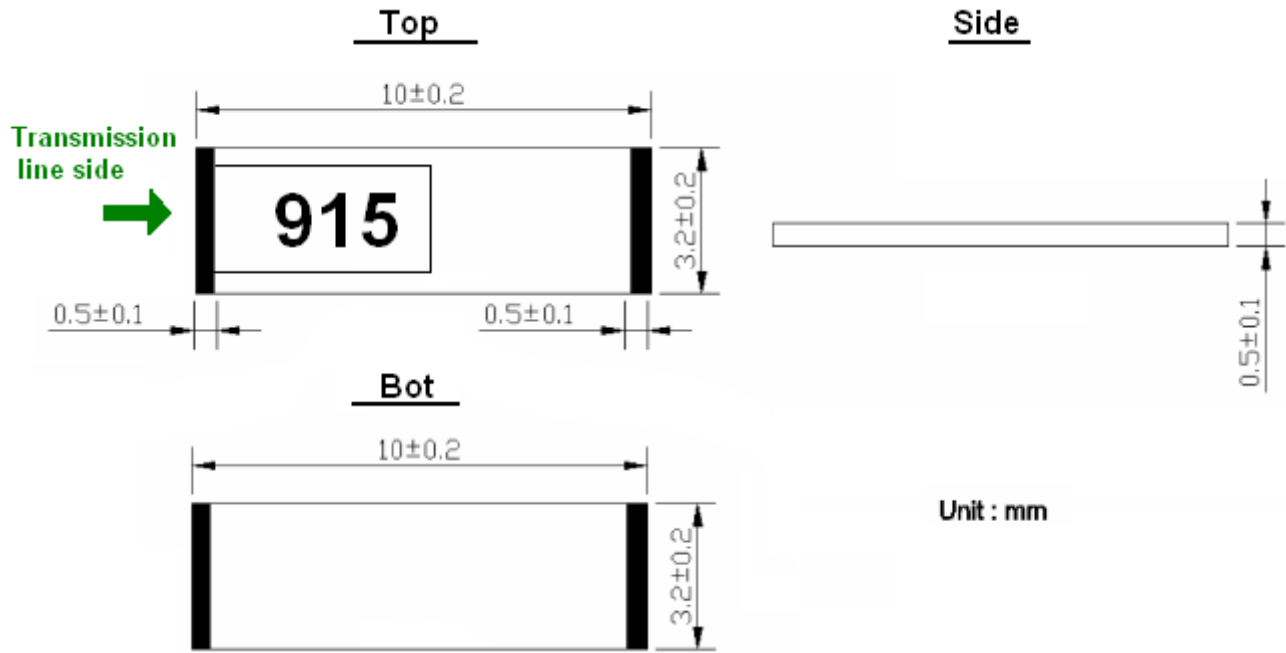
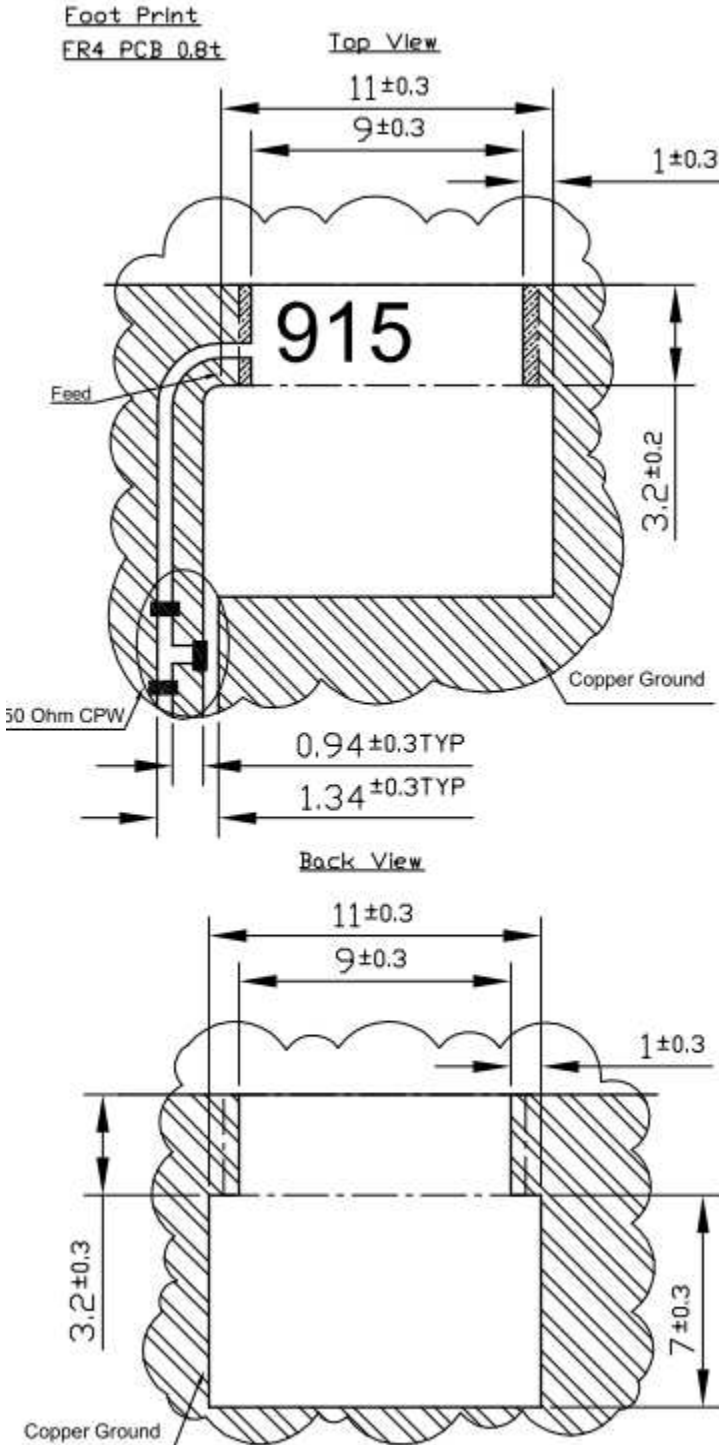

Figure 8. Mechanical Drawing of the ILA.01 Antenna

6. INTEGRATION GUIDE



NOTES:

1. Silver Area 
2. Logo & Text Ink Printing : Black
3.  Copper
4.  Soldered Area

6.1. Reference ground plane

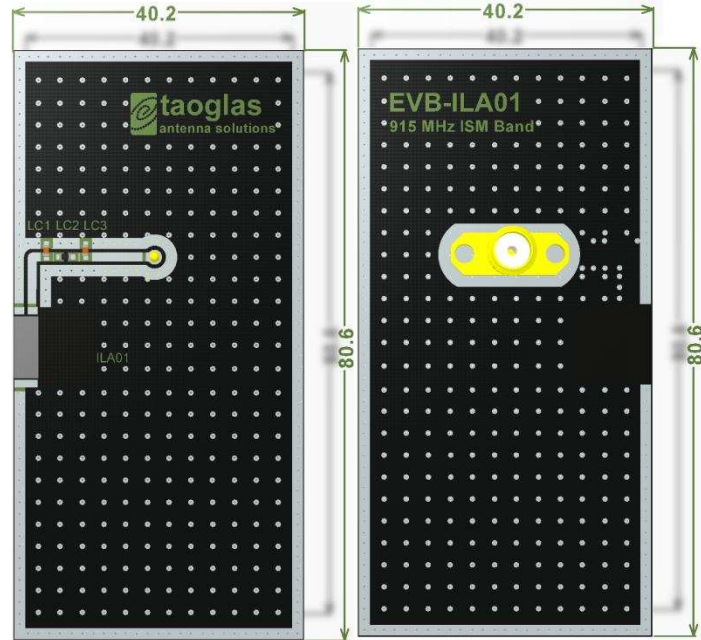

Figure 9. Test evaluation board with antenna. Top layer (left hand) and Bottom layer (right hand).

6.2. Solder Land Pattern

Land pattern for soldering is shown in gray, the keep out area of ground plane is shown in green.

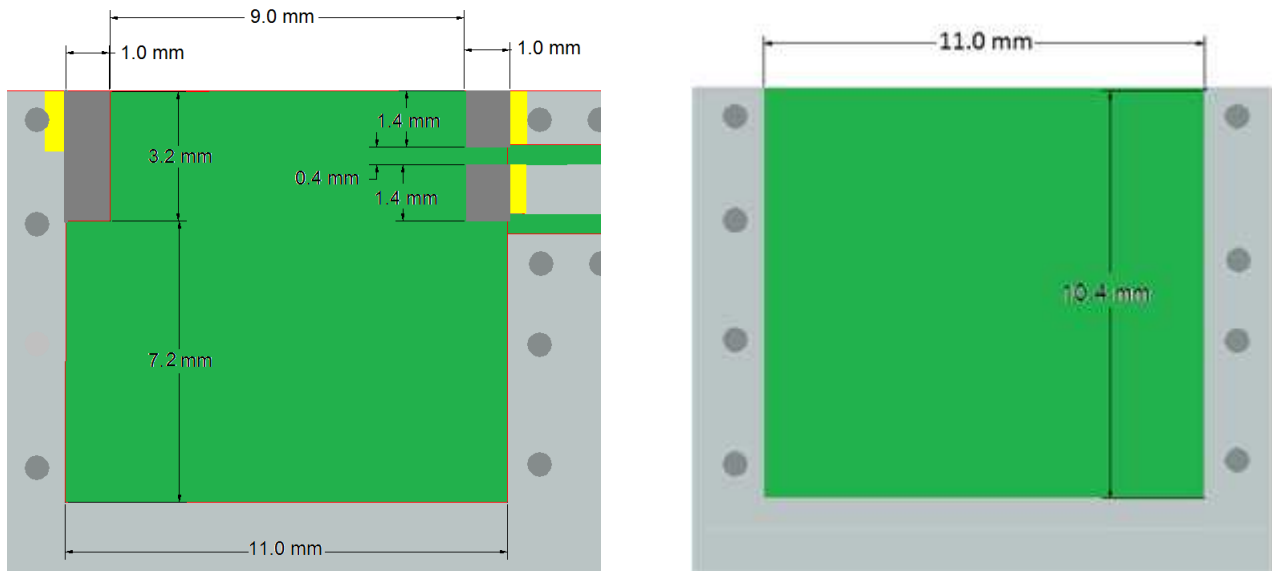

Figure 10. Solder Area and keep out area

6.3. Matching circuit

The initial matching circuit is $LC1 = 8.0 \text{ pF}$, $LC2 = 0\Omega$ and $LC3 = \text{open circuit}$. Unless the matching circuit might change depending on ground plane size-shape, PCB, enclosure-material proximity and others. We recommend contacting taoglas for tuning services.

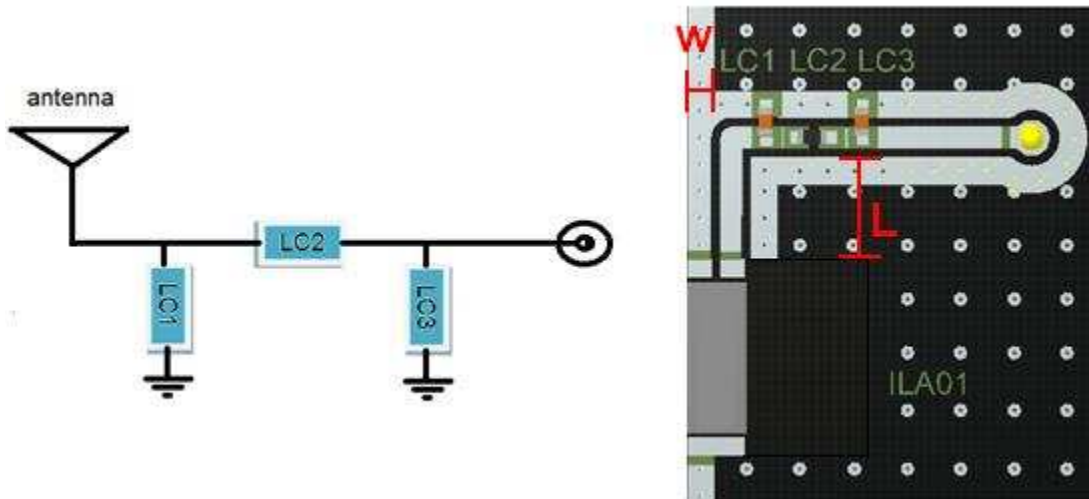

Figure 11. Recommended matching circuit

6.4. Recommendations

- Route the Co-Planar Waveguide (CPW) with curvy turns.
- Allocate the antenna on the longest side of the board.
- Center the antenna at the edge of the board.
- The antenna must be at the limit of the ground plane on the selected edge.
- Keep the "L" distance maximum 3 times the width of the CPW signal track, from the edge of the CPW ground to the keep out area of the antenna.
- Keep the matching circuit close to the antenna.
- Keep the "W" distance as the width of that GND pad.
- Keep the antenna 1 mm away from the enclosure.
- The CPW dimensions will change depending on PCB.
- Keep low profile components such as lumped, IC, etc, min 2 mm away from the edge of the keep out area or antenna, at top and bottom layers.
- Keep high profile components such as batteries, connectors, etc, 5 mm away from the edge of the keep out area or antenna, at top and bottom layers.

7. RECOMMENDED REFLOW TEMPERATURE PROFILE

The ILA01 Loop Antenna can be assembled following either Sn-Pb or Pb-Free assembly processes. The recommended soldering temperatures are as follows:

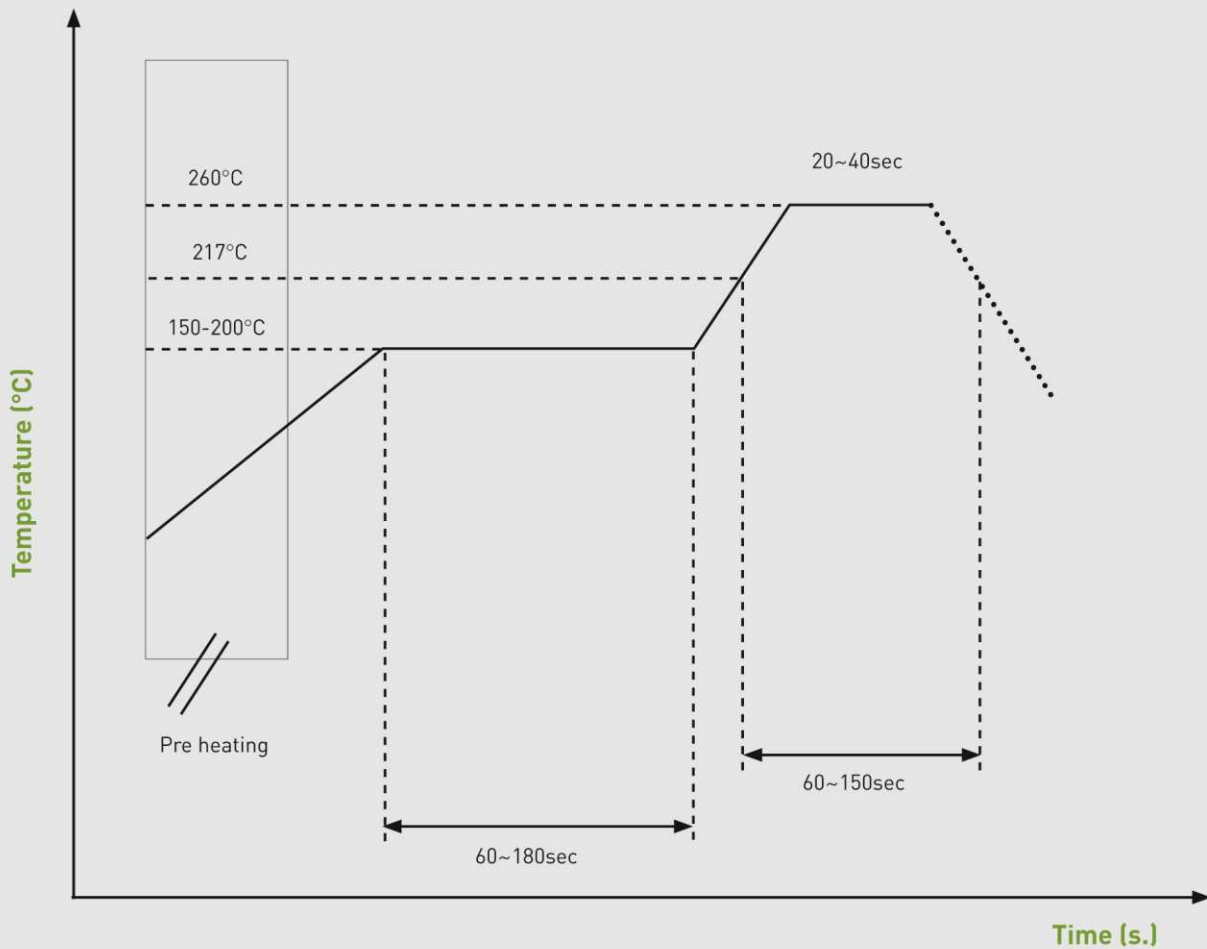

8. PACKAGING

The ILA.01 antennas are delivered in tape and reel with EIA 481-B polystyrene with 6000 pieces per reel.

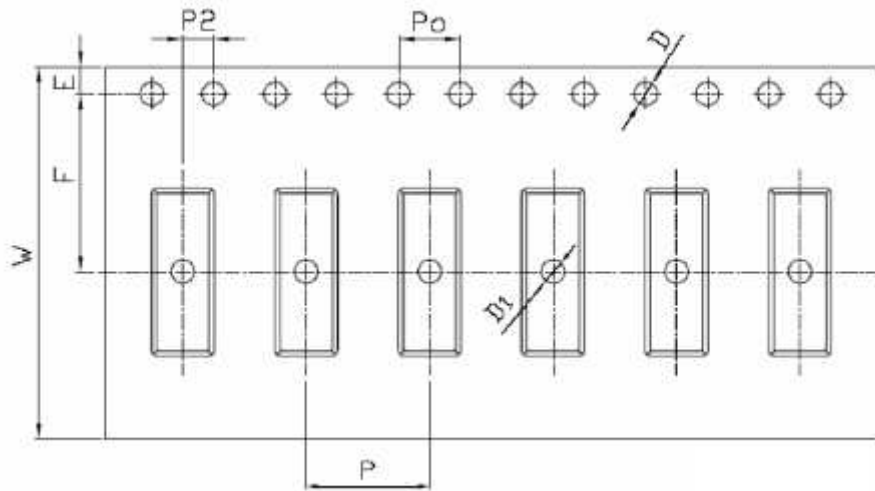

Figure 12. Tape description for the ILA.01

| Symbol | Spec |
|---------------|---------------|
| w | 24.0+/- 0.30 |
| P | 8.0+/- 0.10 |
| E | 1.75+/- 0.10 |
| F | 11.5+/- 0.10 |
| P2 | 2.0+/- 0.10 |
| D | 1.5+/- 0.10 |
| D1 | 1.5+/- 0.10 |
| Po | 4.0 +/- 0.10 |
| 10Po | 40 +/- 0.20 |
| Ao | 3.4 +/- 0.10 |
| Bo | 10.20+/- 0.10 |
| Ko | 0.7+/- 0.10 |
| t | 0.3+/- 0.05 |

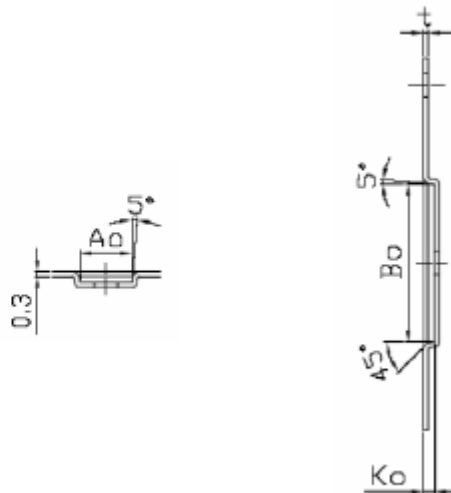

Figure 13. Tape dimensions for the ILA.01.