

PRODUCT SPECIFICATION

Product Name	5022 SMD POWER INDUCTORS - SHIELDED TYPE	Page	1
TAMURA Part No.	TS5022-XXX	Rev. No.	0

1. CONFIGURATION & DIMENSIONS :

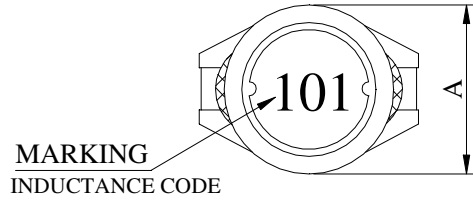

A :	15.00±0.3	m/m
B :	18.40±0.3	m/m
C :	7.00±0.5	m/m
D :	2.40±0.2	m/m
E :	2.20±0.2	m/m
F :	13.30±0.3	m/m
G :	12.70 REF.	m/m
H :	2.80 REF.	m/m
I :	3.00 REF.	m/m

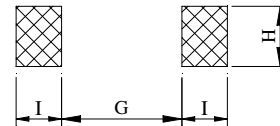
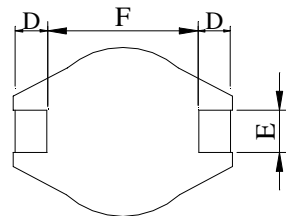
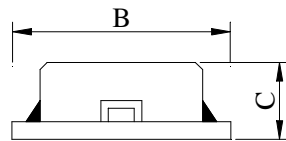

PCB PATTERN

2. SCHEMATIC DIAGRAM :

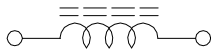

3. GENERAL SPECIFICATION :

- a) TEMP. RISE : 40°C MAX.
- b) RATED CURRENT : BASE ON TEMP. RISE & $\Delta L / LOA=10\%$ MAX.
- c) STORAGE TEMP. : -40°C ----+105°C
- d) OPERATING TEMP. : -25°C----+85°C
- e) RESISTANCE TO SOLDER HEAT : 260°C FOR 10 SECS.

PRODUCT SPECIFICATION

Product Name	5022 SMD POWER INDUCTORS - SHIELDED TYPE	Page	2
TAMURA Part No.	TS5022-XXX	Rev. No.	0

4. ELECTRICAL CHARACTERISTICS :

TAMURA Part No.	INDUCTANCE (μ H)	Q REF.	TEST FREQ. (HZ)		SRF (MHZ) TYP.	RDC (mOhm) MAX	IDC (A)
			L	Q			
TS5022-100M	10 \pm 20%	70	100K		20.0	30	4.00
TS5022-150M	15 \pm 20%	55	100K		17.0	35	3.60
TS5022-220M	22 \pm 20%	45	100K		15.0	45	3.15
TS5022-330M	33 \pm 20%	55	100K		10.0	60	2.80
TS5022-470M	47 \pm 20%	45	100K		8.5	80	2.45
TS5022-680M	68 \pm 20%	50	100K		6.5	115	2.00
TS5022-101M	100 \pm 20%	70	100K		5.5	180	1.70
TS5022-151M	150 \pm 20%	60	100K		5.0	220	1.35
TS5022-221M	220 \pm 20%	65	100K		4.0	320	1.15
TS5022-331M	330 \pm 20%	80	100K		3.0	500	0.90
TS5022-471M	470 \pm 20%	90	100K		2.5	750	0.75
TS5022-681M	680 \pm 20%	100	100K		2.3	1100	0.65
TS5022-102M	1000 \pm 20%	90	100K		1.9	1500	0.55



TAMURA

PRODUCT SPECIFICATION

Product Name	5022 SMD POWER INDUCTORS - SHIELDED TYPE	Page	3
TAMURA Part No.	TS5022-XXX	Rev. No.	0

RECOMMENDED SOLDERING CONDITIONS REFLOW SOLDERINGS

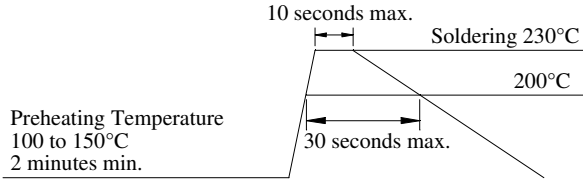

5. PACKAGING INFORMATION :

1. CONFIGURATION :

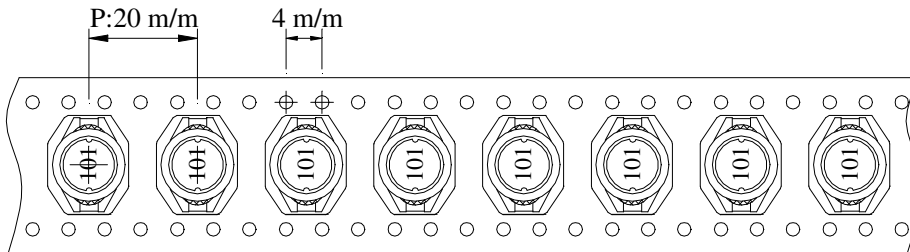
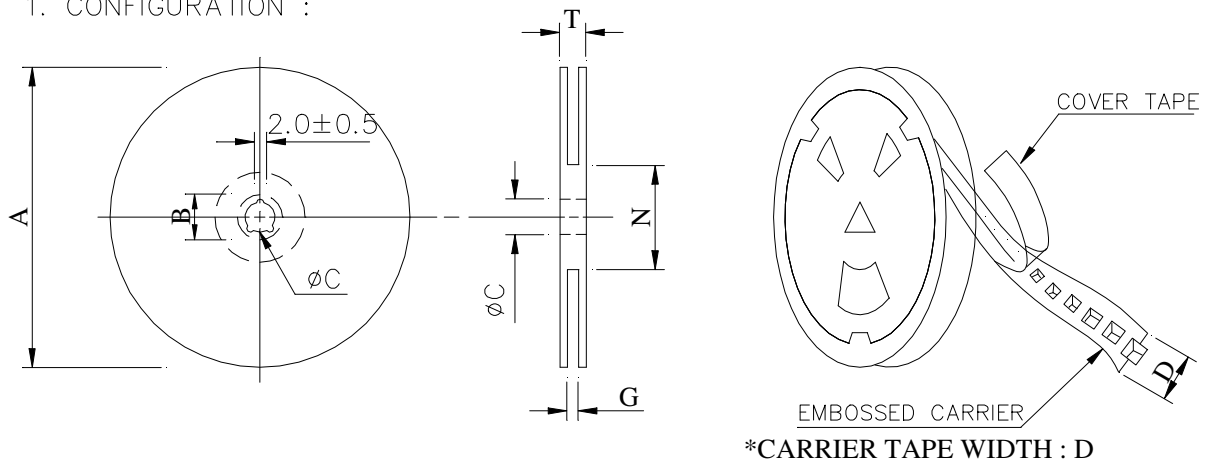

(2) DIMENSIONS

Unit:m/m

STYLE	A	B	C	D	G	N	T
13 - 32	330	21±0.8	13±0.5	32	34 MAX	100 MAX	38.4

(3) Q'TY & G.W. PER PACKAGE

SERIES	INNER : REEL			OUTER : CARTON		
	Q'TY (PCS)	G.W. (gw)	STYLE	Q'TY (PCS)	G.W. (Kg)	SIZE (cm)
TS5022	250	1250	13 - 32	1000	5	40 x 40 x 26



TAMURA

PRODUCT SPECIFICATION

Product Name	5022 SMD POWER INDUCTORS - SHIELDED TYPE	Page	4
TAMURA Part No.	TS5022-XXX	Rev. No.	0

6. Part No. FORMAT :

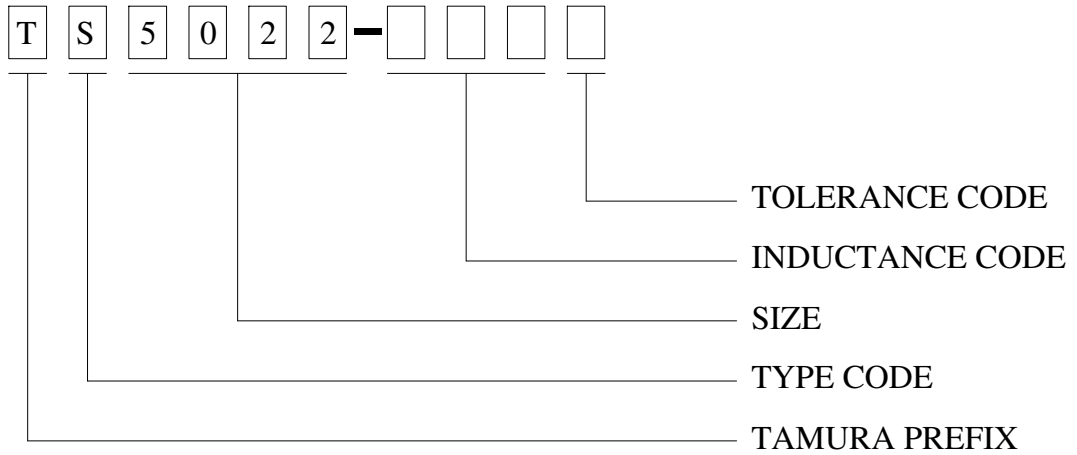

TAMURA

PRODUCT SPECIFICATION

Product Name	5022 SMD POWER INDUCTORS - SHIELDED TYPE	Page	5
TAMURA Part No.	TS5022-XXX	Rev. No.	0

7. RELIABILITY TEST :

TEST ITEM	SPECIFICATION	TEST CONDITION
SOLDERABILITY	MORE THAN 90% OF THE TERMINAL ELECTRODE SHALL BE COVERED WITH FRESH SOLDER.	PREHEAT : 125±25°C FOR 60 SECONDS SOLDER : H63A (EUTECTIC SOLDER) SOLDER TEMP. : 230±5°C FLUX : ROSIN DIP TIME : 4±1 SECONDS
THERMAL SHOCK TEST (TEMP. CYCLE)	INDUCTANCE SHALL NOT CHANGE MORE THAN ±20%	ROOM TEMP. —————> <u>-25±2°C</u> 15 MINUTES 30 MINUTES ROOM TEMP. —————> <u>85±2°C</u> 15 MINUTES 30 MINUTES TOTAL : 50 CYCLES
HUMIDITY RESISTANCE TEST		TEMPERATURE : 40±2°C HUMIDITY : 90 ~ 95% APPLIED CURRENT : PER SPEC. TIME : 500 HOURS
HIGH TEMP. RESISTANCE TEST		TEMPERATURE : 85±2°C APPLIED CURRENT : PER SPEC. TIME : 500 HOURS



TAMURA