

Specifications:

connector description (1)	6P mini DIN male, molding style, brass, nickel plating, P/N 50-00159
overmold (2)	inner: PE; outer: 60P, PVC, black
wire description (3)	6C, 20 AWG, UL2464, 300 V, 80 C, 7.0 mm, shielded, VW-1, PVC, 60P, P/N 30-00026
cable outer diameter	Ø7.0 mm
cable color	black
cable length	1830 ± 50 mm
twist tie (4)	black
shrink tube (5)	Ø7.0, 105°C, 10 ± 2 mm, black
shrink tube (6)	Ø1.0, 105°C, 30 ± 5 mm, black
current rating	2 A @ 12 Vdc

Notes:

Function test: no open, no reversed polarity, no short circuit, no INT
 RoHS compliant

Mechanical drawing:

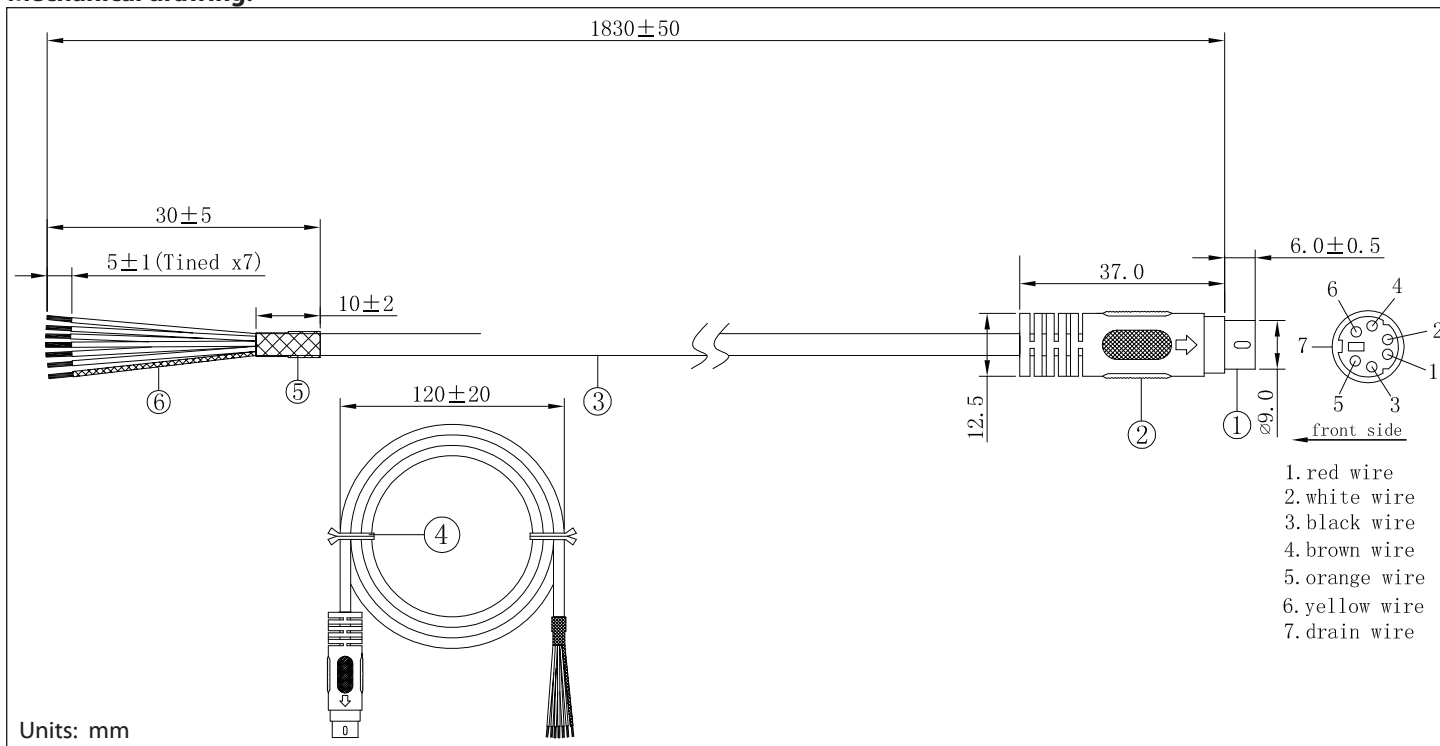

tolerance X: ±0.5 mm .X: ±0.3 mm .XX: ±0.05 mm
 applicable unless otherwise indicated in specification or on drawings

Tensility International Corporation reserves the right to substitute parts which are functionally equivalent to the ones specified.

Initial	Date
---------	------

Revision notes:

Rev	Date	Description
A	March 9, 2011	initial release

Specification Approval

Spec sign-off verifies that you have reviewed the entire specification, tested a sample of the product, and confirm that it meets your requirements. This specification reflects the part as it will be ordered. Orders will not be processed until the specification pages have been initialed and the approval page has been signed. This specification is confidential and is not to be transmitted without prior approval from Tensility.

Signature _____ Title _____
 Name _____ Date _____
 Company _____ Branch _____