

### Specifications:

connector description (1)	8P standard DIN male, molding style, brass, nickel plating, 270°, P/N 50-00175
overmold (2)	inner: PE; outer: 60P, PVC, black
wire description (3)	8C, 20 AWG, UL2464, 300 V, 80 C, 8.0 mm, shielded, VW-1, PVC, 60P, P/N 30-00028
cable outer diameter	Ø8.0 mm
cable color	black
cable length	1830 ± 50 mm
twist tie (4)	black
shrink tube (5)	Ø8.0, 105°C, 10 ± 2 mm, black
shrink tube (6)	Ø1.0, 105°C, 30 ± 5 mm, black
current rating	2 A @ 12 Vdc

### Notes:

Function test: no open, no reversed polarity, no short circuit, no INT  
 RoHS compliant

### Mechanical drawing:

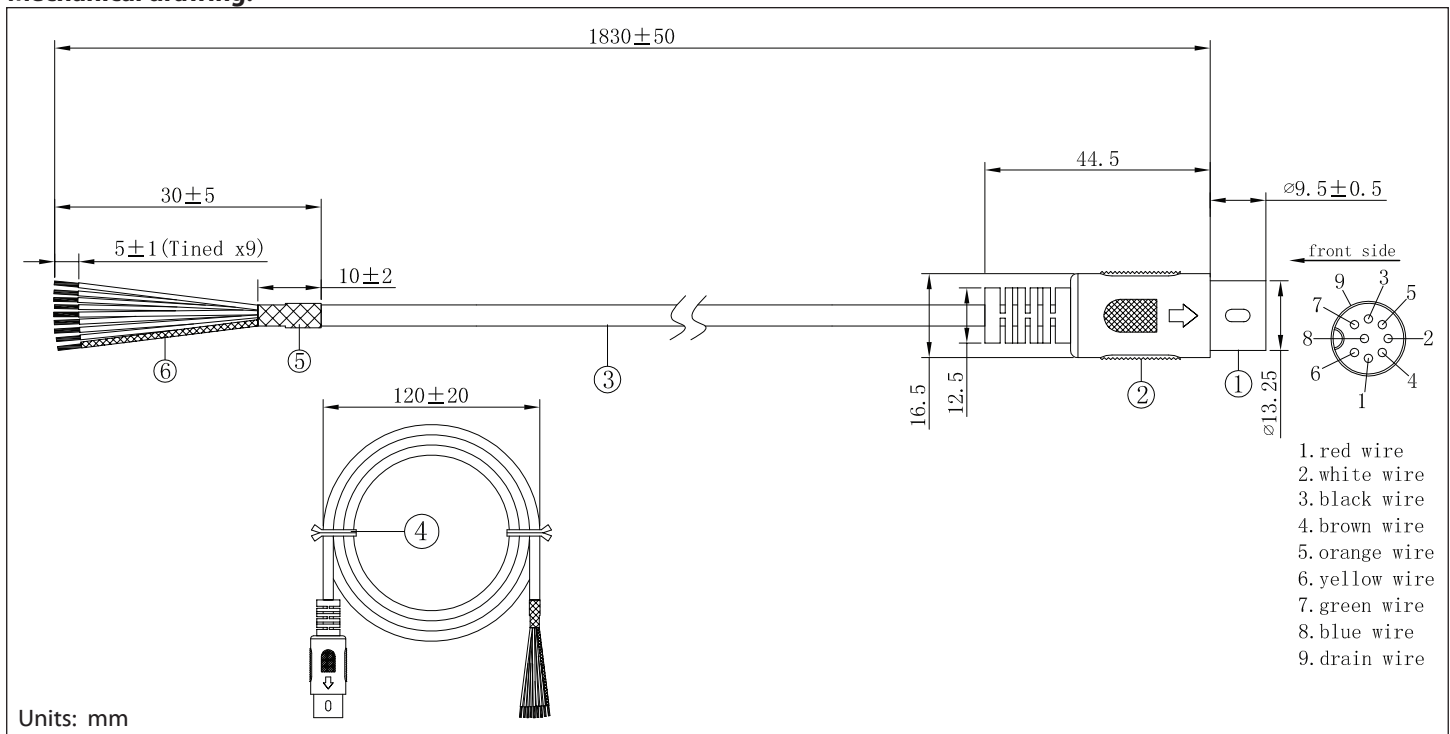

**tolerance X: ±0.5 mm .X: ±0.3 mm .XX: ±0.05 mm**  
 applicable unless otherwise indicated in specification or on drawings  
 Tensility International Corporation reserves the right to substitute parts which are functionally equivalent to the ones specified.

Initial	Date
---------	------

**Revision notes:**

Rev	Date	Description
A	March 8, 2011	initial release

**Specification Approval**

Spec sign-off verifies that you have reviewed the entire specification, tested a sample of the product, and confirm that it meets your requirements. This specification reflects the part as it will be ordered. Orders will not be processed until the specification pages have been initialed and the approval page has been signed. This specification is confidential and is not to be transmitted without prior approval from Tensility.

Signature \_\_\_\_\_

Title \_\_\_\_\_

Name \_\_\_\_\_

Date \_\_\_\_\_

Company \_\_\_\_\_

Branch \_\_\_\_\_